

# AQUA DESIGNER 9.2

## Manual

Software for Design of  
Wastewater Treatment Plants

© by BITControl

BITControl	AQUA DESIGNER 9.2 - Manual	Seite: 2 von 314
	1 Preface	Version: <b>92-00</b>

### Liability Limitation

The information and data in this publication can be changed without preliminary notice by the publisher at any time.

No part of this publication may be copied, reproduced or transmitted for any purpose, in any form or by any means, regardless whether electronical or mechanical without the written permission of Aqua Office.

The present software was carefully designed and tested. Nevertheless we cannot guarantee it being completely error-free. Furthermore we stress that the responsibility of the plant designer is not transferred on the program or programmer by using the AQUA DESIGNER Software for plant design.

在不提前通知客户的前提下本公司仍然享有对软件内数据和说明进行更改的权利。没有BITControl公司的明确授权本软件的任何部分不得以任何目的任何方式进行复制与转载。本软件已进行了认真地设置与调试。然而我们不能完全保证本软件没有任何纰漏。此外特别提示您，由于错误操作所造成的损失本公司不承担任何连带责任。

© BITControl GmbH, Nattenheim, Germany

All rights reserved

Document: Manual  
Software: AQUA DESIGNER 9.2  
Ersteller: Norbert Meyer  
Brigitte Jegen  
Erstelldatum: 23.08.2016  
Version: 92-00 vom 23.08.2023  
BITControl GmbH  
Auf dem Sauerfeld 20  
54636 Nattenheim

# 1 Preface

Welcome to AQUA DESIGNER, the new efficient tool for the design of wastewater plants. This software offers extensive help to solve routine tasks quickly and reliably. It will, thus, leave you time to spend on the more conceptional and creative aspects of your work.

All calculation routines and variations have been thoroughly verified to ensure endorsement of your chosen concepts. You will save unexpected meetings and unnecessary feedback questions.

The supplemental part of the program in the 'Extras' allows an economic comparison of the choices. Furthermore, extensive information for the subsequent design phases are supplied to you.

You will come to realise how easily and quickly effects of design changes can be reviewed and how they affect different parameters, e.g. effect on the activated sludge and secondary treatment through correlated changes in dry matter concentration and choice of a phosphate precipitation. Within minutes you will be able to determine the most economic choice through mass evaluation and evaluation of operating expenses. Your contractors will be convinced by the efficient design.



## 2 Content

<b>1</b>	<b>PREFACE</b> .....	<b>1</b>
<b>2</b>	<b>CONTENT</b> .....	<b>2</b>
<b>3</b>	<b>INTRODUCTION</b> .....	<b>7</b>
3.1	<b>AQUA DESIGNER 1.0 to 8.x</b> .....	<b>8</b>
3.2	<b>AQUA DESIGNER 9.x</b> .....	<b>9</b>
3.3	<b>Conventions</b> .....	<b>9</b>
3.4	<b>System Requirements</b> .....	<b>10</b>
3.5	<b>Scope of Delivery</b> .....	<b>10</b>
3.6	<b>Software Installation</b> .....	<b>10</b>
3.7	<b>Starting AQUA DESIGNER</b> .....	<b>10</b>
<b>4</b>	<b>HANDLING</b> .....	<b>12</b>
4.1	<b>Menu Bar</b> .....	<b>12</b>
4.2	<b>Main Form</b> .....	<b>14</b>
4.3	<b>Fields and Boxes</b> .....	<b>16</b>
4.4	<b>Keyboard Functions</b> .....	<b>17</b>
<b>5</b>	<b>FIRST STEPS</b> .....	<b>19</b>
5.1	<b>Demo Mode</b> .....	<b>19</b>
5.2	<b>Introduction</b> .....	<b>19</b>
5.3	<b>Calculation based on DWA-A 131</b> .....	<b>20</b>
5.3.1	Waste Water Load .....	21
5.3.2	Secondary Sedimentation Tank .....	22
5.3.3	Clarified Water Outlet .....	24
5.3.4	Basic Data .....	25
5.3.5	Multiple Lines .....	26
5.3.6	Activated Sludge Tank .....	27
5.3.7	Aeration .....	28
5.3.8	Sludge Recirculation .....	31
5.3.9	Save Data .....	32
5.3.10	Sludge Storage .....	33
5.3.11	Design Assembly .....	34
<b>6</b>	<b>THEORY</b> .....	<b>37</b>
6.1	<b>Activated Sludge System</b> .....	<b>37</b>
6.1.1	Constituents .....	37
6.1.2	History .....	37
6.1.3	Description of Operation .....	39
6.2	<b>Loading and Sludge Age</b> .....	<b>40</b>
6.3	<b>Decomposition of Organic Matter</b> .....	<b>41</b>
6.4	<b>Nitrogen Decomposition</b> .....	<b>42</b>
6.5	<b>Phosphorus Decomposition</b> .....	<b>44</b>

<b>7</b>	<b>DIMENSIONING</b> .....	<b>46</b>
7.1	Introduction .....	46
7.2	Dimensioning Limits .....	46
7.3	Loading .....	47
7.3.1	Load DWA .....	48
7.3.2	Load MSIG or M&E .....	53
7.3.3	Internal Response .....	55
7.3.4	Industrial Loads .....	59
7.3.5	Total Load .....	60
7.3.6	Pre Sedimentation .....	60
7.3.7	Overview of material flows .....	60
7.4	Choosing a Guideline .....	61
7.5	Clarification Method .....	63
7.5.1	Only Carbon Degradation .....	64
7.5.2	Only Nitrification .....	65
7.5.3	Nitrification and Denitrification .....	66
7.5.4	External C-Dosage .....	79
7.5.5	Simultaneous Aerobic Sludge Stabilization .....	86
7.6	Parameter Activated Sludge Process .....	88
7.6.1	Organic Load and Sludge Volume Index .....	88
7.6.2	MLSS-Concentration / Activated Sludge Tank .....	89
7.6.3	MLSS-Concentration / Influent .....	90
7.6.4	Sludge Age and Excess Sludge .....	91
7.6.5	Sludge and Volume Load .....	93
7.6.6	Activated Sludge Tank Volume Requirements .....	94
7.6.7	Return Sludge Ratio .....	95
7.6.8	Nitrification .....	96
7.6.9	Denitrification .....	96
7.6.10	Phosphate Removal .....	98
7.6.11	Total Waste Sludge Production .....	104
7.7	University Algorithm .....	105
7.7.1	Scope .....	106
7.7.2	Variation of Method .....	106
7.7.3	Inflow .....	108
7.7.4	Outflow Requirements .....	108
7.7.5	Calculative Algorithm .....	109
7.7.6	Constant Values .....	114
7.8	MSIG .....	115
7.9	Continuous Flowed Activated Sludge System .....	117
7.9.1	Upstream Anaerobic Chamber .....	117
7.9.2	Upflow Aerobic Selector .....	119

7.9.3	Secondary Sedimentation Tank.....	122
7.9.4	Clarified Water Outlet .....	141
7.9.5	Activated Sludge Tank.....	143
7.9.6	Dimensioning of Aeration.....	153
7.9.7	Technique of Aeration.....	168
7.9.8	Return Sludge Transport .....	180
<b>7.10</b>	<b>Membrane System .....</b>	<b>181</b>
7.10.1	Construction Types .....	181
7.10.2	Return Sludge and Recirculation .....	183
7.10.3	Design of the Membrane Units .....	183
7.10.4	Design of the Activated Tanks .....	186
7.10.5	Disinfection.....	188
<b>7.11</b>	<b>Sequencing Batch Reactor .....</b>	<b>188</b>
7.11.1	Process and Operational Variations .....	189
7.11.2	Cycle Period.....	189
7.11.3	Reactor Volume.....	191
<b>7.12</b>	<b>Completed Computation .....</b>	<b>199</b>
<b>7.13</b>	<b>Grit Chamber Design .....</b>	<b>200</b>
7.13.1	Dimensioning .....	200
7.13.2	Equipment.....	206
<b>8</b>	<b>DATA BANK.....</b>	<b>211</b>
<b>8.1</b>	<b>Pumps.....</b>	<b>213</b>
<b>8.2</b>	<b>Mixer .....</b>	<b>215</b>
<b>8.3</b>	<b>Blower.....</b>	<b>217</b>
<b>9</b>	<b>PROJECT DATA BANK .....</b>	<b>219</b>
<b>10</b>	<b>MENU REPORT.....</b>	<b>220</b>
<b>10.1</b>	<b>Operation.....</b>	<b>220</b>
<b>10.2</b>	<b>Description.....</b>	<b>221</b>
<b>10.3</b>	<b>Dimensioning.....</b>	<b>221</b>
<b>10.4</b>	<b>Calculation of the Grit Chamber .....</b>	<b>222</b>
<b>10.5</b>	<b>Short Print.....</b>	<b>223</b>
<b>10.6</b>	<b>Individual Results .....</b>	<b>223</b>
<b>10.7</b>	<b>Machine List – Excel Export.....</b>	<b>223</b>
<b>10.8</b>	<b>Machine List – XML Export .....</b>	<b>223</b>
<b>10.9</b>	<b>Supplementary Calculations .....</b>	<b>223</b>
<b>11</b>	<b>MENU SLUDGE TREATMENT.....</b>	<b>226</b>
<b>11.1</b>	<b>Thickener.....</b>	<b>226</b>
<b>11.2</b>	<b>Sludge Tank .....</b>	<b>227</b>
<b>11.3</b>	<b>Anaerobic Sludge Digestion .....</b>	<b>229</b>
11.3.1	General .....	229
11.3.2	Handling.....	230

11.3.3	Activated and Thickened Sludge.....	230
11.3.4	Anaerobic Digestion.....	231
<b>11.4</b>	<b>Separate Aerobic Sludge Stabilization .....</b>	<b>233</b>
11.4.1	Material Balances for Thickening .....	235
11.4.2	Separate aerobic Sludge Stabilization .....	236
11.4.3	Separate aerobic thermophilic stabilization .....	237
<b>11.5</b>	<b>Sludge Balance .....</b>	<b>238</b>
<b>12</b>	<b>MENU EXTRAS .....</b>	<b>240</b>
<b>12.1</b>	<b>Components .....</b>	<b>240</b>
<b>12.2</b>	<b>Operational Costs .....</b>	<b>240</b>
12.2.1	Control Keys .....	240
12.2.2	Energy Costs .....	241
12.2.3	Sludge Disposal.....	247
12.2.4	Personnel Costs .....	249
12.2.5	Total Operation Costs.....	250
12.2.6	Benefits of Anaerobic Digestion .....	250
<b>12.3</b>	<b>Load Variation .....</b>	<b>250</b>
<b>12.4</b>	<b>Pipelines .....</b>	<b>251</b>
<b>12.5</b>	<b>Oxygen Efficiency .....</b>	<b>252</b>
<b>13</b>	<b>MENU DRAWINGS .....</b>	<b>256</b>
<b>13.1</b>	<b>Drawings.....</b>	<b>256</b>
13.1.1	Fields.....	258
13.1.2	Membrane Aeration System.....	264
13.1.3	Control Picture .....	265
13.1.4	Output of Drawings .....	265
<b>13.2</b>	<b>Flow diagram .....</b>	<b>266</b>
13.2.1	Grit and Grease Chamber, Primary Sedimentation and biological Trap 266	
13.2.2	Further process units .....	266
13.2.3	Export.....	267
<b>13.3</b>	<b>Mass Calculation.....</b>	<b>267</b>
<b>13.4</b>	<b>Bouyancy.....</b>	<b>270</b>
<b>14</b>	<b>MENU VERIFY .....</b>	<b>271</b>
<b>14.1</b>	<b>Generell.....</b>	<b>271</b>
<b>14.2</b>	<b>Secondary Sedimentation Tank .....</b>	<b>271</b>
14.2.1	Calculation .....	271
14.2.2	Proof.....	273
14.2.3	Hints .....	274
<b>15</b>	<b>MENU OPTIONS.....</b>	<b>276</b>
<b>15.1</b>	<b>Language.....</b>	<b>276</b>
<b>15.2</b>	<b>Settings.....</b>	<b>276</b>

15.2.1	Options.....	276
15.2.2	Documentation .....	282
15.2.3	Operation Costs .....	283
15.2.4	Export to Word .....	283
15.2.5	Message Window .....	284
<b>15.3</b>	<b>Process .....</b>	<b>284</b>
15.3.1	Nutrient Elimination .....	284
15.3.2	Basis of Design A 131 .....	285
15.3.3	Aeration.....	285
15.3.4	Standards.....	285
<b>15.4</b>	<b>General Constants .....</b>	<b>286</b>
15.4.1	Generell .....	286
15.4.2	Load .....	287
15.4.3	Nitrogen Balance.....	288
15.4.4	Sludge Treatment.....	288
15.4.5	Buildings / Equipment.....	289
15.4.6	Precipitant .....	290
<b>15.5</b>	<b>Constants COD .....</b>	<b>290</b>
<b>15.6</b>	<b>Constants Hochschulgruppe .....</b>	<b>291</b>
<b>15.7</b>	<b>Details.....</b>	<b>292</b>
<b>16</b>	<b>FORMULARIC SYMBOLS.....</b>	<b>294</b>
<b>17</b>	<b>LITERATURE .....</b>	<b>300</b>
<b>18</b>	<b>SERVICE .....</b>	<b>312</b>



## 3 Introduction



Very few programs exist for dimensioning the biological step of wastewater plants. The few that exist have mostly been created at universities and are restricted to very basic values of dimensioning. **AQUA DESIGNER was designed by engineers with practical experience in plant design and equipment and can now look back on 20 years of continuous development.** Thus, this program incorporates a variety of functions that instantly facilitates the design of wastewater plants.

The dimensioning in AQUA DESIGNER is based on the DWA (Abwasser Technische Vereinigung) directions, in particular the DWA A226, DWA A131 and M210. The directions for calculations are not complicated. Only calculating the sludge loading rate based on the A131 directions requires an iterative calculation. However, calculating different choices and variations manually and investigating different clarifying processes is a tedious task.

Also, mistakes are barely avoidable with numerous calculations.

Investigating the effect of calculations on building construction requires tremendous effort which is both costly and time consuming.

**In AQUA DESIGNER, all meaningful choices are calculated within minutes and are immediately evaluated for effectiveness. For every choice, production costs, masses, flotation and scaled drawings are readily available.**

In addition, AQUA DESIGNER provides a detailed design layout that liberates you from the task of writing the documentation of your chosen concepts. **A detailed documentation is automatically generated and can be exported to Word and Excel.**

**Scaled graphic designs and - as a new function - a flow sheet are produced in the shortest time for an impressive presentation.** These graphics can also be printed in colour, or copied to other applications. Additional diagrams within the dimensioning allow you to examine the current calculation status.

The handbook offers the most complete overview possible on the AQUA

DESIGNER program.

### 3.1 AQUA DESIGNER 1.0 to 8.x

**AQUA DESIGNER 1.0** offered new concepts compared to previous dimensioning programs. Structure and tools of the program are strictly adjusted to practical work and result in a comprehensive design package.

**AQUA DESIGNER 2.0** added several variations as like multiple lines, more tank types and specific tools requested by customers.

**AQUA DESIGNER 3.x** now offers all applicable methods of the activated sludge clarification process, it offers further improvements in the design drawings and some new tools. In particular the design of plants without sludge stabilisation and plants on the basis of SBR, sequencing batch reactors, have been included.

The main new feature in **AQUA DESIGNER 4.0** is the implementation of the new regular ATV A131. This includes a lot of new operation steps like aerobic selector and scrapper-dimensioning and the dimensioning based on the COD. Furtheron there are new variants of aeration and new languages. Now you can chose german, english, polish, tschechisch and hungary.

In the version **AQUA DESIGNER 5.x** you will find cascaded denitrification, enhanced function to included turbid water reflow, load variation and of course a lot of improvements in several tools.

**AQUA DESIGNER 6.x** concludes new tools for sludge digestion and carbon dosage. Basic data has been adapted to the actual standard ATV-DVWK-A 198.

**AQUA DESIGNER 6.3** has been extended by further processes for sludge treatment and now provides the complete range of sludge treatment processes. The separate aerobic sludge treatment processes has been added. In the operational costs you can compare different processes by the operational costs and the energy recuperation. By the tool **vertical flown sedimentation chamber** sedimentation chambers can be exactly adapted to the water level and diameter you want. The calculation is grafical supported.

The Carrouselbecken for bigger plants has been added because of requests of clients.

New types of aerators are available at the aeration tool.

Furthermore several improvals and hints of clients has been implemented.

#### **AUQA DESIGNER 7.x:**

Actualization of the dimensioning of smaller plants with simultaneous aerobic sludge stabilization, from ATV A 126 to DWA A 226.

Extension of the aeration tool according to DWA M 229-1 with more load

verifications and more detailed evaluation.

Some corrections especially for separate stage denitrification.

Improvals, extensions, corrections for SBR calculation according to M 210.

Corrections concerning the „-Notation. Sometimes Numbers has been converted inaccurate. So sometimes a software crash occurred.

The copy protection has been changed from hardware dongle to software key. This is also available as network license.

### **AQUA DESIGNER 8.3:**

Since May 2016, there is a new standard valid for design of activated sludge plants. This standard **DWA-A 131** is implemented in this version. Base of the new standard is no longer the BOD, but the COD.

Adjustment SBR to DWA-A 131 from May 2016.

Adjustment of aeration to DWA-M 229-1 from September 2017.

The latest version contains new functions such as a machine and measuring point list and an automatically generated flow diagram.

We have also started to integrate international design guidelines.

## **3.2 AQUA DESIGNER 9.x**

Membrane Reactor Plants can now be dimensioned according to DWA-A 227. Important process steps as cross-flow aeration and permeate pumps are implemented. Thus, the influence of cross-flow aeration on the overall aeration is also taken into account and you can compare the energy consumption of a conventional aeration plant or SBR plant with that of a membrane aeration plant. The other design approaches, such as the MSIG approach, can also be used for MBR design.

Print- and drawing tools has been changed. Now there are extended functions are available. This applies to all prints, drawings and flow diagrams.

With **AQUA DESIGNER 9.2** we have made the operation of the databases clearer. The data are now displayed in a list and can thus be selected more easily.

In the aeration form, aerators with product properties can be selected from databases.

## **3.3 Conventions**

Elements and functions of the program are divided in groups. Depending on their function they are presented differently in the text. The valid conventions are listed below:

<b>Bold</b>	Names for user elements (Keys, Option fields, Control boxes, Menu commands, etc.)
-------------	---

	Names for input and output windows names for the Main menu. Name of forms
grey background	examples, technical information

### 3.4 System Requirements

AQUA DESIGNER requires a , that is compatible with Windows 7,8 or Windows 10.

AQUA DESIGNER is a software working with a graphic user interface using windows features. This is why Windows must be installed on your computer prior to running AQUA DESIGNER.

### 3.5 Scope of Delivery

AQUA DESIGNER is available at our Download-Side [www.bitcontrol.info](http://www.bitcontrol.info) > **download**.

After installing AQUA DESIGNER a code is available. This code should be send to [software@bitcontrol.info](mailto:software@bitcontrol.info). You will receive your license code for AQUA DESIGNER then by mail.

Also the Manual is available for download at the above mentioned adress.

### 3.6 Software Installation

Is one of the above versions of Windows installed? If so, then you can begin to install AQUA DESIGNER and the supplementary data files.

A special installation program that guides you through the installation process is included in the installation package.

If you received a demo version, the installation will be finished.

### 3.7 Starting AQUA DESIGNER

You can start AQUA DESIGNER in two different ways.

## From the Start Menue

Click on **Start > Programs > BITControl > AQUA DESIGNER**.

## Using Explorer

You can launch AQUA DESIGNER from the Explorer by double clicking on the file **AD63.exe** present in the application directory.

## Licensing

After installing AQUA DESIGNER, by the first start you will see a license window. There are two numbers displayed, a Site code and a MID.

Send these codes to [software@bitcontrol.info](mailto:software@bitcontrol.info).

You will receive the activation code. After entering this number, your version is unlocked.

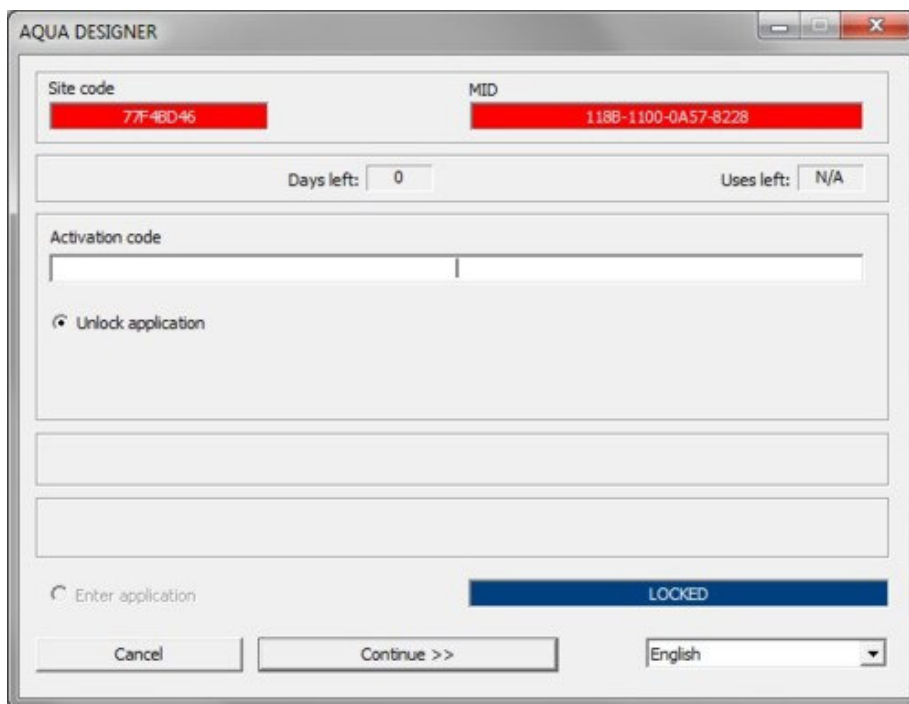

Fig. 1: Activation Dialog (Site code und MID)

## 4 Handling

The Windows-Interface offers the possibility of working with either the mouse or the keyboard. The conventions for using the keyboard have been widely incorporated into AQUA DESIGNER.

### 4.1 Menu Bar

Path name and file name of the current file are on the **Title Bar**.

On the **Menu Bar**, only the file menu is active until completion of the computation. However, the language menu is an exception: You can switch at any time between English and German.

In the **Main Window** frame the project name is displayed. For the case **File > New**, no name initially appears as the project name.

The **Menu Bar** contains almost all the required commands for operating AQUA DESIGNER.

Clicking on a menu, for example **File**, opens a menu window containing different commands. To operate one of the displayed commands simply click on it with the mouse.

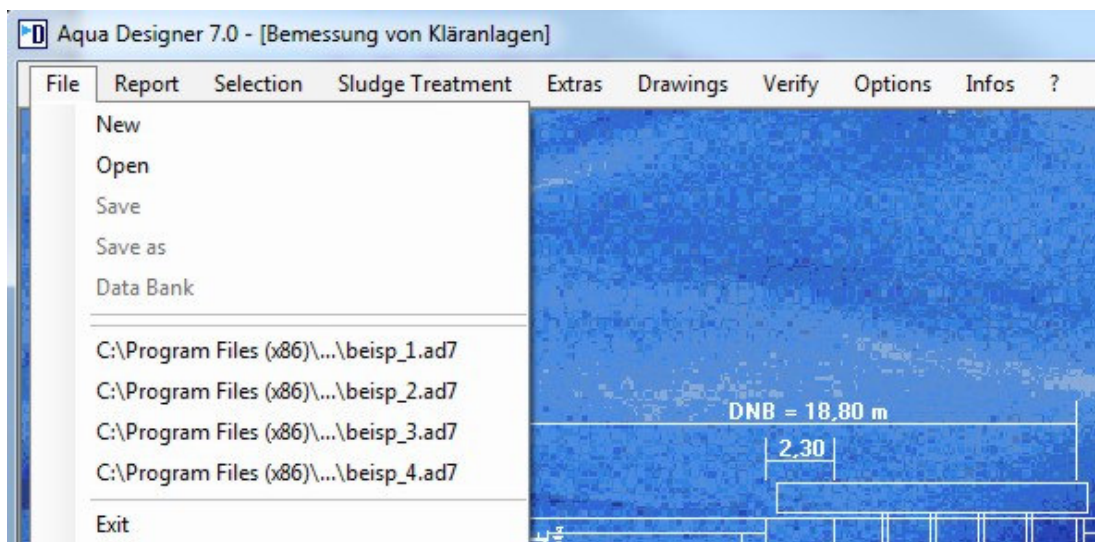

Fig. 2: Menu File

The following table gives you an overview of the functions of the menu bar.

Menu	Menu Commands	Description
File	New	To start a new project
	Open	To open an existing project
	Save	To save a project

Menu	Menu Commands	Description
	Save as	To save a project under a new title
	Data Bank	To save a project data in an access data base
	List of recently opened files	Starting the programme for the very first time you must open the data through File-Open. After that you can open the recently used files directly from the list.
	Exit	To quit the programme. Eventually you will be asked, if you want to save the actual project.
<b>Report</b>	Description	A description of the chosen methods and chosen machines. The description of every chosen vitalization method can be shown separately.
	Dimensioning	Accounting verification of the performed calculation, separate for each calculated method.
	Calculation Grit Chamber	Accounting verification of the sand trap calculation
	Short Documentation	A summary of the most important calculated values on one page.
	Results per Step	Accounting verification of single modules
	Machine List	A list of machines and measuring points is available in Excel to match the calculation process and the selected components.
<b>Selection</b>	A 131, SBR ...	A form to choose a vitalizing method
	Grit and Grease Chamber	A form to choose a sand and fat collecting method.
<b>Sludge Treatment</b>	Thikener	
	Seperate aerobic Sludge Stabilisation	
	Amerobic Sludge Digestion	anaerobic sludge degistion wth gas production
	Sludge Tank	
<b>Extras</b>	Components	A choice of additional modules, which have an influence on the operating costs and the expositional report.
	Operating Costs	Calculation of electricity, sludge disposal, rotting means and staff costs, separate for each method
	Sludge Removal	Sludge balance for clearance basin down steam and return sludge flow suction system.
	Pipelines	Several important diameters of water,

Menu	Menu Commands	Description
		sludge and aeration pipelines.
	Oxygen Efficiency	Economic efficiency of the aeration system in kgO <sub>2</sub> /kWh.
	Buffer Tank	Calculation of the required volume of a buffer tank at <b>SBR</b> -constructions.
<b>Drawings</b>	Drawings	To go directly to the true scaled drawing function
	View Drawing	To print or export (dxf) the drawing
	Mass Calculation	To open the form for the mass calculation with the drawing of the pit
	Bouancy	To open the form for the bouancy
	Flow Sheet	Creation of a flow diagram based on the calculation process and component selection
<b>Verify</b>	Secondary Settling Tank	Recalculation of existing basin, determination of a permitted hydraulic feed
<b>Options</b>	Language	Choice of the operating and print out language
	Settings	Various settings for the calculation process, the complexity of the calculation, the scale and kind of prints outs.
	Process	Setting of the denitrification method, the aeration technique and several other variants.
	General Constants	Parameters for various formulas, margin conditions and dimensions of constructions.
	Constants COD	Parameters for formulas of the dimensioning based on CSB
	Constants Hochschulgruppe	As mentioned above, constants for the commitment of the university group.
<b>Info ?</b>	About AQUA DESIGNER	Version, licence
	About BITControl	
	?	Appeal to the off-line help, as F1

## 4.2 Main Form

The Main Window is the central form of AQUA DESIGNER. Here, different computations and variations of processes of AQUA DESIGNER are visualised. In the **Main Window** the user is conducted through the dimensioning aided by fields with different background colouring, representing the different stages of the computations.



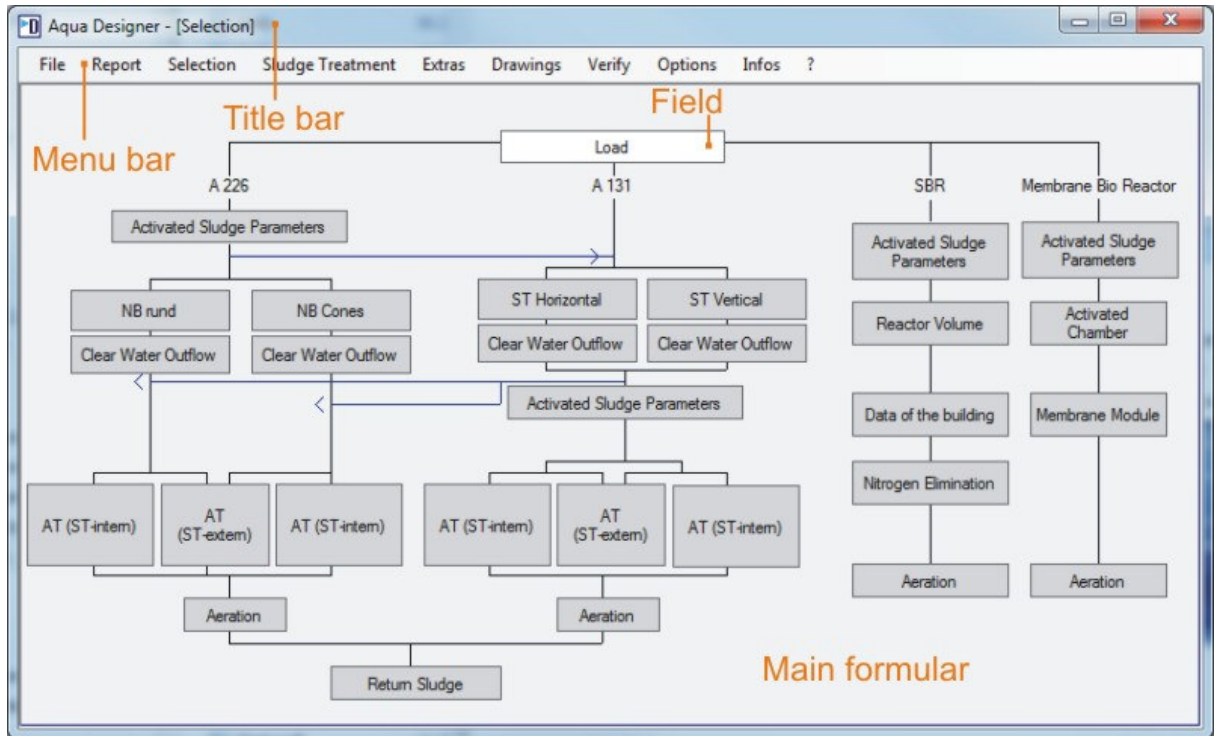

Fig. 3: main window

### Advantages of the Main Form

- Access to completed computations and dimensioning results is possible at any time
- Corrections can begin on any level of the tree diagram
- Variations can be calculated in parallel and can also be compared
- Variations of methods presented as flow diagrams in the Main Window
- Conduction through the AQUA DESIGNER steps with coloured fields
- Display of the most current computation status and options

Main form fields, in principal, are links to the different forms for input and computation.

Different background colouring represent the different stages of the design work and computation. So the different choices in the most current computation are marked by white backgrounds. For example, opening the **Main Window** with **File > New** only the field **Load** has a white background.

The field is marked green after completion of the respective computation. Unavailable fields are marked grey.

The dimensioning of the biological treatment step is completed when one passage of the diagram beginning from **Load** and ending at **Return Sludge** has been completely calculated and is, thus, marked green all the way through.

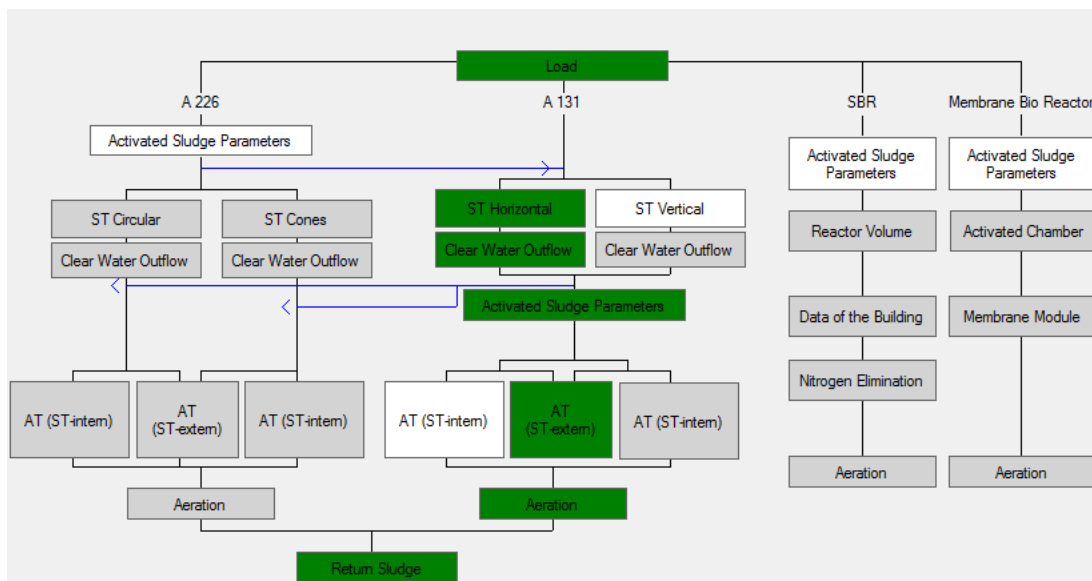

Fig. 4: Main Window with completed calculation

### Remark

When an already calculated form is accessed for changes, the ensuing computations have to be conducted again. This is necessary to ensure the consistency of the completed calculations for all possible variations.

Changes are aborted by leaving the window with Abort. The previous computation is then saved. Thus, you can review or vary each and every step of the computation at any time without repeating the remaining calculation.

## 4.3 Fields and Boxes

### Input Fields

Move the mouse pointer into an input field and double click on the field to mark the displayed value. An input entered via the keyboard overrides the displayed value.

Leave the input field using the mouse or the keyboard. The last value typed in is then accepted.

### Example

The form Basic Data includes an Input field **Sludge volume index**. Move the mouse pointer into the white input field and double click. The value 100 or a value typed in before is marked in blue. Type a number of your choice with the keyboard overwriting the marked value.

### Option Fields

Among different forms, you have the choice of selecting various options. In contrast

to the control boxes you have to decide on selecting one option only. Upon opening a form, one option is always marked.

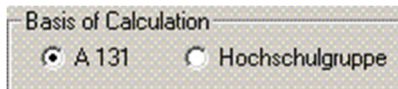

Fig. 5: Option Fields

### Example

In the form **A 226 Basic Data** options for the organic load are shown. The option low is selected when the form is first opened. Clicking on the option high or high and varying, the program automatically calculates using the latest selected choice and the resulting effects.

## Control Boxes

Clarifying processes or construction groups can be selected as additive modules. Marking the respective control box includes the selected module in the design.

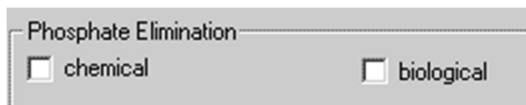

Fig. 6: Control Box

### Example

In Form **A 226 Basic data** the control boxes for **Denitrification** and **Phosphate Removal** are included. Upon opening it for the first time, neither of the two boxes are checked. By clicking on them you mark and select denitrification and/or phosphate removal.

## 4.4 Keyboard Functions

The operation elements can be called through the keyboard.

A few keyboard functions are listed below. All are in accordance with Windows standard.

### Function key

F10                      The first menu on the menu bar is activated

### Keyboard combinations

Ctrl + Esc              Switches to another active Windows application

Alt + Tab	Returns to the previously used application program
Alt + Print Screen	Copies image of the active Window to the clipboard
Print Screen	Copies the entire screen to the clipboard
Alt + Space bar	Opens system menu
Alt + F4	Ends program
Alt	The first menu in the menu bar is activated (in this case file)

As you can see from the list of keyboard functions, it is possible to simultaneously open other windows applications apart from AQUA DESIGNER. Thus, you can work in a word processing program or spreadsheet program at the same time. This can be very useful when you want to compare and check calculations performed in other programs with dimensioning in AQUA DESIGNER.

## 5 First Steps

On our homepage [www.bitcontrol.info](http://www.bitcontrol.info) you will find introductory films on various topics. Here you will also find instructions for your first steps in AQUA DESIGNER.

### 5.1 Demo Mode

If a Demo Version is installed, the functions are limited. After starting AQUA DESIGNER a Demo Form occurs.



Fig. 7: Start Form

Here you are requested to choose your language.

After clicking on OK the Start-Windows of AQUA DESIGNER opens.

A new project will be started by **File > New**.

Please note, that in the Demo Mode its only possible to test AQUA DESIGNER with 5555 or 55555 inhabitants. That's the limitation of the Demo Version.

### 5.2 Introduction

Using two examples presented below, you will be able to learn about the procedures involved in calculating the biological treatment step of a wastewater plant. Following

this, you will assemble a plant design consisting of a detailed report, technical wastewater plant calculations and maintenance cost estimates.

After saving the project in a file, you will calculate the masses of concrete, steel and earth. With the chosen masses, you will evaluate the critical buoyancy factor of the pond(s). Finally, you will save the entire project.

In the following example you will conduct a calculation in accordance with the DWA A 131 /39/ guideline. Here possible clarifying processes and other additional functions are considered.

Viewing and directly working on a completed project is possible by loading and using one of the file examples from the Aqua\_dir directory of AQUA DESIGNER. With **File > Open** you can load these files and continue the project with tasks like drawings or mass calculation.

### 5.3 Calculation based on DWA-A 131

To create or develop a new project, choose **File > New on the menu bar**.

The **Main Window** - the central operations interface - for the dimensioning appears. In this Main Window you will be guided through the calculations by coloured option fields.

Available options for all current calculation phases are distinguished by white backgrounds. If a calculation is actually performed, then the white background changes to a green background.

Unavailable fields have a grey background.

The control box **Load** has a white background at the beginning of the dimensioning process.

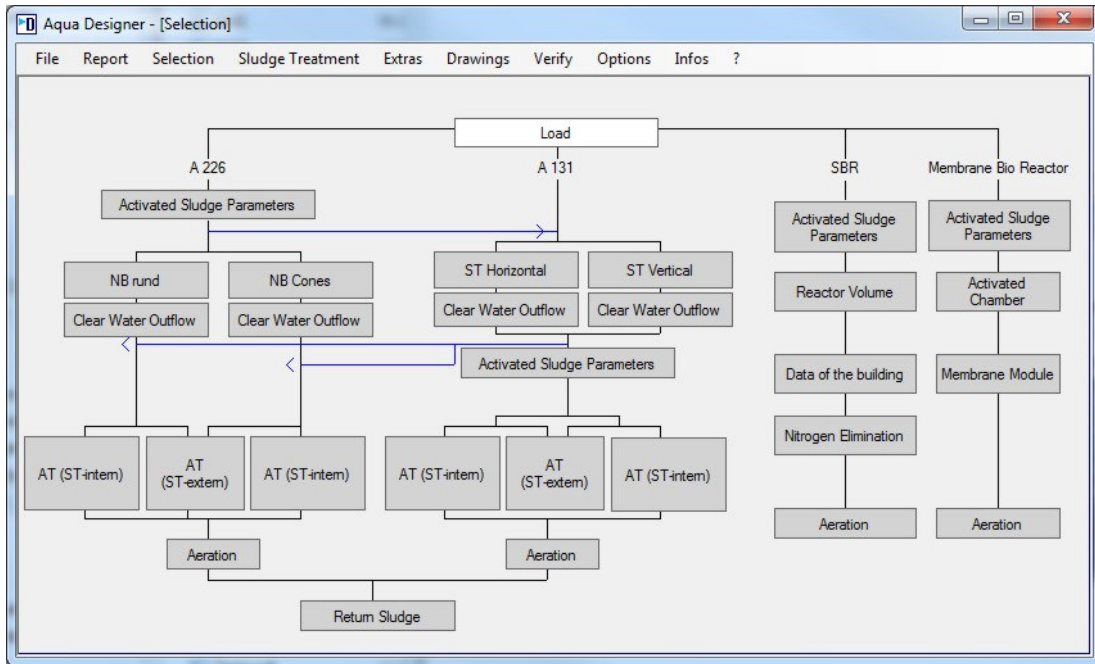

Fig. 8: First available step “Load” in the main form

### 5.3.1 Waste Water Load

Click on the field **Load**. Here you will input the basic data for the wastewater plant load.

	municipal	Supernatant	Industrial Wastewater	
BOD5-Load, total	3000,00	0,00	0,00	3000,00 kg/d
COD-Load, total	6000,00	0,00	0,00	6000,00 kg/d
SS-Load, total	3500,00	0,00	0,00	3500,00 kg/d
TKN-Load, total	550,00	0,00	0,00	550,00 kg/d
P-Load, total	90,00	0,00	0,00	90,00 kg/d
NO3-N-Load, total	0,00	0,00	0,00	0,00 kg/d
Dry Weather Flow				568,19 m3/h
Combined Inflow				568,19 m3/h

Fig. 9: Form for input of loads and water volumes

Move the mouse pointer to the field marked **Project** and enter a project name.

With the mouse or tab key you can shift to the input field **Population Equivalent**. Enter 50000.

After leaving the field for **Population Equivalent** the value 125 l/(Pxd) appears in the field **Spec. Municipal Wastewater Flow**. This is an ATV recommended value. Also an hour index of 14,27 recommended by the ATV-DVWK A118 will be suggested.

Now use the mouse and go directly to **Calculate**. Next to the input field a window titled **Raw Wastewater** appears. In this window Daily Charges (Loads) and Wastewater Volumes are displayed.

Clicking **OK** will take you out of the form **Load** and will take you back to the **Main Form**.

In the Main Form the field for **Basic Data** based on the A131 guideline has a white background.

According to the DWA one can calculate in A 226 /58/ or A 131 /39/ choosing a population equivalent  $\leq 5.000$  inhabitants. As we had chosen 50,000 inhabitants, the A 226 is not available for this example. With the new guideline A131 its also permitted to design small plants. So the A 226 in practice is no longer in use.

### 5.3.2 Secondary Sedimentation Tank

In the **Main Window** choose the field **ST horizontal** (horizontal flow sedimentation tank) in the left part for A131.

This opens the form **A 131 Secondary Settling Tank** for horizontal flow.



A131 Secondary Settling Tank

<b>Basic Data</b> Combined Inflow (Qm) 1466,15 m <sup>3</sup> /h qSVmax (horizontally flowed through) 500 l/(m <sup>2</sup> h) Sludge Volume Index 100 ml/g Return Sludge Ratio 0,75 Thickening Time 2,00 h Dry Solid(Return Sludge)/Dry Solid(Tank Bottom) 0,70 Calculate		<b>Height Zones:</b> Clear Water Zone 0,50 m Dividing Zone 1,86 m Storage Zone 0,79 m Thickening Zone 1,39 m	
Max. MLSS of the Activated Sludge 3,78 kg/m <sup>3</sup> Maximum Surface Flow Rate (qSV max) 1,32 m/h Minimum Surface 1108,34 m <sup>2</sup>		<b>To the inflow building supplied power PE</b> Velocity in the inflow pipe vE 1,00 m/s Diameter of the Inflow Pipe 952,60 mm Activated sludge density 1001 kg/m <sup>3</sup> Ambient fluid density 1000 kg/m <sup>3</sup> Applied power PE 356,71 Nm/s	
<input checked="" type="radio"/> Round Tank <input type="radio"/> Rectangular Tank			
<b>Round Tank</b> Minimum Diameter 38,08 m Diameter of Inflow building, minimum 6,26 m Chosen Diameter 38,10 m Diameter of Inflow building, chosen 6,26 m Calculate		<b>Flocculation in the inlet chamber</b> Top level of thickening zone 3,21 m Inflow Depth, chosen 3,21 m Volume of the Central Building 98,87 m <sup>3</sup> dynamic viscosity n 0,001 Ns/m <sup>2</sup> G-Value (40 - 80 1/s) 52,68 1/s	
Surface without Central Building 1109,31 m <sup>2</sup> Minimum total Height (2/3 FD) 4,53 m Chosen total Height (2/3 FD) 4,60 m Calculate		<b>Inlet opening</b> Height of the inlet gap 500 mm Perimeter of the central construction 19,67 m Surface encircling inflow opening 9,83 m <sup>2</sup> Inflow velocity u (5 -7 cm/s) 7,25 cm/s densimetric Froude number FD (ca. 1) 1,03	
qSV calculated from Surface 500 l/(m <sup>2</sup> h)		<b>Return Sludge Flow</b> Difference inlet to funnel tip 2,09 m Return sludge flow rate at RS=1 1,466,15 m <sup>3</sup> /h Flow rate under MB 0,74 cm/s	
<input type="checkbox"/> Partly vertical Flowed Chamber Inflow Depth / Flow Distance max qSV (Inflow Depth / Flow Distance) l/(m <sup>2</sup> h)			
Control Picture		OK    Cancel	

Fig. 10: A 131 Secondary Settling Tank

In the left part you see the sludge properties. Here you can adapt the design to the sludge conditions of your project. The resulting diameter is 29.86 m. In practice tanks are built in steps of half a meter. So for practical demands its recommended to chose 30 meters as diameter.

Also in this example we reduced the diameter of the inflow building from 4.91 to 4.00 meters. We accept the displayed water level of 4.50 meters.

The secondary sedimentation tank is hereby calculated.

Now you can press the button **Control picture** to get a true scaled drawing of the sedimentation tank. By clicking **OK** you will come back to the form of the secondary sedimentation.

Leave the form **ST horizontal A131** by clicking on **OK** with the mouse.

### 5.3.3 Clarified Water Outlet

In the form **Clear Water Outflow** choose the option **One sided overflow**.

The limit for the hydraulic load of the one sided overflow weir is  $10 \text{ m}^3/(\text{m} \times \text{h})$ . Here with 9.89, the value is close to the limit. Click on **Two sided overflow**. You will get more distance to the limit of  $6.00 \text{ m}^3/(\text{m} \times \text{h})$ .

Parameter	Value	Unit
Length of the Weir (per Weir)	71,63	m
Maximum Weir Overflow Rate (per Side)	6,00	m <sup>3</sup> /(m*h)
Number of Weirs	1	
Minimum Length of the Weir	47,35	m
Total Length of the Weir	71,63	m
Weir Overflow Rate	3,97	m <sup>3</sup> /(m*h)
	1,10	l/(m*s)

Fig. 11: Clear Water Weir with Two-sided Overflow

For smaller plants usually a one sided overflow is sufficient. For larger plants you have to change to two sided overflow.

### 5.3.4 Basic Data

Select **Activated Sludge Parameters** for the calculation based on the ATV A131 guideline. Click on it with the mouse or move to it using the arrow keys on the keyboard.

The form **A 131 Basic data** appears.

**A 131 Activated Sludge Parameters**

Basis of Calculation  
 A 131  Sludge Stabilization

Outflow Requirements  
 Denitrification

Organic Load  
 Max. MLSS of the Activated Sludge 3,78 kg/m<sup>3</sup>  
 MLSS (Aeration Tank) (< 5 kg/m<sup>3</sup>) 3,78 kg/m<sup>3</sup>  
 Sludge Age  $t_{srg}$  25,0 d

Acid Capacity in the Inflow 8,00 mmol/l  
 NTK in the Inflow 58,67 mg/l  
 Ammonia-N in the Outflow 0,00 mg/l  
 Nitrate-N in the Outflow 6,00 mg/l

Phosphate Elimination  
 chemical  biological  
 Factor XP, BM 0,005

External Carbon Dosage  
 External Carbon Dosage  
 Primärschlamm

Density 1200 kg/m<sup>3</sup>  
 COD-Concentration 96,000 kg/m<sup>3</sup>  
 Denitrification Capacity 0,15 kgN/kgCSB  
 Denitrification Rate 3,0 g/(kg<sup>3</sup>h)  
 Additional ES-Production 0,50 kg/kgCSB  
 Max. Denitrification Relation 0,60

Phosphate Elimination  
 XP, BM 3,20 mg/l  
 Biological removed 0,00 mg/l  
 Chemical Removed 0,00 mg/l  
 P-total in the Outflow 6,40 mg/l  
 Anaerobic Volume 0,00 m<sup>3</sup>

Denitrification process  
 Cascade  
 Separate Stage  Simultaneous  
 intermittend  combined

Parameter  
 Inert part of particulate COD fA 0,25  
 Proportion of inorganic matter of filterable fB 0,25  
 Part of easily degradable COD fCOD 0,25  
 Yield coefficient Y 0,67  
 Decomposition Coefficient b 0,17

Process factor PF  

RN	1,4	1,6	1,8	2,0	2,2	2,4
SNH <sub>4</sub> , Control	5 mg/l	<input checked="" type="checkbox"/> 1,50	<input type="checkbox"/> 1,60	<input type="checkbox"/> 1,90	<input type="checkbox"/> 2,20	<input type="checkbox"/> 2,50
10 mg/l	<input type="checkbox"/> 1,50	<input type="checkbox"/> 1,50	<input type="checkbox"/> 1,50	<input type="checkbox"/> 1,60	<input type="checkbox"/> 1,90	<input type="checkbox"/> 2,10

 Process factor PF 1,60  
 Process factor chosen PF 1,60

Fractions COD  

Particulate COD	XCOD,ZB	448,00 mg/l
Dissolved COD	SCOD,ZB	192,00 mg/l
Dissolved inert COD	SCOD,inert,ZB	32,00 mg/l
Particulate inert COD	XCOD,inert,ZB	112,00 mg/l
degradable COD	CCOD,abb,ZB	496,00 mg/l
easily degradable COD	CCOD,la,ZB	124,00 mg/l
filterable inorganic COD	Xanorg,TS,ZB	93,33 mg/l

Result  
 Required Volume VBBmin 16.998,49 m<sup>3</sup>  
 Sludge Age, total 25,00 d  
 Denitrification Ratio 0,420  
 Spec. Surplus Sludge Production 0,428 kg/kg

Result Phosphate Elimination  
 Waste Sludge Production 0,00 kg/d  
 Part of SS-Biological 0,00 kg/m<sup>3</sup>  
 Precipitant Consumption for 0,00 l/d

x = OVC,D / SNO<sub>3</sub>,D / 2,86 1,00

Calculate Interim Result OK Cancel

Fig. 12: Basic data in accordance to the ATV A131

The MLSS, mixed liquor suspended solids concentration, is a result of the calculated sedimentation chamber. So its not recommended to take a higher value for this item.

At the top of the form you see, that we are calculating for simultaneous aerobic sludge stabilization in this example. So the biological part will be calculated based on a chosen sludge age of 25 days. This is the recommended minimum sludge age to get a stabilized surplus sludge.

For phosphate elimination a simultaneous dosage of iron salt is chosen.

The denitrification process is preselected here in the frame at top right. The standard setting is "intermittend".

Accept the suggested data in the form and click on **Calculate**. The result of the calculation then appears.

Leave the form **A 131 Basic Data** by clicking **OK**.

In the Main Window the calculated fields have a green background, indicating that the calculations corresponding to the input values have been carried out.

The available calculations for the next levels in the **Main Window** have a white

background. Since a horizontal flow secondary sedimentation tank based on the ATV A131 guideline has been chosen, now its possible to take a combined chamber systems or separate chambers.

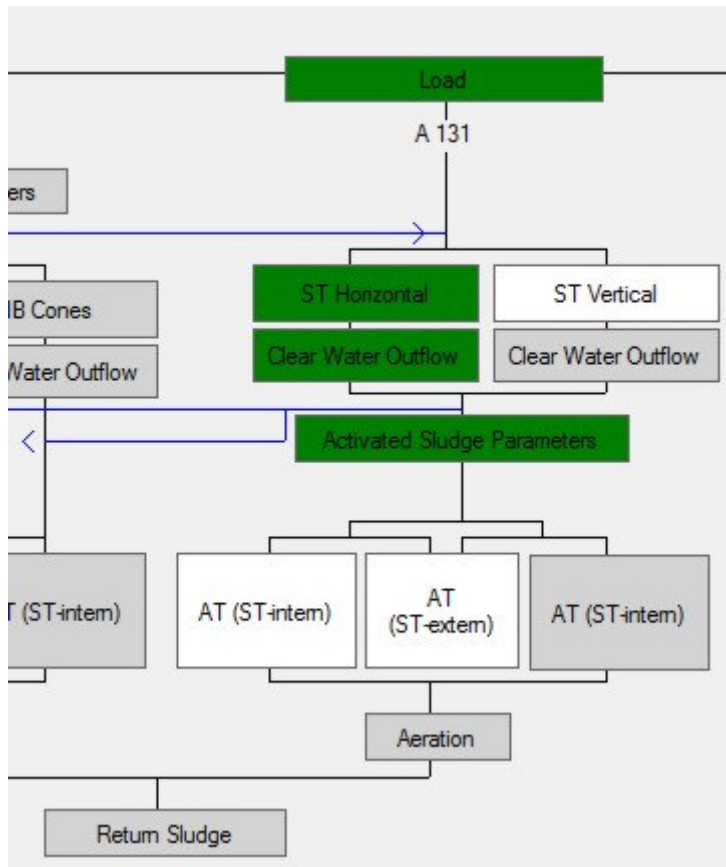

Fig. 13: Main window with calculated steps

### 5.3.5 Multiple Lines

In this example we will take two separate activated chambers. To take more than one line, we have to activate the multiple line property. In the **menu bar** under **Options > Settings**, in the register **Options**, you can activate the multiline property.

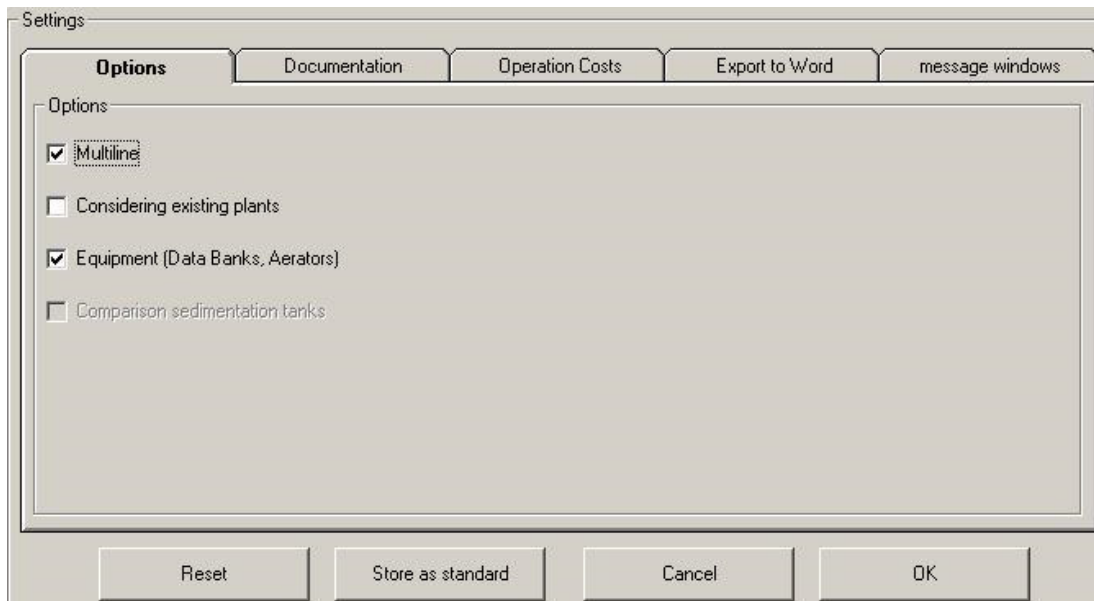

Fig. 14: Activating the multiple line property with Options > Settings

### 5.3.6 Activated Sludge Tank

Select the field **AT (ST extern)**.

**ST extern** signifies that the secondary sedimentation tank is a separate chamber.

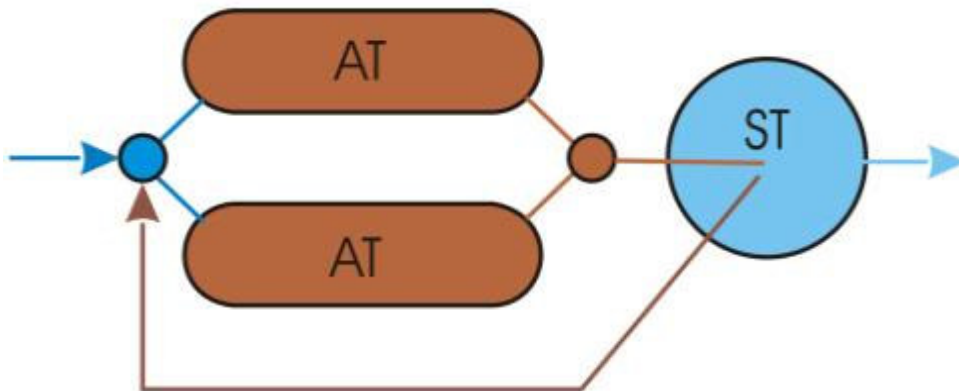

Fig. 15: Activated sludge tank and secondary sedimentation tank as divided chamber system

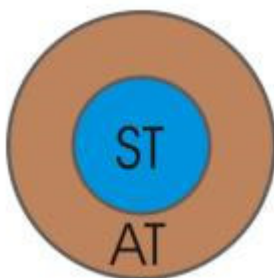

Fig. 16: Activated sludge tank and secondary sedimentation tank as combined chamber system

The form **A131 Activated Sludge Tank** opens.

You can test different tank proportions by inputting various water levels.

Choose a depth of **5 m** and click on the field Calculate. In three steps you get the dimensions of an oxidation ditch. Take 22 for the width and 101 for the length.

Click on **Control Graph**. A scaled drawing of the selected tank is then displayed.

Leave the window by clicking on **OK**.

### 5.3.7 Aeration

Choose the field **Aeration**. A window **Oxygen Transfer** appears. Due to the selected calculation path, combined aeration and mixing is preselected.

Sauerstofflast kgO <sub>2</sub> /kgBSB <sub>5</sub>	2,50
Laufzeit der Gebläse h/d	15,6
Sauerstoffzufuhrfaktor	0,65

Luftmenge, erforderlich	7396,0	m <sup>3</sup> /d
Stündlich erforderliche Luftmenge	474,1	m <sup>3</sup> /h
Gebläsegegendruck, erforderlich	670	mbar

Fig. 17: Oxygen Transfer

Accept the preselected values and click on **Calculate**.

The result of the calculation is displayed.

An additional window Blowers will automatically open to allow you to select compressors for providing compressed air.

A number of 4 blowers, as 2 blowers for each activated chamber is pre selected.

Click on the button **Data Bank**. This opens the window **Blower Data Bank**. The best matching blower from the databank will be suggested. For further informations about the selection criteria see chapter 8 Data Bank .

Aqua Designer - [Gebläseauswahl]

Geforderte Werte  
Gegendruck (mbar) 670    Förderung (m³/h) 65,8

Hersteller	Baureihe	Fabrikat	Gegendruck (mbar)	Förderung (m³/h)	Nennleistung (kW)	Leistungsaufnahme (kW)	Strom (A)	Spannung (V)	Motorwirkungsgrad (%)	Cost	↑
Aerzen	Delta Blower G5	GM 30 L	650	1400	37	26	0	0	93	0	B
Aerzen	Delta Blower G5	GM 30 L	650	1500	37	27,5	0	0	93	0	B
Aerzen	Delta Blower G5	GM 80 L	650	1800	55	44	0	0	94	0	B
Rietschle	DLT	6	700	5,7	0,3	0,3	0	0	68	0	B
Rietschle	DLT	10	700	8,3	0,45	0,45	0	0	72	0	B
Rietschle	DLT	25	700	22	1,1	1,1	0	0	77	0	B
Rietschle	DLT	40	700	37,8	1,85	1,85	0	0	80	0	B
Becker	KDT	3 60	700	47	2,2	1,6	0	0	81	0	B
Becker	KDT	3 60	700	48	2,2	1,7	0	0	81	0	B
Becker	KDT	3 80	700	62	3	2,4	0	0	83	0	B
Rietschle	DTA	80	700	66	3	2,4	0	0	83	0	B
Aerzen	Delta Blower G5	GM 3 S	700	78	4	3,1	0	0	83	0	B
Aerzen	Delta Blower G5	GM 3 S	700	78	4	3,12	0	0	83	0	B
Becker	KDT	3 100	700	90,5	4	3,2	0	0	83	0	B
Aerzen	Delta Blower G5	GM 3 S	700	108	5,5	3,79	0	0	82	0	B
Aerzen	Delta Blower G5	GM 4 S	700	114,6	5,5	4,1	0	0	82	0	B
Aerzen	Delta Blower G5	GM 4 S	700	114,6	5,5	4,12	0	0	82	0	B
Becker	KDT	3 140	700	127	5,5	4,4	0	0	82	0	B
Aerzen	Delta Blower G5	GM 3 S	700	133,8	5,5	4,32	0	0	82	0	B
Aerzen	Delta Blower G5	GM 3 S	700	133,8	5,5	4,36	0	0	82	0	B
Aerzen	Delta Blower G5	GM 3 S	700	142,2	5,5	4,56	0	0	82	0	B
Aerzen	Delta Blower G5	GM 4 S	700	157,2	7,5	5,03	0	0	83	0	B
Aerzen	Delta Blower G5	GM 3 S	700	159	5,5	4,9	0	0	82	0	B
Aerzen	Delta Blower G5	GM 7 L	700	174,6	7,5	6,11	0	0	83	0	B
Aerzen	Delta Blower G5	GM 3 S	700	186	7,5	5,56	0	0	83	0	B

Fig. 18: Selection of Blowers

Aqua Designer Erste Schritte A226.ad8 - [Gebläseauswahl]

Geforderte Werte  
Gegendruck (mbar) 670  
Förderung (m³/h) 237,1

Gebälse-Datenbank 358

Gegendruck (mbar) 700  
Förderung (m³/h) 238,2  
Nennleistung (kW) 11  
Leistungsaufn. (Betr.Pkt) (kW) 7,49  
Motorwirkungsgrad (%) 87  
Bezeichnung GM 7 L  
Richtpreis (Euro) 1

Suchen  
Ändern  
Neu  
Löschen

Übernehmen    Abbrechen

Fig. 19: Data Bank Aeration

Click on **Apply** return to the form **Aeration**.

A window for the selection of mixers appears. Enter a number of **8** mixers. Click on **Data Bank**.

Slow rotation mixers can be identified by the **mixer diameter**. Large diameters are corresponding with slow rotation. After selecting the mixers in the same way, you can design the aeration system.

Click on **Membrane Aerator**.

The standard suggestion for the aeration system is 8 lattices and 1 mixer per group. In this form usually its necessary to edit some values to get a good solution.

Gitter festlegen

Anzahl Gitter

Rührer je Gruppe

Belüfterform wählen

Schlauchbelüfter

Tellerbelüfter

Streifenbelüfter

Gitterform festlegen

Anzahl Querverteiler

Gleichmäßige

abgestufte Aufteilung

Schlauchbelüfter

Beaufschlagung m3/mh

Einzellänge 0,75 m

Durchmesser m

Beaufschlagung, gewählt

m3/mh

Fig. 20: Parameter

**Example:**

Change the following fields:

Mixer 1 Group to 2

Number Lattices to 14

Option: AERATION ONE SIDE

Lattices Distance 1 m

Tubular Aerators Load  $6 \text{ m}^3/(\text{mxh})$

Click the button Equipment and Change the value mixers – distance in front of mixers to 12 m.

Click on **View Drawing** after you have entered the above values. The drawings are displayed and updated. In a second window a single lattice is displayed and to its left detailed technical data of the pictured lattice and the aeration of the according chamber (tank) are listed.



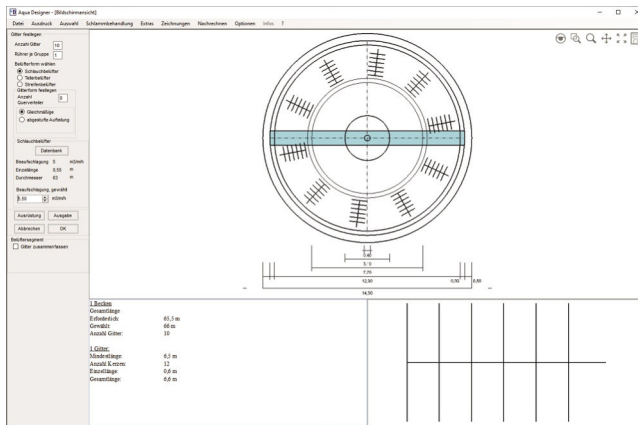

Fig. 21: Membrane Aerator

Leave the Window **Membrane Aeration** with **OK** and select **Return Sludge** in the **Main Window**

### 5.3.8 Sludge Recirculation

In the form **Return Sludge Transport** you have three options for the sludge transport.

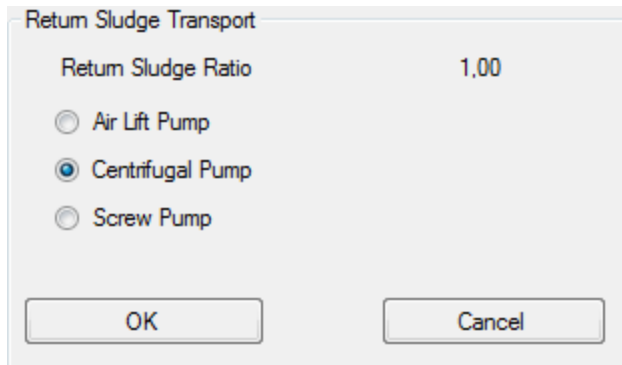

Fig. 22: Return Sludge Transport

Choose **Centrifugal Pump** for the sludge conveyor.

Centrifugal Pump

Suction Remover

Output QRS 568,19 m3/h

Number of Pumps

Transportation Height  m WL

Output 237,00 m3/h

Transportation Height 1,5 m WL

Motor Power 5,5 kW

Fig. 23: Sludge transport with centrifugal pumps

Enter **4** into the input field for **Number of Pumps** and click on **Data Bank**.

Accept the recommended pump.

Leave the form **Return Sludge Transport** with **OK**.

### 5.3.9 Save Data

With this you have completed one calculation using the DWA A 131 /39/. This is visible by a continuous green line leading from **Load** up to **Sludge Tank in the Main Window**.

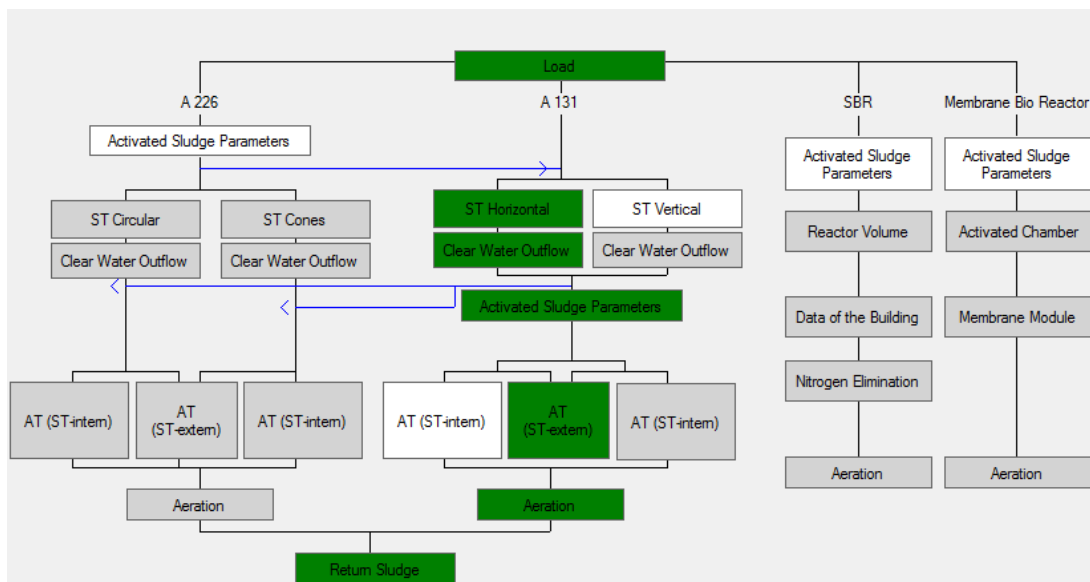

Fig. 24: Main Window with completed calculation

At this stage it is prudent to save the completed calculation to avoid losing data.

In the menu **File** choose the command **Save as**. The Standard-Windows menu appears.

All AQUA DESIGNER data files are identified by the extension .AD9. Keep this extension so that AQUA DESIGNER can automatically recognise the files.

### 5.3.10 Sludge Storage

You will find the sludge tank under **Sludge Treatment > Sludge Tank**.

In the form **Sludge Tank** enter the values as shown in the picture and click on **Calculate**. The required volume of the container is displayed for the selected detention time and thickening.

Mark the control box for **Mixer**. This means that a mixer is selected to optimise the sludge thickening.

It is required to select the control box for **Pump** as well when there is no equipment for sludge removal available.

Sludge Tank

Mixer

Centrifugal Pump

Sludge Storage Time  d

Number of Tanks

Minimum Volume of each Tank 653,60 m<sup>3</sup>

Chosen Diameter  m

Height 16,98 m

Mixer

Number of Mixers (total)

Spec. Energy Input  W/m<sup>3</sup>

Motor Power kW

Fig. 25: Calculation Forms for Sludge Tank

In the window **Mixer** click on the button **Data Bank** and accept the recommended mixer by clicking on **Take**.

Click on **OK** to leave the form.

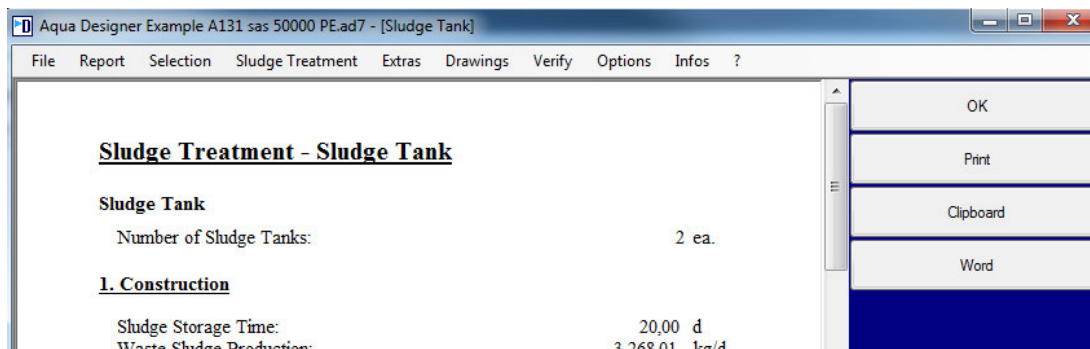

Fig. 26: Documentation of Sludge Tank

The documentation of the sludge tank design will appear. Click **OK** again.

### 5.3.11 Design Assembly

In the menu **Documentation** you can now view the result of the wastewater plant calculations. Furthermore, using different additional functions, you can assemble a final presentation-in quality design **that can be submitted to official authorities for approval**. The output may be viewed on the monitor, or routed to a printer, or imported into a word processing program.

The extras - selection of construction components for the preliminary treatment, evaluation of steel, concrete and earth masses, buoyancy calculations, dimensioning of pipelines - are handled in detail in later chapters of the handbook.

The documentation of the design is constructed in such a manner that it can be presented to any contractor, or submitted to official authorities without any additional changes.

All required documents for proof of the selected concept are included.

Design contents:

- Description
- Waste water plant calculations
- Operating costs

#### Description

In the menu **Documentation** choose the command **Description**. The Title of the description appears.

Click on the button **>>**, to view the description of the individual construction groups.

If the text exceeds the screen height, you can scroll the text vertically using the scroll bar.

## Calculation

In the menu **Documentation** choose the command **Dimensioning**. The Title of the waste water plant calculation appears with the project name and waste water plant size.

In the wastewater plant calculation you will find several additional results:

- Determination of pipeline diameter
- Heat removal from the blower room.

The button **Drawing** will directly take you to the scaled drawing of the biological step. This drawing follows the secondary sedimentation tank in the waste water plant calculation. With the button << you will not return to the previous screen, but to the calculation documentation of the secondary sedimentation tank.

## Operating Costs

Choose **Extras > Operation Costs**.

After depressing the button >> the window **Power Consumption** appears. All energy consuming devices are listed here.

Fig. 27: Basic data for evaluation of energy costs

With **OK** accept the preselected values of the form.

Do the same in the forms **Sludge Removal** and **Staff**.

After depressing the button **OK** in the form **Personnel**, the output of the operating cost result appears on the screen.

BITControl	AQUA DESIGNER 9.2 - Manual	Seite: <b>36</b> von 314
	5 First Steps	Version: <b>92-00</b>

Using the **scroll bar** you can view the entire calculation.

With **OK** return to the **Main Window**.

## 6 Theory

Using AQUA DESIGNER, wastewater plant dimensions are calculated based on the activated sludge process. The occurrence of the breakdown of organic materials, nitrogen and phosphate compounds is investigated.

### 6.1 Activated Sludge System

#### 6.1.1 Constituents

Specific loads in raw sewage (Germany):

BOD <sub>5</sub>	60	g/(E*d)
Ratio COD/BOD <sub>5</sub>	2:1	
COD	120	g/(E*d)
filterable solids	70	g/(E*d)
P total	2,5	g/(E*d)
N total	11	g/(E*d)
undissolved components	30	%
dissolved components	70	%

Key concentrations in raw sewage:

BOD <sub>5</sub>	200 – 300	mg/l
COD	400 – 600	mg/l
P total	5 – 20	mg/l
N total	30 – 80	mg/l

The total nitrogen concentration in raw sewage is predominantly present as Total Kjeldahl Nitrogen (TKN) consisting of the unoxidised organic nitrogen and the ammoniacal nitrogen: Norg + NH<sub>4</sub>-N.

#### 6.1.2 History

Images of the stinking cities of the Middle Ages and the hygienically desolate conditions up to the 19th century are quite familiar. However, we are hardly aware today that advanced civilisations of earlier centuries or millennia had already achieved much more in this respect.

In the 5,000-year-old city of Mohenjo-Daro of the Indus culture in India, remains of a canal system were found.

The Sumerians probably took over their knowledge of hygiene from the Indus

culture. In the early cities of the Sumerians, toilets and baths are found inside the dwellings, drainage pipes made of clay and sewers in paved streets.

The Egyptians also drained their temple and palace complexes as early as 2,600 BC using drainage systems that were covered and lined with copper sheets. The Egyptians were aware of the value of excrement. Urine was even sacred because of its healing properties.

The technical achievements of the Romans are still impressively present to us today. They also achieved a high level in water supply and disposal. Examples of water supply are the water pipes that led from the Eifel to Cologne, for example. In the city of Cologne around 300 AD, each citizen had about 600 litres of water at his disposal. Sewage was mainly drained off through canals. Some public washrooms were equipped with a permanent flushing system. A sewer ran under the Hochstraße in Cologne. An impressive example of Roman canal construction is the Cloaca Maxima in Rome. Construction of this 3.4 m wide canal with a brick vault began in 578 BC. Parts of this structure can still be seen today. A city with 1.3 million inhabitants could hardly have functioned without a high standard of sewage disposal. Tenement buildings that were not connected to a sewer system were disposed of with portable vases that were emptied into the sewer system or collected by commercial waste disposal companies. In non-sewered districts, excrement was collected in pits. The faeces collected in this way were sold as fertiliser by a specialised trade in the surrounding area.

In the turmoil of the migration of peoples, the achievements of antiquity were completely lost in Europe. Not only the Romans fled from the Germanic tribes invading Central Europe, but also part of the established Celtic population fled from the invading barbarians.

The Franks and other Germanic tribes avoided the Roman cities and settled in rural settlements. This was one of the reasons for the break in technology and habits of hygiene and waste disposal. As a result, the cities visibly decayed and with them the urban infrastructure. In the Middle Ages, the knowledge of drainage and hygiene had disappeared so thoroughly that the alleys of the cities resembled cesspools in which people had to make their way through mud, excrement and domestic animals. In the process, one often had to be careful not to have a faecal bucket emptied over one's head.

It is still known of the Sun King Louis IV that he lived in great splendour but lacked a toilet or adequate cleaning facilities.

An awareness of the connection between a multitude of diseases, high mortality and catastrophic hygienic conditions did not develop until the 19th century. Pioneers of this awareness were natural scientists like Robert Koch, who identified the anthrax bacillus, the tuberculosis bacterium and the cholera pathogen. Max von Pettenkofen experienced several cholera epidemics in Munich in the middle of the 19th century. Although he still drew wrong scientific conclusions, he demanded that water and sewage be separated, which was quite correct. He took action against the sick pits that existed in large numbers in Munich, some of which were located directly next to wells. Since the storage of faeces in pits or other systems within the cities had proved to be problematic, drainage systems were built in many cities in the 19th century. In 1775, the water closet had been invented in England. By 1800, a quarter of London's households were equipped with a water closet. This achievement did not find its way to the continent until 1840, via Hamburg. Along with the water closet,



BITControl	AQUA DESIGNER 9.2 - Manual	Seite: 39 von 314
	6 Theory	Version: 92-00

the alluvial sewer system also became established.

The activated sludge process was developed in 1912 by the Chief Chemist Arden and his assistant Lockett, at the wastewater plant in Manchester, England.

Initial experiments for wastewater treatment with precipitation / flocculation and then irrigation and soil filtration provided unsatisfactory results with unacceptable after effects. Better results were achieved by wastewater treatment plants operating with resident micro-organisms.

Lockett was inspired to batch experiments with micro-organisms in suspension from reports of experiments with resident organisms performed in the USA.

Initially, he filled wastewater into a cylinder and aerated the wastewater until nitrification took place. He then allowed the developing sludge flocs to settle and only disposed of the residual water. Repeating this experiment several times resulted in sludge concentration in the cylinder with subsequently shorter time for wastewater clarification.

Based on these experiments and the conclusions Lockett and Arden developed the activated sludge process in a flow-through system.

They presented the activated sludge process on April 3rd, 1914 to the British Society of Chemists in Manchester.

As early as 1916, the first large wastewater plants using the activated sludge process were in operation in England and the USA. /13/

### 6.1.3 Description of Operation

In the activated sludge process the required tank volume is minimised by integrating the return activated sludge or returned biomass in the operational process. Thus, the concentration of biologically active micro-organisms in the tank is not solely dependent on their growth rate. Increase in the micro-organism concentration by using the return activated sludge process, of the settled and collected sludge in the secondary sedimentation step, increases concentration of biomass (micro-organisms) and thus increases metabolic turnover rate.

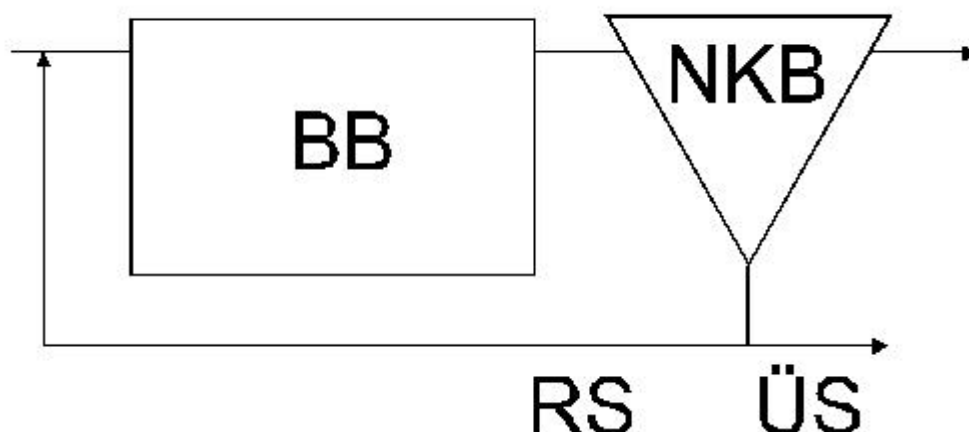

Fig. 28: Activated sludge process (BB = Activated Sludge Tank, NKB = Sec Sedimentation Tank, RS = Sludge Recirculation, ÜS = Excess Sludge)

In the activated sludge pond (BB) mainly organic matter, nitrogen and phosphorus compounds, are transformed and removed from the wastewater by distinct processes.

The simultaneous aerobic sludge stabilisation determines a high sludge age resulting in a good purification rate regarding the BOD<sub>5</sub> and COD (chemical oxygen demand) parameters.

Wastewater plants with simultaneous aerobic sludge stabilisation are dimensioned for large volumes because of a high sludge age. As a result they are insensitive to the commonly occurring variations of wastewater volume and concentration.

This results in high safety and stability of the operational processes.

The produced sludge is stabilised aerobically and does not require further treatment. A mechanical thickening and possibly lime conditioning is necessary for larger wastewater treatment plants.

With the long detention time, nearly complete nitrogen elimination is possible in spite of low nutrient concentration in the activated sludge pond.

## 6.2 Loading and Sludge Age

The composition of the biological association and therefore the type of transforming processes in the activated sludge is dependant on the sludge load.

Die BOD<sub>5</sub> sludge load B<sub>TS</sub> stands for the amount of organic substrate entering the plant and is measured as BOD (biochemical oxygen demand) per kg activated sludge and day.

Load:

$$B_{SS} = \frac{Q \cdot BOD_5}{SS_R \cdot VR \cdot 1000} \left[ \frac{\text{kg}}{\text{kg} \cdot \text{d}} \right]$$

$B_{SS}$	BOD <sub>5</sub> -sludge load	$kg/(kg*d)$
$Q$	Inflow Volume	$m^3/d$
$BOD_5$	Concentration in Activated Chamber (BB) -Influent	$mg/l$
$SS_R$	Mixed liquor suspended solids	$kg/m^3$
$V_R$	Volume of Activated Sludge Tank	$m^3$

The micro-organism growth rate and, thus, the sludge production depend on the amount of substrate or loading. In case of high loading rates, the amount of biomass produced is high and is removed from the system as excess sludge. The excess sludge production ( $\dot{U}_S$ ) relates the sludge age to the loading .

The sludge age results from the ratio of total sludge mass in the system to daily sludge production. It determines how long an activated sludge floc remains in the system. No species with a reproduction time longer than the sludge age can establish itself in the system.

Sludge Age:

$$t_{SS} = \frac{SS_R * V_R}{WS_B} \quad [d]$$

$WS_B$       Excess Sludge Production      [kg/d]

### 6.3 Decomposition of Organic Matter

The organic wastewater components of the influent are predominantly decomposed in the activated sludge pond.

To a large extent, initially insoluble organic substances are adsorbed to cell walls and subsequently transformed into soluble substances by hydrolysis. This makes them available for biodegradation.

The heterotrophic micro-organism in the activated sludge mainly transform the organic compounds into CO<sub>2</sub>, H<sub>2</sub>O and biomass by aerobic and anoxic processes.

Rheinheimer /12/ presents an equation for the aerobic and anoxic metabolism of soluble organic substances.

Aerobic decomposition of organic substances:

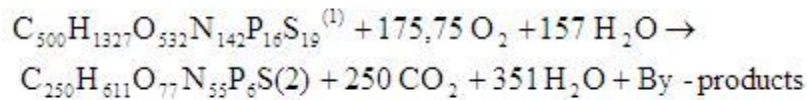

Anoxic decomposition of organic substances:

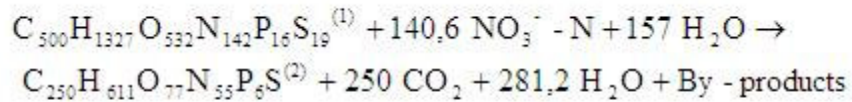

(1) Substrate, (2) Biomass

Fig. 29: Equation for metabolism

The nutrient ratio in the influent is of great importance for biological degradation. The micro-organisms require carbon as well as nitrogen and phosphorus for cell synthesis. If any one of the components is unavailable in sufficient quantity, the metabolism of the micro-organisms is impaired (LIEBIG: Law of the Minimum).

A desirable nutrient ratio is

$$C : N : P = 30 : 2,5 : 1$$

or

$$\mathbf{BOD_5 : N : P = 100 : 5 : 1}$$

For too low phosphorus or nitrogen concentrations in the wastewater composition these substances need to be added. Ammonia salts or urea can be added in case of nitrogen deficiency.

In the community, wastewater nitrogen and phosphorus are usually present in sufficient quantities.

## 6.4 Nitrogen Decomposition

In wastewater, nitrogen is nearly completely present in its reduced form as ammonia.

### Ammonification

Organically bound nitrogen - ex. in Urea - is transformed into soluble ammonium through the process of ammonification.

Ammonification of Urea:

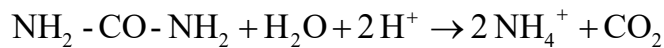

If it goes directly into the receiving water, ammonium oxidises to nitrate in the self-purification process. The oxygen requirements are high for nitrification and, as a result, the oxygen concentration in the surface waters would be considerably reduced. This leads to further oxygen depletion of eutrophic waters. Furthermore, in surface waters, ammonium when twelve times lower in concentration than nitrate has a disturbing influence on biological processes. Therefore, it is useful to go through the nitrification process in the wastewater plant itself.

For every one ammonium molecule that is formed one  $\text{H}^+$ -ion is used. Initially, this has a positive effect on the buffer capacity of the wastewater. The equation for nitrification will show that  $\text{H}^+$ -ions are released and the buffer capacity of the water is again reduced.

### Nitrification

The nitrification process has various negative effects on the condition of natural (surface) waters. Therefore, it is desirable to go through the nitrification process within a controlled technical system.

The autotrophic nitrifying bacteria nitrosomonas and nitrobacter gain energy for their metabolism and cell synthesis from oxidising ammonium.

The oxidation of ammonium takes place in two steps:

#### 1. Nitrosomonas: Nitrite



#### 2. Nitrobacter: Nitrate

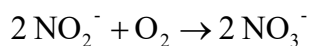

The carbon source for the nitrifying bacteria is inorganic carbon, ex. the dissolved  $\text{CO}_2$ . Dissolved  $\text{CO}_2$  is available from the metabolism of heterotrophic microorganisms and the degradation of organic compounds.

### Denitrification

The nitrogen has been transformed from the reduced form to the oxidised form by nitrification. However, it is still present as nutrient in the wastewater. By denitrification the soluble nitrate and nitrite nitrogen are transformed to elementary nitrogen or, in the worst case, to a slight degree reduced to  $\text{N}_2\text{O}$  (laughing gas, nitrous oxide) and escape as gas.

A large part of the heterotrophic micro-organism is able to satisfy its oxygen demand by reduction of nitrate and nitrite nitrogen when dissolved oxygen is not present. The portion of these organisms in relation to the total existing heterotrophic micro-

organisms present in the system generally is between 70 and 90 %.

The basic equation for the denitrification is as follows:

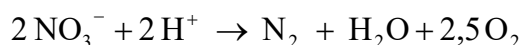

Denitrification is achieved, for example, by aerating and mixing the wastewater alternately and mixing it only after meeting an upper limit for nitrate concentration. The heterotrophic bacteria use the nitrate as energy source during the non aerated phases. The aeration switches on again after a lower limit for the nitrate concentration is reached. This technique is called intermittent denitrification.

Almost complete denitrification is achieved by using a time switch in case of unavailable measuring techniques for automating the denitrification process.

## 6.5 Phosphorus Decomposition

Phosphorus in the wastewater is predominantly present as orthophosphate. The soluble inorganic polyphosphates and organic phosphorus compounds are transformed into orthophosphates in the course of the decomposition processes. This is the only form for cell uptake by the micro-organisms.

### Biological Phosphorus Removal

The natural P-content of the dry cell mass is around 3%. Phosphorus has an important role, for example, in the energy metabolism with the energy carriers ADP/ATP.

Phosphorus is stored as polyphosphate in different cell compartments in the enhanced biological uptake of phosphorus.

An enhancement of phosphorus in the activated sludge is promoted by the alternation of aerobic and anaerobic conditions where P-storing bacteria are particularly well adapted. For this, an anaerobic tank can precede the activated sludge tank. This technique is not included in the current version of the program.

The anaerobic phase can be integrated in the processes of the activated sludge tank especially with the methods of simultaneous aerobic sludge stabilisation and intermittent aeration by prolonging the unaerated phase over the Deni-phase. True anaerobic conditions then exist in the activated sludge tank./10/

### Anaerobic Volume

The anaerobic phase should not be included into the evaluation of the sludge age as there is very reduced biological activity and barely any sludge growth present. Thus an anaerobic volume should be added to the activated sludge volume.

The calculation of the anaerobic volume is based on a publication by the Technical University Darmstadt /17/.

The following qualifying factors encourage biological phosphorus removal.

BITControl	AQUA DESIGNER 9.2 - Manual	Seite: 45 von 314
	6 Theory	Version: 92-00

- decomposed raw sewage, for example, generated from pressure pipes with organic acid concentrations of  $\geq 50$  mg acetic acid/l
- BOD1/BOD5 ratio  $\geq 0.3$  or BOD5-filtrate/BOD5-original  $\geq$  ca. 0.4
- Industrial wastewater with high organic load
- N/BOD5 ratio in the denitrification inflow  $\leq 0.25$
- None or short presedimentation
- mechanical thickening of primary and excess sludge
- low P-load following the sludge treatment
- Separate sewerage system with little extraneous water

The computation is based on the contact time during the anaerobic phase. The dry weather inflow and the return sludge must be taken into account when dimensioning the anaerobic tank.

Boll/17/ recommends an anaerobic contact time of 0.75 – 1.0 hours for the ideal case when most of the above listed conditions apply.

For less ideal conditions, he recommends a contact time of 1.0 – 2.0 hours. This recommendation is also valid for activated sludge systems with simultaneous sludge stabilisation and low loading.

AQUA DESIGNER suggests an anaerobic contact time of 1.0 h on the basis of the recommendations for the biological phosphorus removal with intermittent aeration and the recommendations of Boll.

### Chemical Phosphorus Removal

A limit of 2,0 mg/l for phosphorus concentration during the operational process is not always maintained with biological phosphorus removal. Therefore, it is necessary to provide for a chemical precipitation step. The chemical precipitation is a phase transition process where dissolved phosphate forms an insoluble compound with another dissolved precipitant/flocculant and sediments in the secondary sedimentation tank.

For this process the precipitants  $\text{FeCl}_3$  and  $\text{AlCl}_3$  are available in the program.

## 7 Dimensioning

### 7.1 Introduction

Dimensioning comprises the biological step calculation which consists of aeration, secondary sedimentation and return sludge transport, including machinery and building design.

Furthermore, computation of sludge storage and excess activated sludge transport is also included.

All computations are based on guidelines contained in the DWA Worksheets .

You can access dimensioning with **file > new**.

A previously calculated computation can be loaded by using **file > open**. The standard Windows dialogue appears. Most of the menus are inactive until the dimensioning process is completed.

The commands in the Recalculation and Option menus remain active. Also it is always possible to switch at anytime between German, English, Polish or Hungarian as the working computation language. With **Options > Details** you have access to numerous calculation factors.

### 7.2 Dimensioning Limits

With AQUA DESIGNER you calculate continuous and discontinuous flowed activated sludge systems and membrane activated sludge systems.

The intermittent denitrification method is preselected for nitrogen elimination. This is the most meaningful method for the most problems. Other methods like pre stage denitrification, only C-degradation or only nitrification can be chosen by the Menu.

Oxygen is introduced into the activated sludge pond by membrane aeration or surface aeration. Mixing devices are used when separated mixing and aeration is chosen.

For air supply membrane tube aerators, strips and discs are available. For separated mixing and aeration mixers are provided.

The population equivalent may be chosen between 50 and 5.000.000 population equivalents. The economically viable upper and lower limits must be examined individually.

Continuous and discontinuous-flown activated sludge plants can be computed in parallel. However, this is only possible if the same standard is used as a basis for both methods. If, for example, a continuously system according to A131 with simultaneous aerobic sludge stabilization is designed first, the SBR plant must also be with the A 131 aerobic simultaneous sludge stabilization.

For warm and cold climate zones, the design approaches for aerobic sludge ages and total sludge ages were adapted to the recommendations of /64/ DWA-Themes T4/2016. The design approaches can thus be used in the temperature range of 5 -



30 °C. The design of the sludge layers and the total sludge layers can be adapted to the recommendations of /64/ DWA-Themes T4/2016.

### 7.3 Loading

The values for calculating the inflow sewage loads and water volumes are entered in the form **Load**. Apart from data of the municipal loading, industrial wastewater loads and internal response as turbid water may be incorporated.

Project Name: Example 50000

Spec. Quantities  Absolute Quantities

People Equivalent: 50000

Divisor Daily Peak xQmax: xQmax Standard 14,27 h/d

Spec. Municipal Wastewater Flow: 125,00 l/(P\*d)

Infiltration water amount: 50,00 %

Rainwater Factor fS.QM: 1,00

Spec. BOD5-Charge: 60,00 g/(P\*d)

Spec. COD-Charge: 120,00 g/(P\*d)

Spec. MLSS-Charge: 70,00 g/(P\*d)

Spec. TKN - Charge: 11,00 g/(P\*d)

Spec. P-Charge: 1,80 g/(P\*d)

Spec. NO3-N-Load: 0,00 g/(P\*d)

Pre Sedimentation  Pre Sedimentation

Supernatant  Supernatant

Industrial Wastewater: 800,00 m3/d

Industrial Wastewater:

Hour Index: 8,00 h/d

BOD5-Concentration: 3000,00 mg/l

COD-Concentration: 5000,00 mg/l

SS-Concentration: 1000,00 mg/l

TKN-Concentration: 110,00 mg/l

P-Concentration: 20,00 mg/l

NO3-N-Concentration: 0,00 mg/l

Calculate

Raw Wastewater	municipal	Supernatant	Industrial Wastewater		
BOD5-Load, total	3000,00		2400,00	5400,00	kg/d
COD-Load, total	6000,00		4000,00	10000,00	kg/d
SS-Load, total	3500,00		800,00	4300,00	kg/d
TKN-Load, total	550,00		88,00	638,00	kg/d
P-Load, total	90,00		16,00	106,00	kg/d
NO3-N-Load, total	0,00		0,00	0,00	kg/d
Dry Weather Flow				668,19	m3/h
Combined Inflow				668,19	m3/h

after Primary clarification	municipal	Supernatant	Industrial Wastewater		
BOD5-Load, total	2250		1800	4050,00	kg/d
COD-Load, total	4500		3000	7500,00	kg/d
SS-Load, total	1750		400	2150,00	kg/d
TKN-Load, total	500,5		80,08	580,58	kg/d
P-Load, total	80,1		14,24	94,34	kg/d
NO3-Load, total	0,00		0,00	0,00	kg/d

OK Cancel

Fig. 30: Load - Selecting all Parameters

The basis for the evaluation of load data, will be the DWA-A 198 in April of 2003.

The data determined can be changed individually.

Industrial parts are entered by the user.

Select the check box primary treatment, to get the reduced loads and concentrations depending on the flow time. With these values, the biology is then calculated.

## 7.3.1 Load DWA

### Input Options

The form **Load** enables you to enter inflow data individually and flexibly. It is possible to enter the hydraulic data and constituents as specific or absolute values. They may also be entered as inflow concentrations. From the selected type of values the corresponding values are automatically calculated.

Parameter	Value	Unit
People Equivalents	50000	P
Hour Index	12,000	h/d
Spec. Domestic Waste Water Inflow	173,00	l/(P*d)
Infiltration Water	50,00	%
Faktor Combined Waste Water	1,000	
Spec. BOD5-Charge	60,00	g/(P*d)
Spec. COD-Charge	120,00	g/(E*d)
Spec. MLSS-Charge	70,00	g/(E*d)
Spec. TKN - Charge	11,00	g/(P*d)
Spec. P-Charge	1,80	g/(P*d)
Spec. NO3-N-Charge	0,00	g/(E*d)

Fig. 31: Form on loading, selecting the option for specific values

### Specific Values

The option on specific values is active upon opening a new project and the form Loads. First enter the Population Equivalent before selecting a different option for the load values. This step is required for the automated conversion of values within the different options.

After entering the PE you may change to the option for absolute values. If you do this, please read the part on absolute values of the handbook.

ATV standard values are preselected for municipal wastewater sewage loads and volumes. These values may be changed independently.

Industrial and trade loading are entered by the AQUA DESIGNER user.

### Municipal Loading

The population equivalent in the window **population equivalent** only encounters the municipal wastewater load.

The input is limited to values ranging between 50 and 3 000 000 inhabitants.

## Wastewater Inflow

After entering the number of people equivalents an hourly rate is submitted. This hourly factor refers to the DWA A 198/56 /

The determination of the specific data and wastewater volumes is done mainly on the basis of Chapter 4.2.3, "discharge data on past experience".

### Dry Weather

$$Q_{T,aM} = Q_{S,aM} + Q_{F,aM} \quad l/s$$

$$Q_{S,aM} = \frac{EZ * w_{S,d}}{86400} + AE_{,G} * q_G \quad l/s$$

Daily peak flow during dry weather throughout the year

$$Q_{T,max} = \frac{24 * Q_{S,aM}}{x_{Qmax}} + Q_{F,aM}$$

For the divisor  $x_{Qmax}$  a spreading width is given, covering the area between  $Q_{T,h,max}$  or  $Q_{T,2h,max}$ . Aqua Designer presents the lower value of the specified band, according to  $Q_{T,h,max}$ .

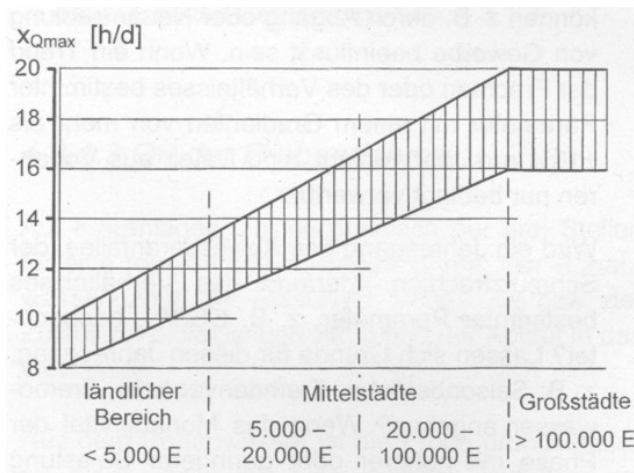

Fig. 32: Divisor  $x_{Qmax}$  depending on the size of the area /56/

The mixed water outflow  $Q_M$  is determined by the factor  $f_{S,QM}$ . This value is interpolated depending on the system size.

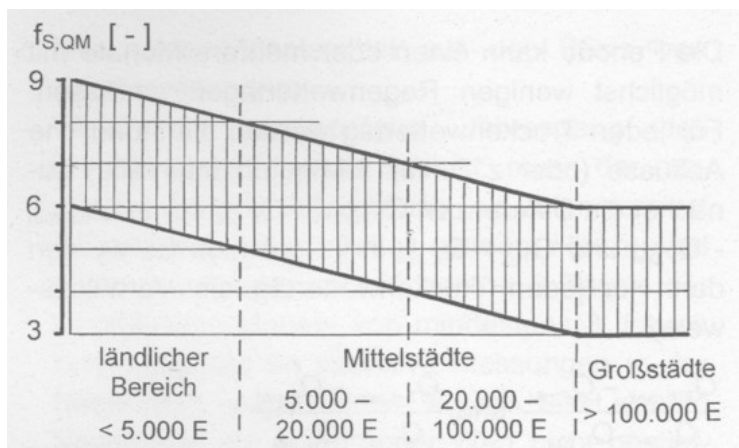

Fig. 33: Area of Factor  $f_{S,QM}$  to determine the optimum mixing water flow to the treatment plant on the basis of the average annual wastewater discharge /56/

$$QM = f_{S,QM} * QS,aM + QF,aM$$

QT,aM	Dry weather flow throughout the year	l/s
QS,aM	Yearly waste water discharge	l/s
QF,aM	Extraneous water runoff throughout the year	l/s
wS,d	specific wastewater flow	100 – 150 l/(E*d)
$f_{S,QM}$	Factor to determine the optimum mixing water flow to the treatment plant	l/s

The extraneous water inflow has to be estimated and is interrogated as a percentage of the dirt-water inflow.

## Loads

The given loads for organic loading ( $BOD_5$ ), nitrogen (TKN) and phosphate (P) are in accordance with ATV guidelines without consideration of a preliminary step.

In this form, only those values are selected that are relevant for the computation in accordance with both guidelines. The filterable solids are considered in the dimensioning based on A131, and are entered later after selecting the computation method.

The daily loads are evaluated using specific loads and the population equivalent.

$$\text{Daily load} = \text{population} * \text{specific. load} \quad [\text{kg/d}]$$

The specific  $BOD_5$ -load of  $60 \text{ gO}_2/(\text{PE} * \text{d})$  is suggested. This value can be either accepted or modified by the user.

The value of  $60 \text{ gO}_2/(\text{PE} * \text{d})$  results from a  $BOD_5$ -inflow load without a primary sedimentation step. When a primary sedimentation step is selected, the value for the specific inflow load decreases depending on the detention period in the primary sedimentation step. The corresponding parameters are available in the ATV A131 guideline.

The same applies to nitrogen and phosphate loads.

Parameter	Raw wastewater	Retention time in the presedimentation at Qt	
		0,5-1,0 h	1,5-2,0 h
BSB <sub>5</sub>	60	45	40
CSB	120	90	80
Abf. Stoffe	70	35	25
N	11	10	10
P	1,8	1,6	1,6

Table 1 from the ATV A131 guideline: Wastewater loads in gO<sub>2</sub>/(PE\*d) without consideration of sludge liquor

### Absolute Values

It is very useful to enter actual hydraulic masses and waste concentrations or loads from data analysis when they are available.

Select the option for **Absolute Values** after entering a value for the population equivalent. The window for entering the absolute values appears. Here, values are preselected based on the specific data of the previously entered PE.

AQUA DESIGNER calculates these absolute values based on the ATV guideline recommended specific values and the previously entered population equivalent. This applies to the volumes as well as to the sewage contents.

Fig. 34: Form on loads selecting the option Absolute Quantities

### Wastewater Inflow

In addition to the daily dry-weather flow, a value for extraneous water may be entered to enable the conversion from specific values to absolute values. In the specific values option the extraneous water is included in the displayed value for dry-weather flow. The daily extraneous water is not included in the value for daily dry-weather flow.

### Loads

In the window for absolute values it is again possible to enter the constituents in two separate ways. For data from analysis that are usually given as concentrations choose the option **Concentrations** in the window for **Absolute Values**. AQUA DESIGNER will calculate the load based on the concentrations and the inflow volume.

Project Name: Example 50000

Spec. Quantities  Absolute Quantities

Loads  Concentrations

Industrial Wastewater: 800,00 m3/d

	municipal	Supematant	Industrial Wastewater		
BOD5-Load, total	3000,00		2400,00	5400,00	kg/d
COD-Load, total	6000,00		4000,00	10000,00	kg/d
SS-Load, total	3500,00		800,00	4300,00	kg/d
TKN-Load, total	550,00		88,00	638,00	kg/d
P-Load, total	90,00		16,00	106,00	kg/d
NO3-N-Load, total	0,00		0,00	0,00	kg/d
Dry Weather Flow				668,19	m3/h
Combined Inflow				668,19	m3/h

	municipal	Supematant	Industrial Wastewater		
BOD5-Load, total	2250		1800	4050,00	kg/d
COD-Load, total	4500		3000	7500,00	kg/d
SS-Load, total	1750		400	2150,00	kg/d
TKN-Load, total	500,5		80,08	580,58	kg/d
P-Load, total	80,1		14,24	94,34	kg/d
NO3-Load, total	0,00		0,00	0,00	kg/d

Fig. 35: Form on load, constituents when selecting concentrations

In any case, values for the concentrations of constituents will be suggested based on the previously entered and calculated loads.

Now enter the actual concentrations. AQUA DESIGNER calculates the loads based on the concentrations and the inflow when choosing the option loads. The results from the conversion of absolute values to specific values are displayed when choosing the option specific values.

Values for extraneous water, dry-weather flow and the daily inflow for different constituents have been entered in the window for absolute values. Thus, the fraction of domestic wastewater is known and all specific values can be calculated.

### 7.3.2 Load MSIG or M&E

Metcalf & Eddy **Fehler! Verweisquelle konnte nicht gefunden werden.** is a common international handbook. Because of a development project also the standard of the National Water Services Commission of Malaysia /65/ is shown.

For both standards an average and a peak flow has to be calculated. The peak flow is valid for steps where the retention time is part of the design, e.g. the clarifiers.

#### Wastewater Volume

M&E provides typical values for the municipal flow and the part of infiltration water.

Specific municipal flow	ws,d	230 L/E/d
Specific municipal and infiltration flow	ws,d + wf,d	420 L/E/d

Typical values for the specific municipal wastewater amount

DWA	125	l/E/d
M&E	230	l/E/d
MSIG	225	l/E/d

In AQUA DESIGNER thus the infiltration can be set to 0 % for MSIG and M&E. Infiltration water is then considered by the specific wastewater amount. This is correct in this case, because also the average flow is evaluated for 24 hours.

Daily Inflow  $Q_{d,conc}$ :

$Q_d$        $m^3/d$       valid daily flow for the calculation of concentrations

$$Q_d = EZ * (ws,d + wf,d) \quad [m^3/d]$$

Average Inflow  $Q_{T,aM}$ :

$$Q_{avg} = Q_d/24 \quad [m^3/h]$$

Peak flow  $Q_{peak}$ :

$$Q_{peak} = Q_{avg} * f_{peak} \quad m^3/h$$

**Peak Factor**

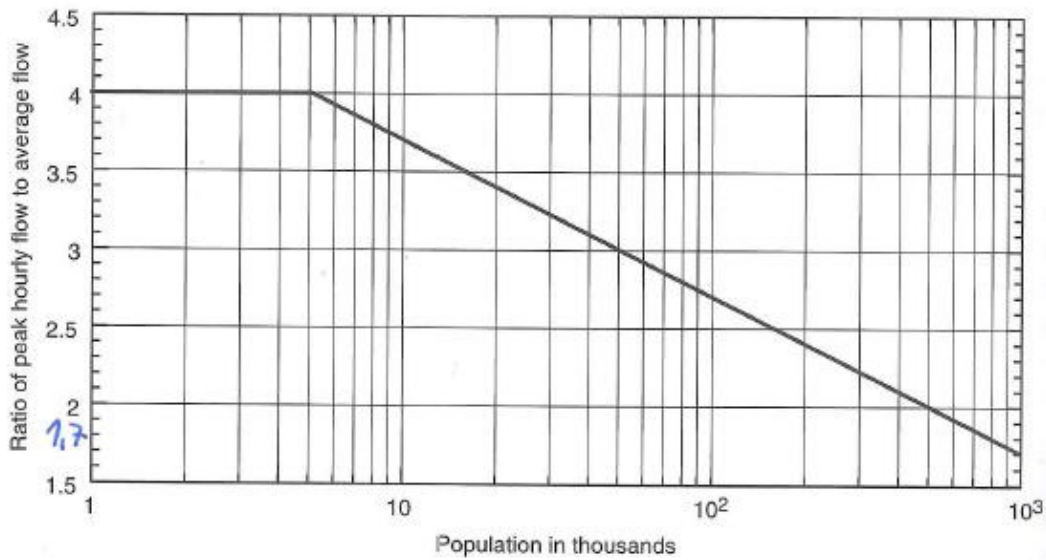

Fig. 36: Peak Factor(Relation of hourly peak to average daily inflow)

Peak Factor for MSIG /65/

$$f_{Peak} = 4,7 * \left( \frac{PE}{1,000} \right)^{-0.11}$$

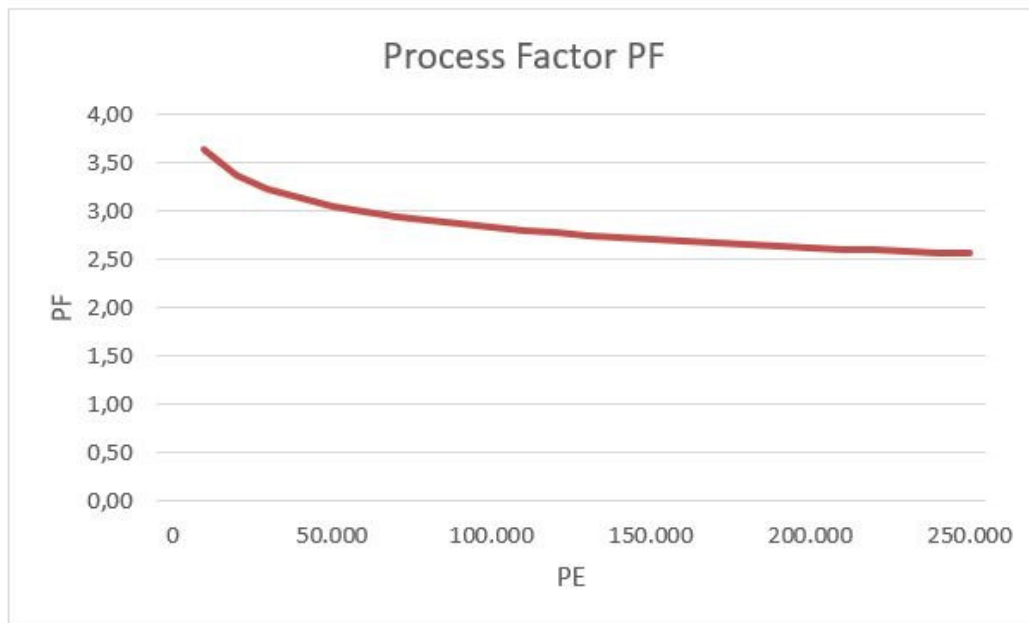

Fig. 37: Process factor MSIG /56/

		DWA	M&E
Daily Inflow	m <sup>3</sup> /d	Q <sub>d,Konz</sub>	Q <sub>d</sub>
Hourly Inflow	m <sup>3</sup> /h	Q <sub>h</sub>	Q <sub>avg</sub>
Dry weather flow, yearly average	l/s	Q <sub>T,aM</sub>	Q <sub>avg</sub>
Rain weather outflow of the wwtp	l/s	Q <sub>M</sub>	
Hourly peak flow	m <sup>3</sup> /h		Q <sub>peak</sub>



Peak Factor			$f_{\text{peak}}$
Factor for wastewater flow at QM		$f_{S,QM}$	

Fig. 38: Nomenclature

Ist difficult to harmonise the nomenclature. M&E and other international standards use the peak flow. The DWA says mixed water flow. These values are calculated and used in different ways for the design.

### Specific Load

Specific loads in g/(Exd), which are undertaken by 85-% of the days	DWA	M & E Table 3-16	MSIG
$C_{BSB5}$	60	76	56
$C_{CSB}$	120	193	113
$X_{TS}$	70	74	68
$C_{KN}$	11	13,2	11
$C_P$	1,8	2,1	2

### Calculation of Variants

Generally ist important to check and verify different cases. Further to the basic design, AQUA DESIGNER enables you to caculate variants for other flows or loads. In the way of design you can enter the original dimensions chosen before. So for chosen dimensions the valid values like sludge age, oxygen demand or retention time can be proved.

## 7.3.3 Internal Response

### Basics

The amount of individual constituents in the recycled turbid water depends primarily on two factors.

The selected wastewater treatment process determines how high the proportion of absorbed constituents is.

Phosphate, which is present in high concentrations in the excess sludge, for example, in the case of increased biological phosphate elimination, must be mentioned here above all.

The type of sludge treatment determines the extent to which the constituents of the surplus sludge are redissolved or converted so that they are present in dissolved form in the sludge water.

Biological phosphate elimination is associated with an alternation of phosphate uptake and phosphate redissolution. Phosphate re-dissolution occurs during the non-

aerated phase. After excess sludge has been removed, phosphate redissolution occurs as a result of prolonged storage of the sludge or during sludge stabilisation. However, Jardin /41/ points out that a large part of the redissolved phosphate remains in the surplus sludge due to precipitation processes.

Sludge treatment depends on the type of wastewater treatment, the plant size and the disposal path. For internal reloading, it is important whether the sludge was simultaneously aerobically stabilised or separately anaerobically or aerobically-thermophilically stabilised.

Anaerobic or aerobic-thermophilic sludge stabilisation converts most of the nitrogen bound in the sludge back into ammonium, which is then present in dissolved form in the sludge water. The nitrogen load returned in the sludge water can impair the purification performance or the effluent values, especially if low effluent values have to be maintained.

With simultaneous aerobic sludge stabilisation, the excess sludge removed is only biologically active to a small extent. The back load is then lower than with separate sludge stabilisation. In addition, plants with simultaneous aerobic sludge stabilisation are not as sensitive to increased influent loads due to the high sludge age.

The type of sludge water produced can be roughly divided into two categories.

In a first step, the extracted excess sludge is mechanically thickened. Depending on the type of sludge, the solids are concentrated from 0.8 - 3 % to 5 - 8 %. Primary sludge has a higher initial solids concentration and can be thickened to higher values. Excess sludge removed from the biological stage is in the lower range of the above intervals.

This step produces the largest amount of sludge water. On the other hand, this fraction is not yet so highly contaminated.

In the second step, the sludge is stabilised separately if necessary and then mechanically dewatered. Here the sludge thickens to 24 - 40 %. The lower value applies to the dewatering of simultaneously aerobically stabilised sludge when dewatering with a Zen-trifuge or belt filter press. The upper value applies to anaerobically stabilised sludge when dewatering with a chamber filter press.

Here, about 10 per cent of the sludge water quantity compared to the previous step is still produced. However, the water is much more contaminated with nitrogen and phosphorus, especially in the case of anaerobic and aerobic-thermophilic sludge stabilisation.

Further dewatering stages such as drying produce only negligibly small additional quantities of sludge water.

**Generell**

Parameter	Analysis Supernatant		
	Minimum mg/l	Maximum mg/l	Average mg/l
BOD <sub>5</sub>	12	3420	690
COD	70	28500 <sup>2)</sup>	2196
N <sub>tot</sub>	258	1810	1025
NH <sub>4</sub> -N	66	1462	746
P <sub>tot</sub>	0,4	1169	86

Extract of Table 3 from ATV Arbeitsbericht „Maschinelle Schlammwässerung /42/“: Concentration in Supernatant and municipal waste water

	COD mg/l	NH <sub>4</sub> -N mg/l	PO <sub>4</sub> -P mg/l
Average	8000	550	12
Scale	2000 – 12000	300 – 750	1 – 31

Table 6 from /41/: Concentrations in supernatant of primary sludge thickening (0,45 μ m filtrated)

**Handling**

Internal responses out of the supernatant of the sludge treatment can be considered very detailed.

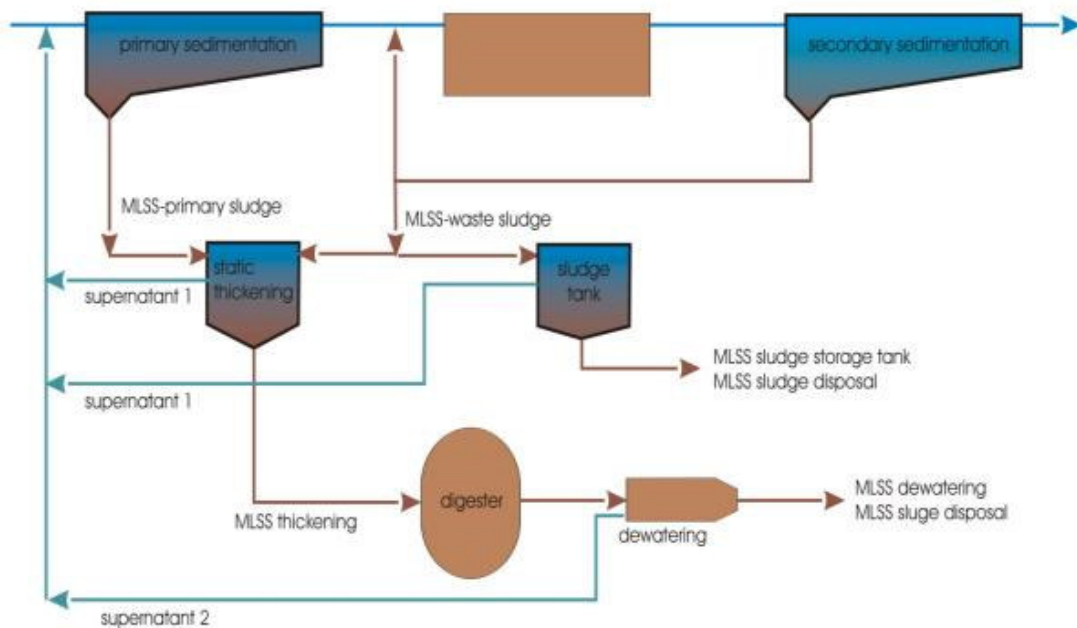

Fig. 39: Flow scheme for supernatant flows

## Simple Calculation

### Concentrations

Concentrations of the supernatant can be entered. The loads of the internal response will be calculated based on the concentrations and the resulting supernatant amount.

Waste Sludge (WS):

$$Q_{WS,0} = \frac{WS_d \frac{kgSS}{kgBOD_5} * B_{d,BOD_5} \frac{kg}{d}}{MLSS_{WS} \frac{kg}{m^3}} \left[ \frac{m^3}{d} \right]$$

Thickened and dewatered waste sludge:

$$Q_{WS,1} = \frac{WS_d \frac{kgSS}{kgBOD_5} * B_{d,BOD_5} \frac{kg}{d}}{MLSS_{WS1} \frac{kg}{m^3}} \left[ \frac{m^3}{d} \right]$$

Supernatant as difference of above volumes:

$$Q_{IS} = Q_{WS0} - Q_{WS1} = WS_d \frac{kgMLSS}{kgBOD_5} * B_{d,BOD_5} \frac{kg}{d} * \left( \frac{1}{MLSS_{WS0} \frac{kg}{m^3}} - \frac{1}{MLSS_{WS1} \frac{kg}{m^3}} \right) \left[ \frac{m^3}{d} \right]$$

Load with volume flow and concentrations:

$$B_{d,SI} = \frac{Q_{SI} \frac{m^3}{d} * c_{SI} \frac{mg}{l}}{1000 \frac{g}{kg}} \left[ \frac{kg}{d} \right]$$

### Percentual Part of the Inlet

The internal response can be chosen as a relation of the inlet loads. The relation will be build to the loads before pre sedimentation.

## Enhanced Calculation

Especially in larger plants you usually have to steps of thickening respectively dewatering. The concentrations of the supernatant out of the thickening in a first step are very different to the concentrations in the supernatant of the dewatering. Therefore an detailed form for the concentrations of these to steps is provided.

## Dimensioning

The loads of the internal response will not be reduced by the pre sedimentation. They are directly added to the inflow loads of the biological stage.

### 7.3.4 Industrial Loads

A daily water volume of 0 m<sup>3</sup>/d is preselected for the trade and industrial component, meaning no commercial or industrial wastewater is present.

#### Wastewater Inflow

If a trade or industrial component needs to be considered, the daily water volume must be entered in the input **Industrial Waste Water**.

By leaving the input field, another window opens for entering the wastewater concentration and the hour index

The hourly wastewater volume results from the daily wastewater volume and hour index.

$$Q_i = \frac{Q_{i,d}}{h_{average}} \quad \left[ \frac{m^3}{h} \right]$$

$$Q_g = \frac{Q_{g,d}}{x} \quad \left[ \frac{m^3}{h} \right]$$

$Q_i, Q_{i,d}$	hourly or daily industrial inflow, respectively	[m <sup>3</sup> /h]
$Q_g, Q_{g,d}$	hourly or daily trade wastewater inflow, respectively	[m <sup>3</sup> /h]
$h_{average}$	hour index	[h/d]
$x$	hourly average	[h/d]

#### Loads

The daily loads for business and industry are evaluated using the given water volumes and concentrations.

$$DailyLoad = \frac{Q_{i,g} * c_{i,g}}{1000} \quad \left[ \frac{kg}{d} \right]$$

$c_{i,g}$	concentration of wastewater component	mg/l
$Q_{i,g}$	wastewater volume current	m <sup>3</sup> /d

### 7.3.5 Total Load

After entering all basic data, click on the button **Calculate**.

A result form with the hourly water volume **and** daily load **appears**.

The result contains the municipal, trade, and industrial loads and water volumes.

Leave the form with **OK**.

### 7.3.6 Pre Sedimentation

#### DWA

If the Pre Sedimentation has been chosen in the Load-Form, this step also will occur in the main-form.

The volume will be chosen by the retention time of the load form. It is based on the average dry weather flow  $Q_{t,aM}$ .

If you want to include more than one chamber, you can enter this under **Options**.

#### MSIG

Further to the retention time the surface and outflow weir is defined. /65/

#### Metcalf & Eddy

The design is base on Overflow Rate and Retention Time. The surface overflow rate determines the surface and the retention time determines the depth.

The recommended values are shown in tabelle 5-19 **Fehler! Verweisquelle konnte nicht gefunden werden**.

Typical design information for primary sedimentation tanks

		Range	Typical
Detention time	H	1,5 – 2,5	2,0
Average Flow Rate	m <sup>3</sup> /m <sup>2</sup> /h	30 – 50	40
Peak Overflow Rate	m <sup>3</sup> /m <sup>2</sup> /h	80 – 120	100
Weir Loading Rate	m <sup>3</sup> /m/d	125 – 500	250

### 7.3.7 Overview of material flows

The flow diagram shows where internal streams from the sludge treatment and industrial inflows are introduced into the water line. The industrial flow enters the plant in front of the primary sedimentation. The loads of the industrial waste water are also reduced by the primary sedimentation.

The supernatant is given to the water line behind the primary sedimentation. So these loads are not reduced by the primary sedimentation step.

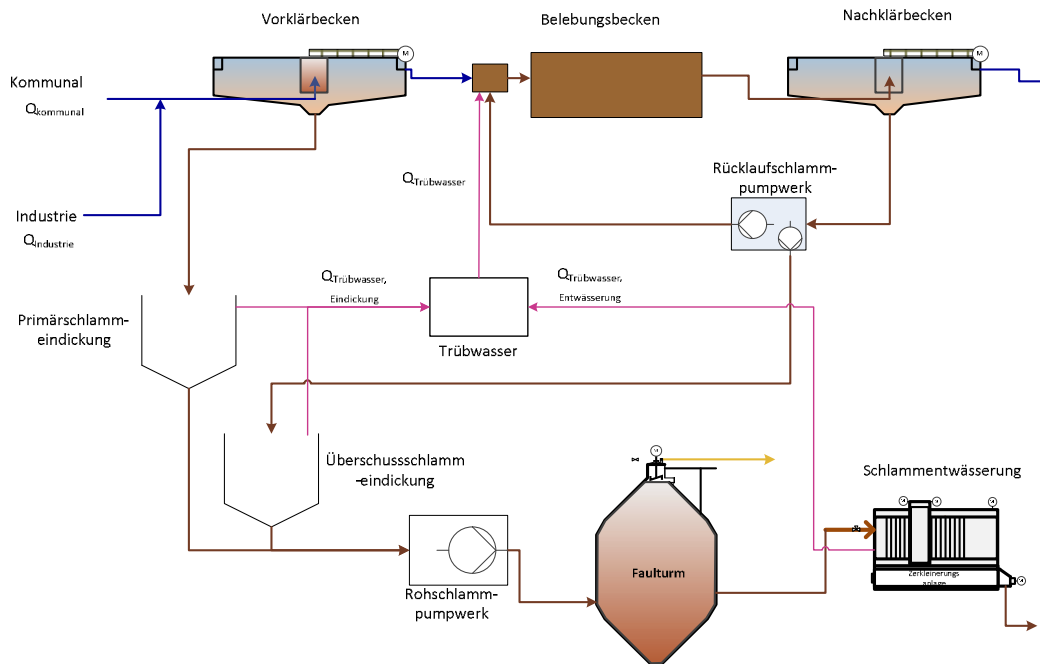

Fig. 40: Material Flows

## 7.4 Choosing a Guideline

The methods of Metcalf & Eddy will stepwise be implemented into AQUA DESIGNER. So you can choose between DWA and M&E for continuous and sequencing batch processes.

In AQUA DESIGNER werden schrittweise die Bemessungsanleitungen aus dem Handbuch Metcalf & Eddy implementiert. Es besteht also die Möglichkeit zwischen der Bemessung nach DWA oder nach Metcalf & Eddy zu wählen. Dies betrifft den Berechnungsgang für kontinuierlich durchflossene Belebungsanlagen nach A 131 und SBR-Anlagen.

Furthermore a model based on the National Water Services Commission of Malaysia /65/ is available.

AQUA DESIGNER is designed for wastewater plants with simultaneous aerobic or anaerobic sludge stabilisation. The method is restricted to the activated sludge process with nitrification and intermittent denitrification. Biological and chemical phosphorus removal can be included in the computation by selecting the respective parameters.

The basis for the layout of the biology are the ATV guidelines A 226 /58/ and A 131 /39/. Depending on the population equivalent, different characteristic values and directions for the calculations arise for dimensioning.

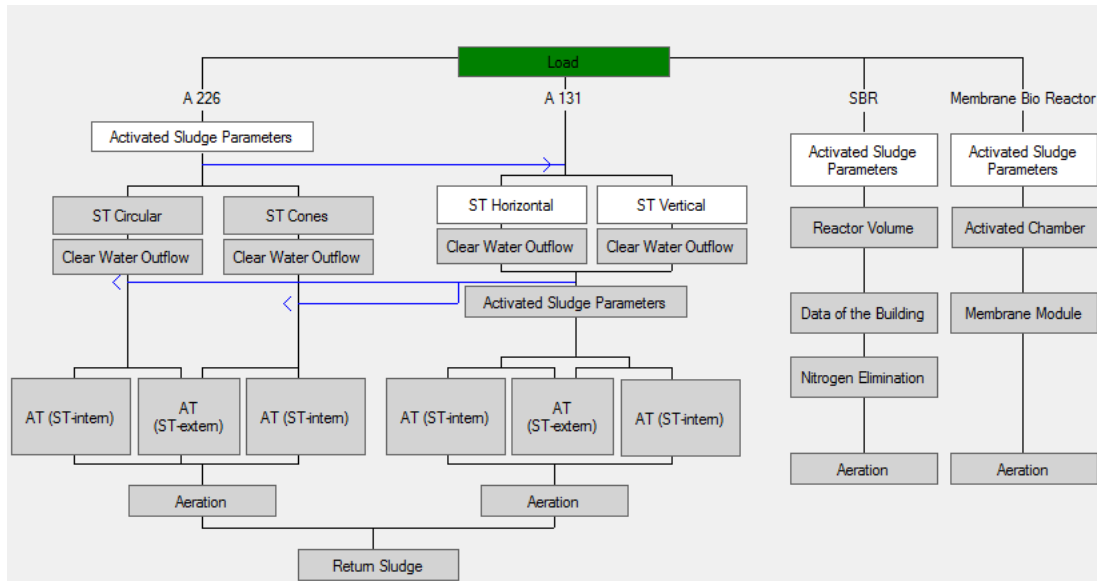

Fig. 41: Main Window for simultaneous aerobic sludge stabilization

### DWA-A131

The A 131 /2/ includes the dimensioning of wastewater treatment plants with simultaneous aerobic sludge stabilisation, and treatment plants with pre-treatment and anaerobic sludge digestion.

The dimension of the secondary sedimentation tanks can be calculated based on the ATV 131 guideline for lower population equivalents as well. This may result in improved tank dimensions under certain influent conditions.

### DWA-A226

The DWA A 226 guideline is employed for wastewater plants operating with the activated sludge process with simultaneous sludge stabilisation for population equivalents of more than 1.000 PE.



## 7.5 Clarification Method

In AQUA DESIGNER different clarification methods are at your choice. Select the clarification method on the menu bar with **Options > Process**.

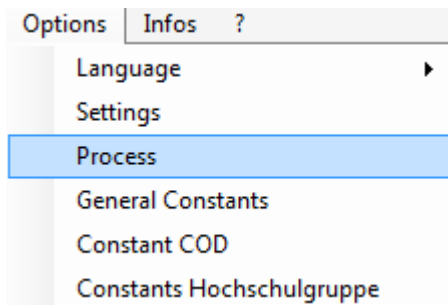

Fig. 42: Options > Process

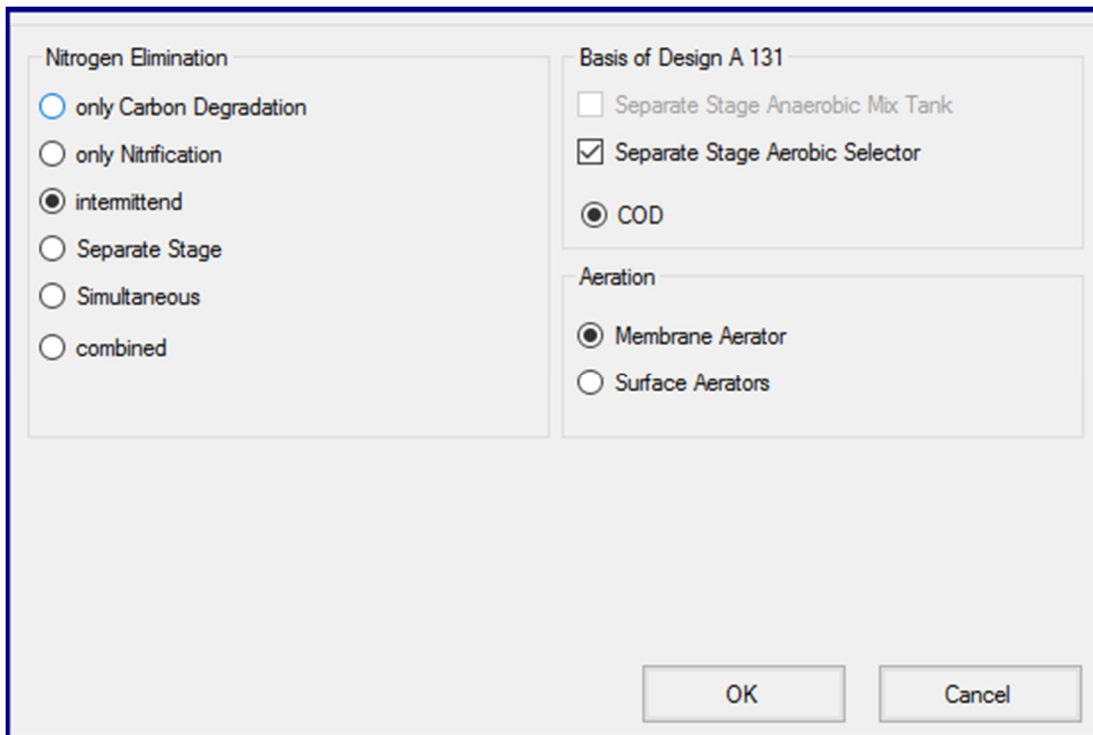

Fig. 43: Selecting a method for nitrogen removal from the menu bar

You must restart with the **Basic Data** form when the method for nitrogen removal is to be changed after a computation has been completed already.

Selecting the method for nitrogen removal is only possible on the level of the Main Window. The menu bar options are inactive while working in computation forms.

The outflow requirements must always be reviewed after selecting a new clarification method as the previously selected outflow values might not meet with the new conditions. For example the nitrate outflow value must be reviewed in the **Basic Data** form when the method for nitrogen removal has changed from 'Only nitrification' to 'Intermittent nitrification'.

### 7.5.1 Only Carbon Degradation

Dimensioning the biological step solely on the carbon compound degradation is available in the ATV guideline A 131 /39/.

The sludge age for the sole carbon compound degradation is listed in Table 2 of the A131 guideline.

Standard of purification	up to 20000 PT	more than 100000 PT
Wastewater clarification without nitrification	5	4

Table 2 from the A131: Minimum sludge age in days depending on the standard of purification and the wastewater plant size (Intermediate values are to be estimated)

Values between the population equivalent of 20000 and 100000 are interpolated linear.

In the aeration the factors  $f_C$  and  $f_N$  are adapted to the selected method of purification.

For only carbon degradation the following sludge ages are recommended by /64/, Tabelle 6.1

Water temperature $T_w$ [°C]	Recommended sludge age SRT $t_{RS}$ [d]
< 10	4
Up to 20	3
> 20	(2) 3 incl. anoxic Volume or Phases

For temperature over 20°C a dimensioning for nitrification and at least partly denitrification is recommended.

## 7.5.2 Only Nitrification

Dimensioning the biological step only with nitrification is available based on the DWA guideline and based on the university algorithm.

### DWA-A131 Guideline

The DWA-A 131 /2/ guideline also gives reference values for the required sludge age in nitrification.

Standard of purification	<= 20000 EW		> 100000 EW	
	10°C	12°C	10°C	12°C
Wastewater clarification with nitrification	10	8,2	8	6,6

Table 3 from ATV-A131

Process factor	<= 20.000 EW	> 100.000 EW
PF	1,8	1,45

Table 4: Minimum sludge age in days, depending on the cleaning target and the size of the plant ((Table 2 of A131; intermediate values are to be estimated)

Intermediate values for the safety factor have to be interpolated.

Aerobic sludge age:

$$T_{SS,A} = SF * 3,4 * 1,103^{(15-T)} \quad [d]$$

SF = safety factor for nitrification

Aerobic sludge ages should not be taken under 2 days for higher temperature. /64/.

If there is a favorable feed situation, your selected safety factor SF can deviate from the recommendations of the DWA. If the feed is homogenized by feed-pumping stations, or the feed is buffered, you can choose a safety factor SF, which is below the DWA value. Select a specific safety factor by selecting the check box on the form A131 Parameter Activated Sludge Process and then enter a free value.

### DWA-A226 Guideline

Selecting the DWA-A226 automatically includes the aerobic sludge stabilization method. Here the dimensioning based on the sole nitrification method must be reviewed for economical reasons.

## University Algorithm

The dimensioning based on the university algorithm is described separately.

## 7.5.3 Nitrification and Denitrification

### Generell

For dimensioning the biological step of nitrification and denitrification, the four processes separate stage, simultaneous and intermittent denitrification, also combined separate stage/ intermittent denitrification are available. Additionally, you can choose the before mentioned processes running in a way of cascades.

### DWA-A 226

The dimensioning based on the DWA A226 guideline only applies to the intermittent denitrification. The selected method of clarification only affects the aeration period.

### Surplus Sludge Production

Total Surplus Sludge

$$WS_d = WS_{d,C} + WS_{d,P} \text{ [kg/d]}$$

Surplus Sludge from Carbon Degredation

$$WS_{d,C} = WS_{BOD} * B_{d,BOD} = 1,0 * B_{d,BOD} \quad \text{[kg/d]}$$

Surplus Sludge from Phosphate Elimination

Precipitant Iron  $FeCl_3$

$$WS_{d,P} = 0,1 * WS_C$$

Precipitant Aluminium  $AlCl_3$

$$WS_{d,P} = 0,08 * WS_C$$

### Volume of the activated chamber

Sludge age for simultaneous aerobic sludge stabilization and nitrification

$$t_{TS} \geq 20 \text{ d}$$

Sludge age for simultaneous aerobic sludge stabilization and denitrification

$$t_{TS} \geq 25 \text{ d}$$

MLSS, Biomass in the activated chamber

$$M_{TS,AT} = t_{TS} * WS_d \quad \text{[kg]}$$

Volume of the activated chamber

$$V_{AT} = \frac{M_{TS,AT}}{TS_{AT}} \quad [m^3]$$

For the calculation of the MLSS ( $TS_{AT}$ ) see the dimensioning of the secondary sedimentation

Required activated volume

$$V_{AT} = \frac{EW_{BOD,60} * f_{AT}}{1000} \quad [m^3]$$

$f_{BB}$  will be printed as result. It can be verified by the tables 2 and 3 in the A 226 /58/.

Sludge loading for common municipal wastewater

Nitrification

$$B_{TS,BOD} \leq 0,05 \text{ [kg/(kg*d)]}$$

Nitrification/Denitrification

$$B_{TS,BOD} \leq 0,04 \text{ [kg/(kg*d)]}$$

### DWA-A 131 2016

The design is based on the CSB. First, a fractionation of the CSB can be carried out with the help of factors. If primary treatment was selected, the values according to primary treatment are applied for the dimensioning of the aeration tank.

From the load is given:

In the feed:

COD concentration in the homogenized sample	$C_{COD,Z}$	mg/l
Concentration of filterable (with 0,45 mm membrane filter) substances after drying at 105°C	$X_{TS,Z}$	mg/l
Concentration of the kjeldal nitrogen (KN=org. N+NH4-N) in the homogenized sample	$C_{KN,Z}$	mg/l
Concentration of phosphorus in the homogenized sample as phosphorus	$C_{P,Z}$	mg/l
Concentration of the nitrate nitrogen in the filterable sample as nitrogen	$S_{NO3,Z}$	mg/l

After primary treatment

COD concentration in the homogenized sample	$C_{COD,ZB}$	mg/l
Concentration of filterable (with 0,45 mm membrane filter) substances after drying at 105°C	$X_{TS,ZB}$	mg/l
Concentration of the kjeldal nitrogen (KN=org. N+NH4-N) in the homogenized sample	$C_{KN,ZB}$	mg/l

Concentration of phosphorus in the homogenized sample as phosphorus	C <sub>P,ZB</sub>	mg/l
Concentration of the nitrate nitrogen in the filterable sample as nitrogen	S <sub>NO3,ZB</sub>	mg/l

### Fractionation of the COD

Proportion of the inorganics in the filterable solids (ignition residue); in the selection of a factor some comments have influence on an article in the KA of 02/2016 /62/ f <sub>B</sub> = 0,3 without primary sedimentation f <sub>B</sub> = 0,2 with primary sedimentation	f <sub>B</sub>	-
Inert part of the particulate COD /62/ f <sub>A</sub> = 0,2 – 0,35 typical municipal wastewater f <sub>A</sub> = 0,3	f <sub>A</sub>	-
Proportion of the easily degradable on the degradable COD f <sub>CSB</sub> = 0,15 – 0,25	f <sub>COD</sub>	-
Part of the solved COD of total COD f <sub>S</sub> = 0,05 – 0,1 typical municipal wastewater f <sub>S</sub> = 0,05	f <sub>S</sub>	-

$$X_{\text{COD,ZB}} = X_{\text{TS,ZB}} * 1,6 * (1-f_B)$$

$$S_{\text{COD,ZB}} = C_{\text{COD,ZB}} - X_{\text{COD,ZB}}$$

$$S_{\text{COD,inert,ZB}} = 0,05 * C_{\text{COD,ZB}}$$

$$X_{\text{COD,inert,ZB}} = f_A * X_{\text{COD,ZB}}$$

$$C_{\text{COD,abb,ZB}} = C_{\text{COD,ZB}} - S_{\text{COD,inert,ZB}} - X_{\text{COD,inert,ZB}}$$

$$C_{\text{COD,la,ZB}} = f_{\text{COD}} * C_{\text{COD,abb,ZB}}$$

$$X_{\text{anorg,TS,ZB}} = f_B * X_{\text{TS,ZB}}$$

### Design Temperature

Design temperature is the temperature which is required for nitrogen removal.

In Germany is this temperature according to the waste water regulations:

$$T_{\text{Bem}} = T_{\text{ÜW}} = 12^\circ\text{C}$$

### Aerobic Sludge Age

A safety factor is established for a protected nitrification process.

$f_N$	1,4	1,6	1,8	2,0	2,2	2,4
$S_{\text{NH}_4,\text{ÜW}}$						
5 mg/l NH <sub>4</sub> -N	1,5	1,6	1,9	2,2	2,5	2,8
10 mg/l NH <sub>4</sub> -N	1,5	1,5	1,5	1,6	1,9	2,1

Fig. 44: Table 3 DWA-A 131/2/, Required safety factor in dependence on the NH<sub>4</sub>-N observation value in the effluent and the variation of the KN influent load (intermediate values can be interpolated)

$$t_{TSa} = PF * 3,4 * 1,103^{(15 - T_{Bem})} \text{ d}$$

$T_{Bem}$  design temperature °C

### Excess sludge production from the carbon elimination

To the waste water feed related COD concentration of excess sludge

$$X_{COD,WS} = X_{COD,inert,ZB} + X_{COD,BM} + X_{COD,inert,BM}$$

COD from biomass

$$X_{COD,BM} = (C_{COD,abb,ZB} * Y + C_{COD,Dos} * Y_{COD,Dos}) * \frac{1}{1 + b * t_{TS} * F_T}$$

Yield coefficient

$$Y = 0,67 \quad \text{g/g}$$

Yield coefficient from an external carbon source

$Y_{COD,Dos}$  from table 1 /2/

Disintegration coefficient

$$b = 0,17 \quad \text{d}^{-1}$$

temperature factor for endogenous respiration

$$F_T = 1,072^{(T-15)}$$

Inert part of COD from biomass

$$X_{COD,inert,BM} = 0,2 * X_{COD,BM} * t_{TS} * b * F_T$$

Daily sludge production from carbon elimination

$$WS_{d,C} = Q_{d,Konz} * \left( \frac{X_{COD,WS}}{0,8 * 1,45} + X_{anorgTS,ZB} \right) / 1000 \quad \left[ \frac{\text{kg}}{\text{d}} \right]$$

### Excess Sludge Production From Phosphorus Elimination

Concentration of phosphorus in the homogenized sample as phosphorus, in the influent of the aeration tank	$C_{P,ZB}$	mg/l
Concentration of phosphorus in the homogenized sample as phosphorus, in the effluent of the secondary settlement	$C_{P,AN}$	mg/l
Phosphorus in the biomass	$X_{P,BM}$	mg/l
The biological bound phosphorus from the biological phosphorus removal	$X_{P,bioP}$	mg/l
Eliminated phosphorus from the precipitation	$X_{P,Fäll}$	mg/l

$$WS_{d,P} = Q_{d,Konz} * (3 * X_{P,bioP} + 6,8 * X_{P,Fäll,Fe} + 5,3 * X_{P,Fäll,Al}) / 1000 \quad [\text{kg/d}]$$

$$X_{P,BioP} = 0,006 * C_{CSB,ZB} \quad [mg/l]$$

$$X_{P,BM} = 0,005 * C_{CSB,ZB} \quad [mg/l]$$

$$X_{P,Fäll} = C_{P,ZB} - C_{P,AN} - X_{P,BM} - X_{P,BioP} \quad [mg/l]$$

$$WS_{d,P} = Q_{d,Konz} * (3 * X_{P,bioP} + 6,8 * X_{P,Fäll,Fe} + 5,3 * X_{P,Fäll,Al})/1000 \quad [kg/d]$$

### Total Excess Sludge Production

$$WS_d = WS_{d,C} + WS_{d,P} \quad [kg/d]$$

### Calculation of the denitrifying nitrate nitrogen concentration

Concentration of nitrogen as total nitrogen in the homogenized sample, in the influent of the aeration tank	$C_{N,ZB}$	mg/l
Concentration of the dissolved organic nitrogen in the effluent of the secondary settlement, can be set at 2 mg/l	$S_{orgN,AN}$	mg/l
Concentration of the Ammonia nitrogen in the filterable sample, in the effluent of the secondary settlement (generally in the dimensioning this value is set to 0 mg/l for safety)	$S_{NH4,AN}$	mg/l
Concentration of the nitrate nitrogen in the filterable sample, in the effluent of the secondary settlement	$S_{NO3,AN}$	mg/l
In the biomass bound organic nitrogen	$X_{orgN,BM}$	mg/l
To particulate inert substances bound organic nitrogen	$X_{orgN,inert}$	mg/l

$$S_{NO3,D} = C_{N,ZB} - S_{orgN,AN} - S_{NH4,AN} - S_{NO3,AN} - X_{orgN,BM} - X_{orgN,inert} \quad [mg/l]$$

$$X_{orgN,BM} = 0,07 * X_{COD,BM} \quad [mg/l]$$

$$X_{orgN,inert} = 0,03 * (X_{COD,inert,BM} + X_{COD,inert,ZB}) \quad [mg/l]$$

### Oxygen demand for the carbon reduction

COD concentration in the homogenized sample in the influent of the aeration tank	$C_{COD,abb,ZB}$	mg/l
Concentration of the COD increase by external carbon for improvement of the denitrification	$C_{COD,dos}$	mg/l
COD biomass	$X_{COD,BM}$	mg/l
Inert part of the COD biomass	$X_{COD,inert,BM}$	mg/l

$$OV_C = C_{COD,abb,ZB} + C_{COD,dos} - X_{COD,BM} - X_{COD,inert,BM} \quad [mg/l]$$

### Oxygen demand for the denitrification zone

For the determination of the volume proportion for the denitrification the oxygen demand in the denitrification zone is calculated  $OV_{C,D}$ .  $OV_{C,D}$  is different for the different denitrification processes.



BITControl	AQUA DESIGNER 9.2 - Manual	Seite: 71 von 314
	7 Dimensioning	Version: 92-00

The oxygen demand for the denitrification zone  $OV_{C,D}$  is composed of the oxygen demand of the easily degradable COD  $OV_{C,la}$  and the oxygen demand of the carbon reduction  $OV_C$ .

### **Intermittent Denitrification**

The oxidation of ammonium to nitrate and the reduction of nitrate to  $N_2$  and water is managed by alternate aerated and unaerated periods in the intermittent denitrification. The unaerated period per day is equal to the evaluated ratio of the denitrification volume to the total volume. This evaluated aeration period is suggested in the programs aeration window.

This implies that the aeration period in intermittent denitrification must be designed larger than the aeration period in the combined nitrification/denitrification and the simultaneous denitrification.

The mixing devices are designed for the total volume.

The good controllability and the theoretically high denitrification rates by high internal recirculation are the advantages of the intermittent denitrification method. While in the combined nitrification/denitrification method a maximum recirculation rate of 4 is recommended the completely mixed tanks may be suggested for recirculation rates of 20.

$$OV_{C,la,int} = C_{COD,dos} * (1 - Y_{COD,dos})$$

$$OV_{C,D} = 0,75 * (OV_{C,la,int} + (OV_C - OV_{C,la,inter}) * V_D/V_{AT}) \quad [mg/l]$$

### **Seperate Stage Denitrification**

The required recirculation rate results from the outflow requirements for ammonium and nitrate.

Recirculation rate (RZ):

$$RZ_{total} = \frac{[N]_o - [NH_4 - N]_e}{[NO_3 - N]_e - [NO_3 - N]_o} - 1$$

From this value the return ratio must be deducted to get the internal recirculation rate.

Internal recirculation:

$$RC = RC_{total} - RS$$

RS = Return sludge ratio

The graphical surfaces and the constructional values are not available to the same extend in the combined nitrification/denitrification method as it is the case for the other clarification methods.

External tanks are available as circular tanks or rectangular tanks after deciding on the secondary sedimentation tank. In the form A131 for the activated sludge tank the external measurements of the construction are determined.

The values given in the A131 form on the activated sludge tank, however, are sufficient to determine the aeration and mixing.

An aeration period of 24 hours and aeration without separate mixing in the nitrification tank are suggested in the A131 aeration form when combined nitrification/denitrification is selected.

The mixing design is only based on the denitrification volume.

The type and size of the grids can be determined in the graphical surface "membrane aeration".

The graphical presentation of the tank shows only the nitrification volume.

Drawings for the whole biology are not available in the combined nitrification/denitrification. Only an output of the nitrification tank is available. Thus, it is possible to graphically document the distribution of aeration.

The calculation of operation costs is fully available in the combined nitrification/denitrification. The recirculation rate is included into the calculation of operation costs.

### Simultaneous Denitrification

As in the case of separate stage denitrification, the aeration is dimensioned for 24 hours. The agitators are designed for the total volume. The simultaneous denitrification can only be inaccurately regulated, since the nitrification and denitrification times are achieved by circulation through aerated and unaerated zones.

For the calculation according to university approach, the respiratory increasing factor for simultaneous denitrification is set to  $a = 1$ . This will be pointed out separately in the chapter on the university approach.

$$OV_{C,D} = 0,75 * OV_C * V_D/V_{AT} \quad [\text{mg/l}]$$

### Combined Separate Stage/ Intermittent Denitrification

If at least 15% of the total volume are provided as a denitrification stage, the whole system can be dimensioned as separate stage denitrification.  $OV_{C,D}$  is then calculated proportionally for the fractions of the denitrification processes.

$$OV_{C,la,vorg} = f_{COD} * C_{COD,abb,ZB} * (1-Y) + C_{COD,dos} * (1-Y_{COD,dos}) \quad [\text{mg/l}]$$

$$OV_{C,D,vorg} = 0,75 * (OV_{C,la,vorg} + (OV_C - OV_{C,la,vorg}) * (V_D/V_{AT,vorg})^{0,68}) \quad [\text{mg/l}]$$

$$OV_{C,la,int} = C_{COD,dos} * (1-Y_{COD,dos})$$

$$OV_{C,D,int} = 0,75 * (OV_{C,la,int} + (OV_C - OV_{C,la,int}) * V_D/V_{AT,int}) \quad [\text{mg/l}]$$

BITControl	AQUA DESIGNER 9.2 - Manual	Seite: 73 von 314
	7 Dimensioning	Version: 92-00

$$OV_{C,D} = OV_{C,D,vorg} + OV_{C,D,int} \quad [\text{mg/l}]$$

### **Intermitting, Simultaneous Denitrification**

Within the intermitting denitrification, the possible nitrate reduction is not restricted by the mass flow in defined zones. The theoretical recirculation rate compared to the separate stage denitrification is relatively high. Therefore the possible nitrate reduction is governed by the denitrification capacity.

Given outlet values for ammonia and nitrate are resulting in necessary denitrification capacity and denitrification ratio. Looking at the balance of the cascade basins it is obvious that the mass balance for each basin is the same.

This condition is valid assuming a BOD<sub>5</sub>-concentration of 0 mg/l in the return sludge. Even if assuming a BOD<sub>5</sub> value of more than 0 only a slight change in the necessary denitrification capacity and the resulting denitrification ratio will be observed.

Following those assumptions the denitrification ratio in each cascade basin is the same, should you have chosen intermitting denitrification. The same is true for the simultaneous denitrification.

### **Cascaded Denitrification**

#### **Generell**

Cascaded Denitrification means that waste water or sludge run through subsequent basins, a so-called basin cascade. The procedural advantages of a Cascaded Denitrification arise from the way the waste water stream is distributed to the cascades.

In the simplest form the return sludge is fed to the first cascade, the incoming material is equally distributed to all of the cascades.

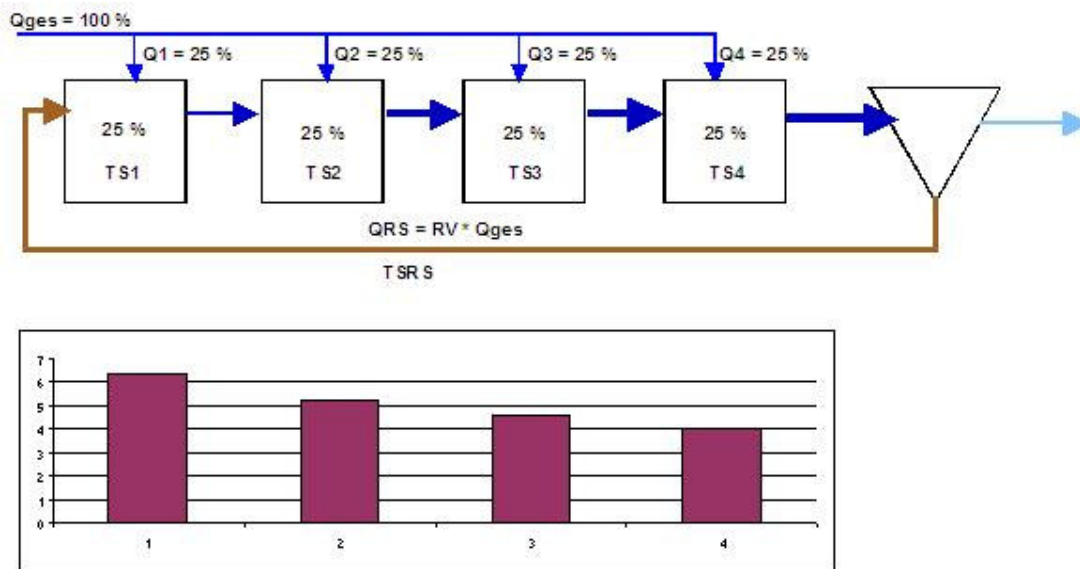

Fig. 45: MLSS for RS = 1 resp. QRS = Qges; "TS" means SS

The figure above shows a cascade of four stages. 25% of the inlet are distributed to the cascades. The recirculation ratio for the following explanations is assumed to be RV = 1.

Cascade denitrification offers two procedural advantages which justify the higher structural complexity under certain conditions.

### MLSS-Concentration

Since the waste water inlet is equally distributed to the cascades the mixing ratio of inlet and return sludge corresponding to the ratio of an uncascaded basin is only reached within the last cascade.

MLSS in the first basin:

$$SS_{AT,1} = \frac{Q_{RS} * SS_{RS}}{Q_{RS} + Q_{tot} * 0,25} = \frac{1}{1,25} * SS_{RS} = 6,40 \quad \left[ \frac{kg}{m^3} \right]$$

with  $SS_{RS} = 8 \text{ kg/m}^3$  and  $Q_{RS} = Q_{ges}$

MLSS in the second basin:

$$SS_{AT,2} = \frac{(Q_{RS} + Q_{tot} * 0,25) * SS_{AT,1}}{Q_{RS} + Q_{tot} * 0,5} = \frac{1,25}{1,5} * 6,4 = 5,33 \quad \left[ \frac{kg}{m^3} \right]$$

MLSS in the third basin:

$$SS_{AT,3} = \frac{(Q_{RS} + Q_{tot} * 0,5) * SS_{AT,2}}{Q_{RS} + Q_{tot} * 0,75} = \frac{1,5}{1,75} * 5,33 = 4,56 \quad \left[ \frac{kg}{m^3} \right]$$

MLSS in the fourth basin:

$$SS_{AT,4} = \frac{(Q_{RS} + Q_{tot} * 0,75) * SS_{AT,3}}{Q_{RS} + Q_{tot}} = \frac{1,75}{2} * 4,56 = 3,99 \quad \left[ \frac{kg}{m^3} \right]$$

Average MLSS with equal distribution to equally sized basins:

$$SS_{AT} = \frac{6,40 + 5,33 + 4,56 + 3,99}{4} = 5,1 \quad \left[ \frac{kg}{m^3} \right]$$

The average MLSS increases because of keeping the basins as cascades from 4,00 to 5,10 kg/m<sup>3</sup>.

SS <sub>AT</sub>	MLSS in the Aerobic Chamber	kg/m <sup>3</sup>
SS <sub>RS</sub>	MLSS in the Return Sludge	kg/m <sup>3</sup>
Q <sub>RS</sub>	Return sludge volume	m <sup>3</sup> /h
Q <sub>tot</sub>	Total inflow	m <sup>3</sup> /h
SS <sub>i</sub>	Inflow MLSS for each chamber	kg/m <sup>3</sup>

## Separate Stage Denitrification

The Cascaded Denitrification is mostly connected to a separate stage denitrification. Should the separate stage denitrification be represented by several cascades which succeed each other, it will be possible to denitrify the nitrate from denitrification stage n in the following denitrification stage n+1.

Assuming a complete nitrification and denitrification (as for the separate stage denitrification) within the basins an efficiency factor depending on the number of stages can be determined.

$$\frac{Q}{n} * (NH_4 - N)_{Nit} = Q * (1 + RS) * (NO_3 - N)_e$$

$$\eta_D = \frac{(NO_3 - N)_D}{(NO_3 - N)_D + (NO_3 - N)_e} = 1 - \frac{1}{n * (1 + RS)}$$

Since the denitrification's efficiency factor arises from a pure mass balance where a complete nitrification and denitrification in the individual stages is assumed the nitrate outlet is not mentioned; it is a part of the mass balance.

## Operating

### Choosing Process

Regardless of which denitrification procedure you have chosen (i.e. intermitting, simultaneous or separate stage denitrification) you are able to choose cascaded denitrification. Your chosen denitrification process will then be assumed to take place within the individual cascade basin.

Therefore cascaded denitrification means a combination of a denitrification procedure and a certain arrangement of the basins within the cascade.

In the menu bar choose **Options > Process**. Within the nitrogen elimination a cleaning process is always given as an option. You can now tick the Cascaded Denitrification on or off.

### User Screen

If you have chosen Cascaded Denitrification then there will only be a little more input for the Form Basic Data necessary.

Giving the separate stage denitrification the nitrate outlet concentration is given by the mass balance. Given the simultaneous and the intermitting denitrification the denitrification ratio results from the nitrate outlet value.

The dry solid concentration is calculated by the dry solid concentration within the return sludge and the mixing ratio.

As soon as you have finished the input in the form Parameter Activated Sludge Process, you will reach the screen Calculation Data for the Cascaded Denitrification by hitting OK. Here you have extensive tools at your disposal that allow for a multitude of different dimensioning variations for the Cascaded Denitrification.

Inflow Concentrations:  
 BOD5 347.83 mg/l  
 TKN 63.77 mg/l  
 NO3-N 0.00 mg/l

Number of Cascades: 3

discharge conc. (Total):  
 NO3-N 10.00 mg/l  
 NH4-N 2.00 mg/l  
 org. N 2.00 mg/l  
 PO4-P 6.36 mg/l

Inflow: 33.33% (Q1zu), 33.33% (Q2zu), 33.34% (Q3zu)

Volume (m³): Chamber 1: 254.00, Chamber 2: 254.00, Chamber 3: 254.00

MLSS(BB) (kg/m³): Chamber 1: 5.11, Chamber 2: 4.67, Chamber 3: 3.78

Sludge load (kg/(m³·d)): Chamber 1: 0.002, Chamber 2: 0.042, Chamber 3: 0.052

Vol. load (kg/(m³·d)): Chamber 1: 0.197, Chamber 2: 0.197, Chamber 3: 0.197

VD/VAC: Chamber 1: 0.310, Chamber 2: 0.310, Chamber 3: 0.310

Denit. capacity (kg/kg): Chamber 1: 0.093, Chamber 2: 0.093, Chamber 3: 0.093

NO3-N conc. (Duff) (mg/l): Chamber 1: 10.00, Chamber 2: 10.00, Chamber 3: 10.00

	Qrück	Q1zu	Beck. 1	Q1ab	Q2zu	Beck. 2	Q2ab	Q3zu	Beck. 3	Q3ab
B5B5-Load (kg/d)	0	50.00	0	0	50.00	0	0	50.01	0	0
TKN-Load (kg/d)	0	9.17	0	0	9.17	0	0	9.17	0	0
NO3-N-Load (kg/d)	3.23	0	0	4.67	0	0	6.11	0	0	7.55
org.-N-Load (kg/d)	0.65	0	0	0.93	0	0	1.22	0	0	1.51
NH4-N-Load (kg/d)	0.65	0	0	0.93	0	0	1.22	0	0	1.51
Inloop. N-Load (kg/d)	-	-	2.50	-	-	2.50	-	-	2.50	-
Denitrif. N-Load (kg/d)	-	-	4.65	-	-	4.65	-	-	4.66	-

RS: 0.75  
 MLSS-RS: 8.82 kg/m³

Total View:  
 dry solid in the activated: 4.85 kg/hr  
 Sludge load: 0.041 kg/kg  
 Volume load: 0.197 kg/m³  
 min. sludge age (aerob): 8.21 d  
 min. sludge age (total): 25.00 d  
 VD/VAC: 0.310  
 denit capacity: 0.093 kg/kg  
 Volume: 762.00 m³  
 Max. BOD5-Load: 150.16 kg/d  
 Chosen BOD5-Load: 150.00 kg/d

Options:  
 as input values  
 Same volume and Sludge Load  
 Same volume  
 Same feed and volume  
 Same feed, Volume and VD/VBB

Buttons: Calculate, OK, Cancel

Fig. 46: Form Cascaded Denitrification

### Number of Cascades

From the list **Number of Cascades** you can choose up to four cascades. The achievable average dry matter content and the achievable nitrate effluent concentration depend on the number of cascades.

### Volume of Cascades

The necessary volume of the cascades is calculated on the basis of the current input data and is equally distributed on each cascade. The wastewater distribution is proposed that a uniform sludge load results over all cascades.

### Variations

The cascades can be loaded and designed using different ways. AQUA DESIGNER allows for the following cases:

- Calculation on basis of directly entered volumina and ways of loading
- Calculation for same volumina. You can choose the loading, thus the volumina remains the same.
- Same loading and same volumina. For the operation it is best to have the same operational conditions in each basin. That makes it more manageable and controllable for the operating personal.
- Same volumina and same sludge loading. The sludge loading is crucial to the biological processes. The same sludge loading is reached by chosing different loading rates for the cascade basins. If you have chosen this option the loading rate is calculated through an iteration process.

- Same volumina, loading rate and denitrification conditions. This setting is the most manageable concerning operation. Each basin will be dealt with equally and each basin has the same geometry. You will certainly have different sludge loading rates. Using a state of the art measurement and regulating equipment the aeration is adjusted independently. It is not mathematically possible to have the same denitrification conditions in each basin. There will always be different conditions for BOD<sub>5</sub>/NO<sub>3</sub> as in the following basins, since at this point only nitrate from the returning sludge is denitrified. This is solved by increasing the denitrification volume in the first basin. The overall volume of the basin is not changed, therefore the nitrification volume decreases. Since the aerobic volume is reduced the system is calculated repeatedly until the aerobic sludge age is within an acceptable range. I.e. same denitrification conditions lead to a overall volume that is slightly higher than that which is necessary for a minimum dimensioning.

## Results

The calculation screen shows the results in detail. The design parameters of each cascade are shown. Additionally the mass balance of each cascade basin is given according to the freight in a tabular format.

The overall results result from the average contents of dry solids in the whole system and the nitrogen balance.

## Simultaneous Denitrification

As it is the case in the separate stage denitrification, the aeration period is dimensioned for 24 hours. The mixing devices are designed for the total volume.

The regulation of the simultaneous denitrification is inexact as nitrification and denitrification periods are induced by the change of aerated and unaerated periods.

In the calculation based on the university algorithm, the respiration elevation factor for simultaneous denitrification is set as  $a = 1$ . This is explained separately in the chapter on the university algorithm.

$$OV_{C,D} = 0,75 * OV_C * V_D/V_{AT} \quad [\text{mg/l}]$$

## Separate stage denitrification

If at least 15 % of the total volume are planned for the denitrification stage, the total system is dimensioned as separate stage denitrification.

$$OV_{C,la,int} = f_{COD} * C_{COD,abb,ZB} * (1-Y) + C_{COD,dos} * (1-Y_{COD,dos}) \quad [\text{mg/l}]$$

$$OV_{C,D} = 0,75 * (OV_{C,la,int} + (OV_C - OV_{C,la,inter}) * (V_D/V_{AT})^{0,68}) \quad [\text{mg/l}]$$



## 7.5.4 External C-Dosage

### Generell

The validity of the DWA A 131E is bounded on the denitrification proportion by 0,6. You will get a message if the calculation results in a larger denitrification ratio. Then external carbon dosage should be added.

In AQUA DESIGNER you can calculate the external carbon dosage choosing the dimensioning approach A 131E.

The addition of the external carbon source affects the calculation of the complete biology. It also affects the denitrification proportion and sludge production.

Typical sources of carbon are methanol, ethanol or acetic acids. An industrial carbonic residual water is also often used.

If you add an external carbon to the process, you should adjust the exact dosage to avoid cumulative carriage of carbon in the drain.

### **Limits of dimensioning:**

Even with carbon dosing, the denitrification ratio should not be higher than 0.6. If you select a larger value for carbon dosing, e.g. 0.61, you will be informed by a message that you are leaving the limits of DWA-A 131.

### Points of Inflection

It is possible to integrate the carbon dosage into the process in different points. Here are several examples for denitrification in the upstream stage.

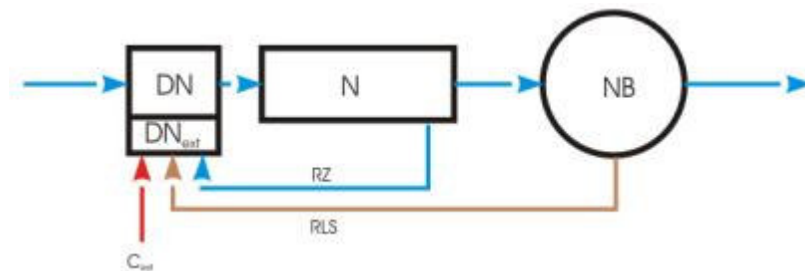

Fig. 47: Integration into the denitrification in a separate basin (DN = Denitrifikation, N = Nitrifikation, NB = ST = sedimentation tank)

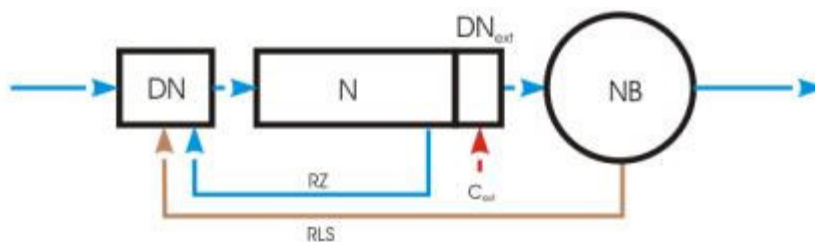

Fig. 48: Integration into the denitrification basin in the downstream stage

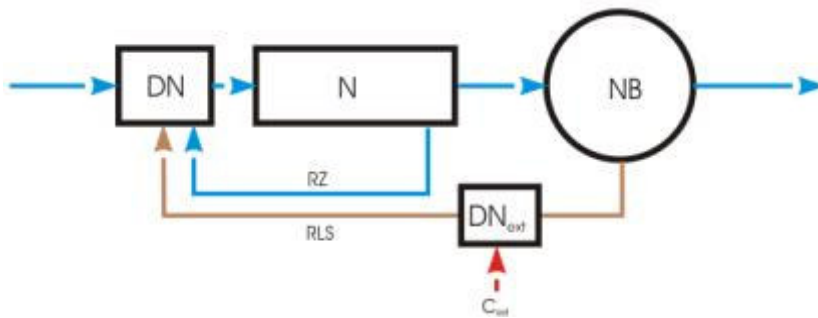

Fig. 49: Only the denitrification of the return sludge with external C

### Milieu Conditions

The denitrification is affected by several different parameters. Besides the kind of the substrate, resp. its disposability for the microorganisms, you should take into account the milieu conditions. The essential parameters are the concentration of the solute oxygen, the temperature and the pH.

### Oxygen Concentration

An increasing oxygen concentration slows down the denitrification. In the literature you can find contradicting information concerning the dimension of the obstruction. Generally one can assume that the oxygen concentration of 0,2-0,5 mg/l is tolerable. As the oxygen solubility is strongly affected by the temperature, it was suggested that one should rate the obstruction according to the relative saturation /55/. According to Metcalf & Eddy /56/ simplified linear connections between oxygen concentration and denitrification are specified. So with the concentration of 0,5 mg/l the denitrification level is only 50% and with 1 mg/l it goes towards zero. The most of the other authors go by the assumption of a non-linear connection, what also relates better in congruence with the general kinetics of biological processes. The impact of the concentration of the solute oxygen is represented according to the different information sources by the illustration /17,50,52/ .

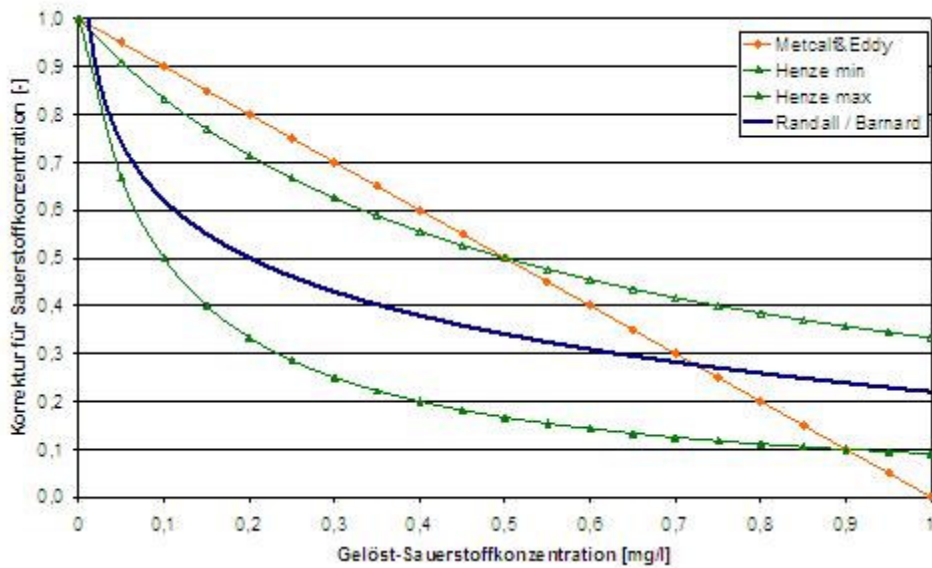

Fig. 50: Correction for the solute oxygen

For calculations in AQUA DESIGNER it is assumed, that the level of the solute oxygen concentration is so low, that the denitrification is not affected. If you want to take the impact of the solute oxygen into account, you can change the speed of the denitrification.

### Temperature

As a matter of principle the impact of the temperature on the denitrification level is also dependent on the kind of the substrate. But according to the previous experiments a differentiation makes no sense. The correction factor for the temperature is represented according to the different information sources by the illustration /17, 52, 53, 54, 2/ .

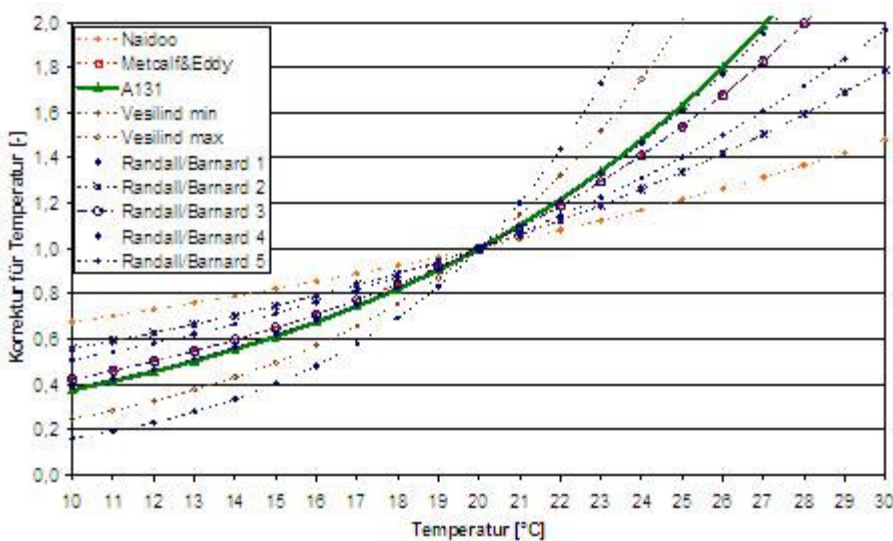

Fig. 51: Correction of temperature

## PH-Value

Also the impact of pH is dependent on the substrate. If the sludge is well adapted, the impact is normally less. The optimal level for the denitrification is approximately pH 7-8. The impact is represented according to the different information sources by the illustration /53, 54, 50/.

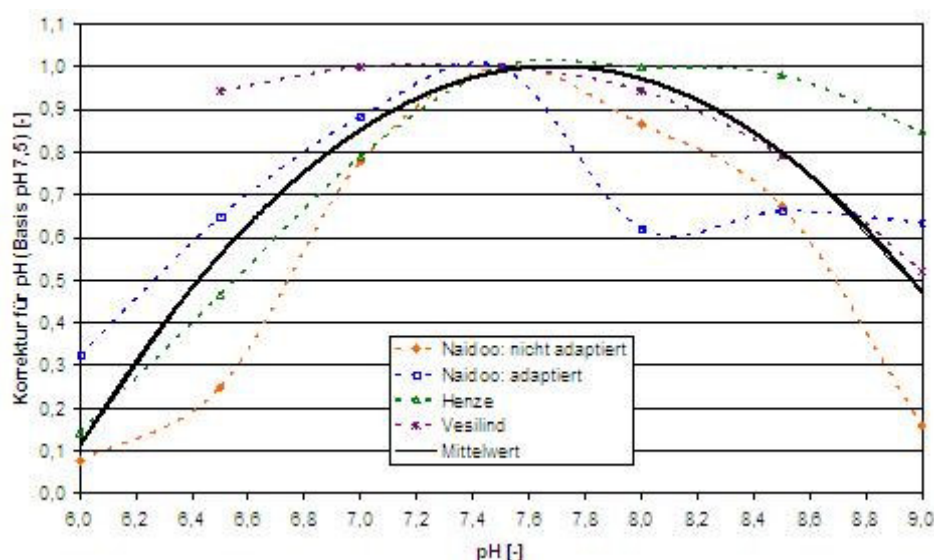

Fig. 52: Correction of pH

## Calculation

If the denitrification proportion resulted from an unfavourable CSB/N-Proportion is larger than 0,6, you get the clue.

Message: The denitrification proportion is larger than 0,6. Choose the external C-dosage to calculate this load case.

AQUA DESIGNER performs no calculations according to A 131E in this case.

In order to avoid high denitrification proportions, substrates with high percentage of carbon can be added. To find out the required quantity and the impact on the calculation, choose the selection box **external carbon**.

**A 131 Grunddaten**

**Bemessungsansatz**  
 A 131  Hochschulgruppe  Schlammstabilisierung

**Reinigungsanforderung**  
 Denitrifikation

**Organische Belastung**  
 Max. TS-Belastungsbecken 3,78 kg/m3  
 TS im Belebungsbecken (< 5 kg/m<sup>2</sup>)  kg/m3

Säurekapazität im Zulauf  mmol/l  
 TKN im Zulauf 55,92 mg/l  
 Ammonium-N im Ablauf  mg/l  
 Nitrat-N im Ablauf

**Phosphatelimination**  
 chemisch  biologisch  
 Faktor XP,BM

**Externe Kohlenstoffdosierung**  
 Externe Kohlenstoffdosierung  
 Zitronensäure

Dichte	1240	kg/m <sup>3</sup>
CSB-Konzentration	900,00	kg/m <sup>3</sup>
Denitrifikationskapazität	0,20	kgN/kgCSB
Denitrifikationsgeschwindigkeit	3,0	g/(kg*h)
Zusätzliche ÜS-Produktion	0,50	kg/kgCSB
Max. Denitrifikationsverhältnis	0,60	

**Ergebnis**  
 Erforderliches Volumen VBBmin 7.496,10 m3  
 Schlammalter, gesamt 18,25 d  
 Denitrifikationsverhältnis 0,600  
 Spezifische Überschussschlammproduktion 0,427 kg/kg

**Phosphatelimination**  
 XP,BM 1,93 mg/l  
 biologisch entnommen 0,00 mg/l  
 chemisch entnommen 0,00 mg/l  
 P-gesamt im Ablauf 7,58 mg/l  
 Anaerobvolumen 0,00 m3

**Ergebnis Phosphatfällung**  
 Überschussschlammproduktion 0,00 kg/d  
 Anteil am TS-Belastung 0,00 kg/m3  
 Fällmittelverbrauch nach Auslegung 0,00 l/d

**Ergebnis externe Kohlenstoffdosierung**  
 Zu denitrifizierendes Nitrat 42,71 mg/l  
 Denitrifizierbares Nitrat 39,60 mg/l  
 CCSB,dos 40,70 mg/l  
 Menge Dosiermittel 433,14 l/d

x 0,99

Berechnen  OK Abbrechen

Fig. 53: External C-Dosage

A window to specify the basics for carbon infliction would appear. Different dosage means would be provided in a panel. The material characteristics are taken from the AQUA DESIGNER data base and would be here presented.

**Calculation basics**

The proportion of denitrificated nitrate to carbon determines the denitrification proportion. This interrelation for simultaneous and intermittent denitrification is stated in A 131E.

In Worksheet DWA A 131 [/2/](#) the material characteristics of the most important dosing means are stated.

Parameter	Unit	Methanol	Ethanol	Acetic acid
Density	kg/m <sup>3</sup>	790	780	1060
COD	kg/kg	1,50	2,09	1,07
COD	g/l	1.185	1.630	1.135
Y <sub>COD,dos</sub>	g <sub>CODBM</sub> /g <sub>CODabb</sub>	0,45	0,42	0,42

Table 4 from /45/

About  $OV_{C,la,int}$  and  $OV_{C,la,vorg}$  the external carbon source is included to the calculation.

$$OV_{C,la,int} = f_{COD} * C_{COD,abb,ZB} * (1 - Y) + C_{COD,dos} * (1 - Y_{COD,dos}) \quad [mg/l]$$

$$OV_{C,la,int} = C_{COD,dos} * (1 - Y_{COD,dos}) \quad [mg/l]$$

In AQUA DESIGNER, the amount of dosing mean is increased until the maximum denitrification ratio of 0.6 is reached and maintained.

This is valid for the amount of dosage means

$$Q_{d,Dos} = \frac{S_{NO3,D,ext}}{\text{denitrification capacity}} * \frac{Q_d}{1000} \quad \left[ \frac{m^3}{d} \right]$$

## Precipitent

The list of dosage means, as well as their material characteristics are determined, resp. entered in the form **General Constants**. The common dosage means, such as methanol and acetic acids are supplied in the data base. You should go from the menu window to **Options > General Constants** and chose the register map **Precipitent**.

The screenshot shows the 'Precipitant' register map in the AQUA DESIGNER 9.2 software. The interface is organized into several functional areas:

- Dosing Chemical External C-Dosage:** A dropdown menu is set to 'Methanol'. Below it are input fields for:
  - Density: 790 kg/m<sup>3</sup>
  - COD-Concentration: 1185 kg/m<sup>3</sup>
  - Denitrification Capacity: 0,30 kgN/kgCSB
  - Denitrification Rate: 2,5 g/(kg<sup>3</sup>h)
  - Additional ES-Production: 0,50 kg/kgCSB
- Density Precipitant:** This section lists three types of precipitants with their respective properties:
  - Iron Salt FeCl3:** Dichte: 1,50 kg/l; Konzentration: 40,0 %
  - Aluminium Salt AlCl3:** Dichte: 1,50 kg/l; Konzentration: 40,0 %
  - Iron Salt FeSO4:** Dichte: 1,23 kg/l; Konzentration: 45,0 %
- Input Dosage Medium:** Three radio buttons are present:
  - Dosage before Activated Chamber
  - Dosage after Activated Chamber
  - Dosage in Return Sludge
- Additional Options:**
  - Dosage Volume acc. to DWA (0,2 kgN/kgCSB)
  - Additional ES-Production acc. to DWA (ATV) (0,5 kg/kgCSB)
  - Organic Part of MLSS acc. to ATV-M368
  - Organic Part of MLSS: 0,70

At the bottom of the window are four buttons: 'Reset', 'Save as standard', 'OK', and 'Cancel'.

Fig. 54: Register map Precipitant under Options > General Constants

The parameters in the register map **Precipitant** give a good picture on several important dimensioning parameters and process technology variants.

- Different dosage means would be provided in a panel. The dosage means are laid down in the AQUA DESIGNER data base. It is possible here to add new dosage means or adapt the available ones.
- The **DWA** gives recommendations for different parameters. These parameters are listed here. You can decide, if you use the value for the dosage mean, which is laid down, or the recommended by the **DWA**.
- The organic part of the activated sludge is calculated. If the information about the deviated organic part of the sludge is provided, it is possible to determine here the organic part.
- It is possible to integrate the dosage basin at different points of the vitalizing sludge circulation. Above in this chapter is shown, that this affects the putting on dry matter concentration and the material balances, which require to be checked.

The amount of the dosage means is determined based on the denitrification capacity. This is a material characteristic. You can edit this value in the form **Basic data** or in **General Constants**.

Further, it is possible to adopt the maximum denitrification proportion. So it is not only possible to assess till the maximum admissible denitrification proportion, you can specifically lay down a low denitrification proportion.

This is also possible without receiving the message about the maximum denitrification proportion. You can always co-opt an external C-Dosage in the dimensioning.

### 7.5.5 Simultaneous Aerobic Sludge Stabilization

Medium and small activation sludge plants are designed primarily with a sludge retention time, which leads to extensive mineralization of the activated sludge in the activation stage. For the simultaneous, aerobic sludge stabilization a high sludge age is specified.

Due to the high sludge age the plants are designed in large volumes. They are therefore insensitive to usual amounts of wastewater and concentration fluctuations. This leads to a high operating safety and process stability.

The resulting sludge is stabilized aerobically. It does not have to be further treated. For larger systems, however, a mechanical dewatering and if necessary a lime conditioning is required. Because of the long residence time, a substantial nitrogen removal can be achieved in the reactor despite low nutrient concentrations.

Sludge stabilization is available in the form **Parameter Activated Sludge Process**. Click on the control box for **Sludge Stabilization** in the **algorith-frame**. A sludge age can be preselected when sludge stabilization is chosen.

The sludge load, volumetric loading and the resulting required tank volume are computed after entering the sludge age and the MLSS-concentration in the inflow and in the activated sludge tank.

#### Sludge Age

A sludge age of 25 days is recommended for simultaneous sludge stabilization to guarantee the sludge stabilization at temperatures of 10°C as well. Several Operators, however, consider a sludge age of 20 days as satisfactory. In this case a partially incomplete sludge stabilization in the winter months is accepted.

#### Temperature Dependence

There is a temperature dependence of the required sludge age.

$$t_{TS, total} = 1,072^{(12-T)}$$

So for higher design temperature the required sludge age for simultaneous aerobic sludge stabilization will decrease.

For the extended interval for the temperature the calculation has been adapted according to the recommendations of "Themenband T4" /64/.

$$t_{TS} = \frac{f_B}{b_{H, 15^\circ C} * 1,072^{(T - 15)} * (1 - f_B - f_i)} \quad [d]$$

Inert part  $f_i = 0,20$

Decay coefficient for heterotrophic Biomass  $b_{H, 15^\circ C} = 0,17 \text{ d}^{-1}$

Stabilisation factor  $f_{B, Stab} = 0,62$

$f_i$  und  $f_{B, Stab}$  are standard values /64/ and can be adapted.



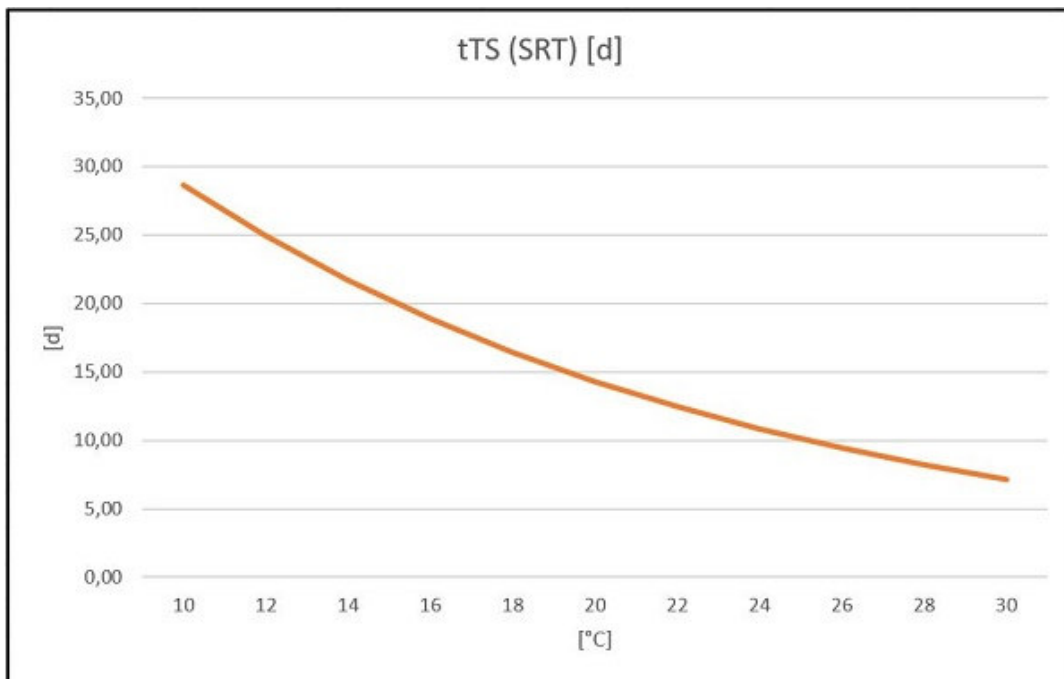

Fig. 55: Temperature dependence of sludge age for simultaneous aerobic sludge stabilization

Three different sludge ages are calculated when simultaneous aerobic sludge stabilization and a method for denitrification have been selected.

The minimum required aerobic sludge age is the minimum required sludge age at the selected dimensioning temperature for guaranteeing a stable nitrification.

The VN/V ratio is calculated for the preselected sludge age. From this the aerobic sludge age for sludge stabilization results.

After deciding on the activated sludge tank the actual sludge age is again calculated. The real aerobic sludge age results with VN/V.

### DWA A226

There is no verification of the sludge age in the computation based on the ATV A226 guideline. It is not possible to influence the dimensioning of biological processes by the sludge age.

## 7.6 Parameter Activated Sludge Process

In the computation form for **Parameter Activated Sludge Process** the data for the dimensioning of the activated sludge tank and the secondary sedimentation tank are entered. The dimensioning also includes the technical equipment for mixing and aeration. These components are designed in the form **Aeration**.

The cleaning operations denitrification and phosphate precipitation are optionally available. They can be added by check boxes.

Subsequently, the form **A 226 Parameter Activated Sludge Process** and the form **A131 Parameter Activated Sludge Process** are shown.

Fig. 56: Parameter Biology without selecting phosphorus removal (A 226)

### 7.6.1 Organic Load and Sludge Volume Index

In the worksheets A131 /2/ and A226 /58/ different specifications are given for the **organic load** in the influent of the activated sludge tank.

Depending on the organic load in the influent or the fraction of the organic industrial load, respectively, values for the sludge volume index (ISV) are preselected in both guidelines. These values can be adapted to individual requirements by the user.

The **sludge volume index** is a measure for the settleability of the activated sludge in the secondary sedimentation tank. The lower the ISV the better the settleability

and the smaller the volume requirements for the secondary sedimentation tank. In other words, the higher the load, the larger the dimensions for the secondary sedimentation tank.

#### Technical Information:

The Sludge Volume Index is a measure for the settleability of the activated sludge in the secondary sedimentation tank. It determines the volume of an unit of solid matter settling within a fixed time in a settling cylinder. Therefore, a high value for the sludge volume index means a delayed settling of the sludge.

A sludge volume index of 80 - 100 ml/g characterises a sludge with good settleability. For activated sludge plants with the common municipal influent, and aerobic sludge stabilisation a ISV of 100 ml/g can be postulated for the dimensioning.

High loads and high concentrations of biologically degradable organic substances in the influent cause a delay in settling or a higher sludge volume index, respectively. The upper limit for the required ISV is recommended by the A131 guideline (4.2.1 Anwendungsgrenzen und Abflußbeschaffenheit) as

ISV  $\leq$  180 ml/g.

Adding precipitants or flocculants in the form of iron or aluminium salts improves the settleability.

#### DWA-A131

About option fields load cases with low or high organic industrial content can be selected.

The sludge volume index (SVI) is presented depending on the load case and in accordance with the guidelines A 131.

Wastewater with	ISV ml/g
low organic load	75 - 100
high organic load	100 - 150

Table: SVI and influent conditions

#### DWA A226

A sludge volume index in the range from 100 – 150 ml/g is recommended.

### 7.6.2 MLSS-Concentration / Activated Sludge Tank

The volumes for the activated sludge tank and the secondary sedimentation tank

are greatly influenced by the mixed liquor suspended solids concentration (SS-concentration) in the activated sludge tank.

#### Technical Information:

The SS(MLSS)-Concentration demonstrates the correlation between the activated sludge tank and the secondary sedimentation tank:

To reduce the activated sludge tank volume it is possible to increase the  $SS_{AT}$ . However this results in a larger surface area for the secondary sedimentation tank (or additionally to a deeper secondary sedimentation tank in the A 131 /39/ respectively).

On the other hand a larger volume for the activated sludge tank must be selected if the secondary sedimentation tank has to be designed to be smaller.

The mixed liquor suspended solids concentration  $SS_{AT}$  value should not exceed 5 kg/m<sup>3</sup> in the activated sludge tank.

A mixed liquor suspended solids concentration  $SS_{AT}$  of < 2,5 kg/m<sup>3</sup> should be chosen in the event of a high sludge volume index, or when the sludge settles with difficulties (ATV A131, 4.1.3).

### DWA-A 131, 2016

After the input of the load data, the clarifier will be calculated. One of the results is the MLSS in the activated chamber. This value is recommended in the form "Parameter Biology".

### 7.6.3 MLSS-Concentration / Influent

The filterable solids or mixed liquor suspended solids in the inflow to the activated chamber are called  $S_{So}$  or  $X_{SS}$ . For wastewater treatment plants without primary sedimentation, values for raw waste water must be assumed.

$X_{TS}$  [mg/l]                      Concentration of filterable substances with a 0,45 µm membrane filter after drying at 105°C

### DWA-A131

The filterable substances in the influent of the activated sludge tank effect the sludge load and the sludge age.

The higher the SS concentration in the influent, the lower the sludge load. This results in a larger volume of the activated sludge tank with an increase of SS concentration in the influent.

An increase of SS concentration in the influent increases the excess sludge production and, therefore, the sludge age decreases.

The absolute load of mixed liquor suspended solids is calculated with the above specific value and the municipal population equivalent. No specific  $SSo$  value is suggested for trade or industrial wastewater inflow. The specific  $SSo$  value must be adapted for including industrial or trade wastewater when their  $SSo$  is known. Divide the total  $SSo$  load by the municipal PE to obtain the new specific value.

Enter this value in the field SSo, Inflow Biological Chamber.

## A226

The true MLSS-Concentration in the influent is not taken into account for the dimensioning of the wastewater plant based on the A226 guideline. Therefore no input field appears. Compared to the A131, a simplified calculation is used for calculating the sludge load. The sludge age is not required for the dimensioning.

## 7.6.4 Sludge Age and Excess Sludge

### Sludge Age A131

Sludge Age for Denitrification, see Nitrification and Denitrification 66

The dimensioning of the activated sludge tank, in accordance with the ATV A 131 /39/ guideline, is based on the sludge age in the AQUA DESIGNER Program.

Sludge load, volumetric loading and the required tank volume are calculated after choosing sludge age and TS-concentration in the influent and the activated sludge tank.

A sludge age of 25 d is recommended for the simultaneous aerobic sludge stabilisation method to secure a sludge stabilisation in temperatures of 10°C. Different operators, however, consider a sludge age of 20 d sufficient enough, occasionally accepting only partial stabilisation of the sludge during winter months.

Standard of Purification	Plant Layout	
	up to 20.000 PT	over 100.000 PT
Wastewater treatment with Nitrification, Denitrification and Sludge stabilisation	25	not recommended

Table: Sludge age from ATV A131, Table 2

### Sludge Age A226

Sludge age for simultaneous aerobic sludge stabilization and nitrification

$$t_{TS} \geq 20 \text{ d}$$

Sludge age for simultaneous aerobic sludge stabilization and denitrification

$$t_{TS} \geq 25 \text{ d}$$

MLSS, Biomass in the activated chamber

$$M_{TS,AT} = t_{TS} * WS_d \quad [kg]$$

Volume of the activated chamber

$$V_{AT} = \frac{M_{TS,AT}}{TS_{AT}} \quad [m^3]$$

For the calculation of the MLSS (TS<sub>AT</sub>) see the dimensioning of the secondary sedimentation.

### Biological Excess Sludge Production, A131, 2000

For the biological waste sludge production WS<sub>BOD</sub> :

$$WS_{d,C} = 0,75 + 0,6 * \frac{X_{SS,IAT}}{C_{BOD,IAT}} - \frac{(1-0,2)*0,17*0,75*t_{SS} * F_T}{1+0,17*t_{SS} * F_T} \quad \left[ \frac{kgTS}{kgBOD_3} \right]$$

### Biological Excess Sludge Production, Basis COD

$$X_{WS} = X_{inert,IAT} + X_{BM} + X_{inert,BM} \quad [mg/l]$$

$$X_{BM} = C_{deg} * Y - X_{BM} * t_{SS} * b * F_T \quad [mg/l]$$

$$X_{BM} = C_{deg} * Y * \frac{1}{1+b*t_{SS} * F_T} \quad \left[ \frac{mg}{l} \right]$$

Inert solids from endogeneous degradation:

$$X_{inert,BM} = 0,2 * X_{BM} * t_{SS} * b * F_T$$

$$WS_{d,C} = \frac{Q * \left( \frac{X_{WS}}{0,8 * 1,45} + X_{anorgSS,IAT} \right)}{1000} \quad \frac{kgSS}{d}$$

International:

F <sub>T</sub>	Temperature factor
t <sub>SS,min</sub>	Sludge age (Input value)
Y	Yield
b	Degradation coefficient
C <sub>deg</sub>	Biodegradable COD
X <sub>BM</sub>	COD-Konzentration of the biomass
X <sub>inert</sub>	Concentration of inert COD
X <sub>WS</sub>	Concentration of excess sludge as COD
X <sub>inert,IAT</sub>	Inert partikular COD (influent of the activated tank)

Deutsch:

F <sub>T</sub>	Temperaturabhängiger Faktor	-
t <sub>SS,min</sub>	Schlammalter (Eingabewert)	d
Y = 0,67	Ertragsfaktor	gCSB/gCSBabb
b = 0,17	Zerfallskoeffizient (T=15°C)	1/d
C <sub>deg,ZB</sub>	Abbaubarer CSB	mg/l
X <sub>BM</sub>	Als CSB gemessene Konzentration der Biomasse, bezogen auf Qt	mg/l
X <sub>inert,BM</sub>	Inerte Feststoffe aus endogenem Zerfall der Biomasse	mg/l
X <sub>ÜS</sub>	Als CSB gemessene Konzentration des Überschussschlammes	mg/l
X <sub>inert,ZB</sub>	Inerter Anteil des partikulären CSB	mg/l

The total excess sludge production ( $WS_B$ ) results from the biological excess sludge and the 'chemical' excess sludge from phosphorus precipitation. (see the Chapters 'Chemical Excess Sludge Production' and 'Total Excess Sludge Production').

### Biological Excess Sludge Production, A226

Total Excess Sludge

$$WS_d = WS_{d,C} + WS_{d,P} \text{ [kg/d]}$$

Excess Sludge from Carbon Degredation

$$WS_{d,C} = WS_{C,COD} * B_{d,COD} = 1,0 * B_{d,COD} \quad \text{[kg/d]}$$

Excess Sludge from Phosphate Elimination

Precipitant Iron  $FeCl_3$

$$WS_{d,P} = 0,1 * WS_{d,C}$$

Precipitant Aluminium  $AlCl_3$

$$WS_{d,P} = 0,08 * WS_{d,C}$$

## 7.6.5 Sludge and Volume Load

### DWA-A131

The **sludge load** results from the total waste sludge production ( $WS_B$ ) and the selected minimum sludge age ( $t_{SS,min}$ ):

$$B_{SS} = \frac{1}{WS_B * t_{SS,min}} \quad \left[ \frac{kg}{kg * d} \right]$$

The volume load ( $B_R$ ) results from the selected dry solids concentration in the activated sludge tank ( $SS_{AT}$ ) and from the sludge loading rate ( $B_{SS}$ ).

$$B_R = B_{SS} * SS_{AT} \quad \left[ \frac{kg}{m^3 * d} \right]$$

### A 226

In contrast to the A 131 /39/, the sludge load based on the A226 guideline results directly from the selected values for the volume load and the dry solids concentration:

$$B_{SS} = \frac{B_R}{SS_{AT}} \quad \left[ \frac{kg}{kg * d} \right]$$

Nitrification

$$B_{TS,BOD} \leq 0,05 \text{ [kg/(kg*d)]}$$

Nitrification/Denitrification

$$B_{TS,BOD} \leq 0,04 \text{ [kg/(kg*d)]}$$

The DWA demands a sludge load of 0,05 kg/(kg\*d). This requires a reduction of the volume load if the dry solids concentration for the activated sludge tank ( $SS_{AT}$ ) is selected lower. For example, selecting a  $SS_{AT}$  of 4 kg/m<sup>3</sup> for a volume load of 0,25 kg/(m<sup>3</sup>\*d) results in a sludge load of 0,063 kg/(kg\*d). This does not meet the requirements of the ATV. Selecting a  $SS_{AT}$  of 4 kg/m<sup>3</sup> the volume load should be maximum i.e. 0,2 kg/(m<sup>3</sup>\*d).

## 7.6.6 Activated Sludge Tank Volume Requirements

### DWA-A131

The required activated sludge tank volume is calculated after selecting the sludge age  $t_{TS}$ , the dry solids concentration in the activated sludge tank  $SS_{AT}$ , the dry solids concentration in the influent  $TSo$  and the standard of clarification.

The required activated sludge tank volume is:

$$V_{AT,min} = \frac{t_{SS} * WS_d}{SS_{AT}} \text{ [m}^3\text{]}$$

The required volume has to be carried out for the choice of the tank geometry. This is considered in the proposals for the diameter or the depth of the different tank designs. According to the choice of the tank dimensions, the actual volume is calculated and a proof of conformity with the minimal requirements is demonstrated.

### DWA-A 226

Sludge age for simultaneous aerobic sludge stabilization and nitrification

$$t_{TS} \geq 20 \text{ d}$$

Sludge age for simultaneous aerobic sludge stabilization with denitrification

$$t_{TS} \geq 25 \text{ d}$$

Required mass of solids in the aeration tank

$$M_{TS,AT} = t_{TS} * WS_d \text{ [kg]}$$

Volume of the aeration tank



$$V_{AT} = \frac{M_{TS,AT}}{TS_{AT}} \quad [m^3]$$

The calculation of TSBB see when calculating the secondary clarifier.

Required activated sludge tank volume

$$V_{AT} = \frac{EW_{BOD,60} * f_{AT}}{1000} \quad [m^3]$$

$f_{AT}$  is ejected as a result of the expression. Based on Tables 2 and 3 in the A 226/58 /, the value can be checked.

## 7.6.7 Return Sludge Ratio

### DWA-A131

The return sludge ratio (RS) is included to the dimensioning of the secondary sedimentation tank, more precisely in the calculation of individual altitude zones. The return sludge ratio is selected by the user and determines the ratio between the MLSS-concentration in the activated sludge tank and in the return sludge.

$$RS = \frac{SS_{AT}}{SS_{RS} - SS_{AT}}$$

The selection of a transport unit in the form **Return Sludge Transport** is based on the values entered to the form **Parameter Activation Sludge Process**.

The DWA report: „Anwendungshinweise zum ATV-Arbeitsblatt A 131–Teil Nachklärbecken“ /7/ advises return sludge ratio limits under different hydraulic conditions.

A maximum return sludge ratio of  $0.75 * Q_{stormwater}$  is advised for the dimensioning of secondary sedimentation and activated sludge tank in the selection of the horizontal flow secondary sedimentation tank. The machines for return sludge transport should be set for a capacity of  $1.0 * Q_{stormwater}$  for the operation.

A maximum ratio of  $1.0 * Q_{stormwater}$  for the dimensioning with the vertical flow sedimentation tank is recommended in the above mentioned report. The capacity of the transport machinery should cover  $1.5 * Q_{stormwater}$  for operation.

The ATV recommends  $Q_{dryweather}$  values as well. The basic value for the horizontal flow sedimentation tank is recommended as  $1.5 * Q_{dryweather}$ ; and for the vertical flow sedimentation tank a maximum return sludge ratio of  $2.0 * Q_{dryweather}$  is recommended.

AQUA DESIGNER reviews the input data and indicates when limiting values are exceeded. The Software also examines whether a selected return ratio for  $Q_m$  with combined wastewater inflow and stormwater is within limits for the dry weather condition as well. If this is not the case AQUA DESIGNER will point this out with a hint. In any case it is possible to continue the calculation with the selected values and conditions.

## A226

The return sludge ratio affects on the dimension of the secondary sedimentation by the MLSS concentration in the activated chamber.

The selection of the transport unit for the return sludge transportation is based on the return sludge ratio.

## 7.6.8 Nitrification

Sludge Age for Nitrification, see Only Nitrification 65.

The sludge age is sufficient for the nitrification process in activated sludge plants designed for aerobic sludge stabilisation. Therefore nitrification continuously takes place if satisfactory aeration is guaranteed.

The DWA guidelines demand a measuring/operating/ process design temperature of 12°C.

This value may be accessed and adapted in the list of details under **Options > Details**.

## 7.6.9 Denitrification

### DWA-A 131

The oxygen requirement and the aeration period are affected when **Denitrification is selected**. These values are later suggested in the window **Aeration**.

An input field **Nitrate-N in Effluent (Ne)** appears with a preselected value for the nitrate nitrogen in the effluent ( $\text{NO}_3\text{-N}$  mg/l). The same applies to the Ammonia-N in Effluent ( $\text{NH}_4\text{-N}$ )<sub>e</sub>.

From the nitrate nitrogen in the effluent the nitrogen load for denitrification is computed. The value for the nitrate-N is preselected as 3 mg/l, ammonia nitrogen in the effluent is selected as  $\text{NH}_4\text{-N} = 1$  mg/l.

**A 131 Parameter Belebungs**

Bemessungsansatz  
 A 131  Schlammstabilisierung

Reinigungsanforderung  
 Denitrifikation

Organische Belastung  
 Max. TS-Belastungsbecken 3,78 kg/m<sup>3</sup>  
 TS im Belebungsbecken (< 5 kg/m<sup>3</sup>) 3,78 kg/m<sup>3</sup>  
 Schlammalter t<sub>tsig</sub> 25,0 d

Säurekapazität im Zulauf 8,00 mmol/l  
 TKN im Zulauf 57,98 mg/l  
 Ammonium-N im Ablauf 0,00 mg/l  
 Nitrat-N im Ablauf 6,00 mg/l

Phosphatelimination  
 chemisch  biologisch  
 Faktor XP,BM 0,005

Externe Kohlenstoffdosierung  
 Externe Kohlenstoffdosierung  
 Primärschlamm

Dichte 1200 kg/m<sup>3</sup>  
 CSB-Konzentration 96,000 kg/m<sup>3</sup>  
 Denitrifikationskapazität 0,15 kgN/kgCSB  
 Denitrifikationsgeschwindigkeit 3,0 g/(kg<sup>h</sup>)  
 Zusätzliche ÜS-Produktion 0,50 kg/kgCSB  
 Max. Denitrifikationsverhältnis 0,60

Phosphatelimination  
 XP,BM 3,30 mg/l  
 biologisch entnommen 0,00 mg/l  
 chemisch entnommen 0,00 mg/l  
 P-gesamt im Ablauf 6,17 mg/l  
 Anaerobvolumen 0,00 m<sup>3</sup>

Denitrifikationsverfahren  
 Kaskade  
 vorgeschaltet  simultan  
 intermittierend  Kombiniert

Parameter  
 Inerter Anteil am partikulären CSB fA 0,25  
 Anteil der anorg. an den abfiltr. Stoffen fB 0,25  
 Anteil des leicht abbaubaren CSB fCSB 0,25  
 Ertragskoeffizient Y 0,67  
 Zerfallskoeffizient b 0,17

Prozessfaktor PF  

fN	1,4	1,6	1,8	2,0	2,2	2,4
SNH <sub>4</sub> , ÜV						
5 mg/l	<input type="checkbox"/>	<input checked="" type="checkbox"/>	<input type="checkbox"/>	<input type="checkbox"/>	<input type="checkbox"/>	<input type="checkbox"/>
10 mg/l	<input type="checkbox"/>	<input type="checkbox"/>	<input type="checkbox"/>	<input type="checkbox"/>	<input type="checkbox"/>	<input type="checkbox"/>

 Prozessfaktor gewährt PF 1,60

Fraktionen CSB  

Fraktion	Wert	Einheit
Partikulärer CSB	XCSB,ZB	450,16 mg/l
Gelöster CSB	SCSB,ZB	209,15 mg/l
Gelöster inerter CSB	SCSB, inert,ZB	32,97 mg/l
partikulärer inerter CSB	XCSB, inert,ZB	112,54 mg/l
abbaubarer CSB	CCSB, abb,ZB	513,80 mg/l
leicht abbaubarer CSB	CCSB, la,ZB	128,45 mg/l
abfiltrierbarer anorganischer CSB	Xanorg,TS,ZB	93,78 mg/l

Ergebnis  
 Erforderliches Volumen VBBmin 1.945,94 m<sup>3</sup>  
 Schlammalter, gesamt 25,00 d  
 Denitrifikationsverhältnis 0,396  
 Spezifische Überschussschlammproduktion 0,422 kg/kg

Ergebnis Phosphatfällung  
 Überschussschlammproduktion 0,00 kg/d  
 Anteil am TS-Belastung 0,00 kg/m<sup>3</sup>  
 Fällmittelverbrauch nach Auslegung 0,00 l/d

x = OVC,D / SNO<sub>3</sub>,D / 2,86 1,00

OK Abbrechen

Fig. 57: Basic Data based on ATV A131 with Denitrification

**Technical Information:**

Denitrification processes in the activated sludge tank result in different positive effects.

In the nitrification oxygen is used for the oxidation of ammonia to nitrate. In the denitrification part of the used oxygen is again utilised by the heterotrophic bacteria. This has a positive effect on the total oxygen requirements in the nitrogen removal process provided by aeration.

The operating costs for aeration are reduced with reduced oxygen requirements. However, it should be noted that lower oxygen requirements have to be transferred in a shorter time period with reduced aeration periods. This leads to higher investment costs for the aeration system which, however, generally does not invalidate the positive effect of the reduction in operating costs.

In the nitrification H<sup>+</sup>-ions are released. This reduces the buffer capacity of the wastewater. In the denitrification this process is partly reversed through binding of H<sup>+</sup>-ions. This has a positive effect on the pH value and, thus, the process stability.

Decisive for the success of the denitrification and biological phosphorus removal is the TKN/CSB-Ratio in the activated sludge tank influent. It is important to ensure that the complete BOD<sub>5</sub> of the influent is available for the above mentioned processes if the ratio is too large, ex. larger than 0,2. /13/ These cases should be computed without the primary sedimentation or with a shorter primary step respectively as in the here available processes. It should be noted that the intermittent denitrification is disadvantageous, as

carbon compounds are degraded in the aerobic phase that are not available in the anoxic phase.

You will find further information about denitrification in the part on aeration and oxygen requirement.

### DWA-A 226

In the calculation based on the guideline A226 /58/ no nitrate value in the effluent is required and thus, there is no nitrate nitrogen balance.

In contrast to the guideline A131 the choice of **Denitrification** has only an effect on the aeration period.

The aeration period is preselected with 16 h/d in the form **Aeration** as recommended in the A 226 /58/. During the 8 hour anoxic phase denitrification takes place.

The separate mixing and aeration option is preselected choosing denitrification.

#### **Technical Information:**

Mixing devices are required that maintain circulation during the denitrification period without aeration.

## 7.6.10 Phosphate Removal

### Generell

Further windows open within the form **parameter activated sludge process** when selecting the option phosphate removal.

Here you may select basic data for the biological and chemical phosphate removal or you may accept the preselected values.

You can choose biological and chemical phosphate removal independently of each other under A 131. This is for example advantageous, if no outlet value of 2 mg/l must be complied, therefore a chemical phosphate precipitation is not required. If you assume a higher biological phosphate intake from operating experiences, you can specify this and you will obtain an improved phosphate outlet value as result.

A 126 Basic Data

Organic Load

Low     High     High and Oscillating

Design Data

Sludge volume index (75-100 ml/g)     ml/g

MLSS (aeration tank) (<5 kg/m<sup>3</sup>)     kg/m<sup>3</sup>

BOD5-Volumetric loading (<0,25 kg/(m<sup>3</sup>\*d))     kg/(m<sup>3</sup>\*d)

Return Sludge Ratio   

Denitrification

Phosphate Elimination

Calculate

Phosphate Elimination

Basic Data

discharge Limit     mg/l

Biological P-Elimination

Dimensioning     %

Operation     %

$\beta$ -Value     h

Anaerobic contact time     h

Precipitant

Simultaneous Phosphate Elimination

Iron Salt FeCl<sub>3</sub>

Aluminium Salt AlCl<sub>3</sub>

Result

BOD5-Sludge Loading (<0,05)    0,050 kg/(kg\*d)

Spec. Excess Sludge Prod.    1,06 kgTS/kgBSB5

Result

waste sludge production    9,44 kg/d

Part of SS-Biological    0,30 kg/m<sup>3</sup>

Precipitant Consumption (Dimensioning)    18,23 l/d

Cancel    OK

Fig. 58: Basic Data based on ATV A 226 including phosphate removal

**Technical Information:**

The phosphate removal is mainly based on two processes.

Bacteria use phosphate compounds for their energy metabolism and cell growth. In addition some specific bacteria are capable of storing phosphates in the form of polyphosphates as their energy source. Bacteria accumulate in the activated sludge when favourable conditions in the operating process are met.

With the accumulation of these bacteria the fraction of incorporated phosphorus compounds increases. The phosphorus content of the activated sludge can increase from approx. 2 - 3 % up to 7 - 8 % by this enhanced phosphorus uptake.

The remaining phosphorus must be removed by chemical methods to meet the effluent limit for phosphorus. For example iron and aluminium salts are used for precipitation. Adding these precipitants causes an improvement of the settleability of the sludge. On the other hand, however, the effect on the wastewater buffer capacity is negative.

An effluent limit of 2 mg/l can be met during the summer months with solely biological phosphorus removal as operating experiences with one step activated sludge plants show.

The biological phosphorus removal is dependent on the wastewater contents, the sludge load and the selected clarification method. Intermittent denitrification is useful for the biological phosphorus removal with almost anaerobic conditions present towards the end of the Deni-phase. This stress situation favours bacteria with enhanced phosphorus uptake to accumulate in the activated sludge.

A high concentration of easily biodegradable organic compounds improves the

biological phosphorus removal.

The efficiency for the biological phosphorus removal reduces during the winter months in that a chemical precipitation should be considered for keeping the limit of 2 mg/l.

Metal salts are mainly used as precipitants. The solute metal ions together with the solute phosphorus compounds form an insoluble compound precipitating as flocs in the activated sludge.

The addition of metal ions has a negative effect on the wastewater buffer capacity as  $H^+$ -ions are released with the formation of the metal phosphate complex.

Formation of metal phosphate

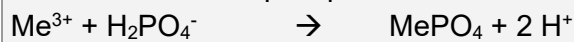

Formation of metal hydroxide

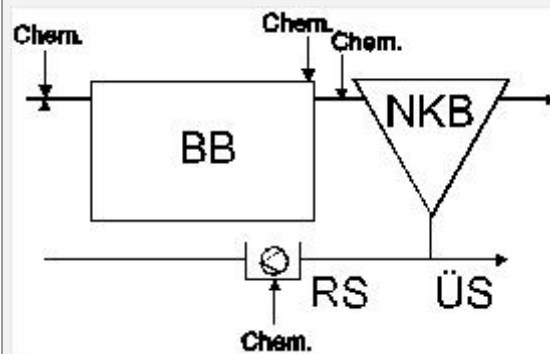
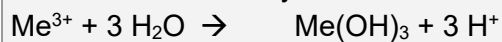

Fig. 59: Possible points of application in the simultaneous precipitation

## **Biological Removal**

Part of the phosphorus load in the influent is degraded by microorganisms. The theoretical basis is discussed earlier in the part of degradation of phosphorus compounds.

The fraction of the biologically removed phosphorus load from the total phosphorus load in the influent is preselected with different values in two input fields of the form **Parameter Activated Sludge Process**: The biologically removed fraction is selected lower for the precipitation than for the determination of the operation costs. This is on the one hand necessary to secure the phosphate precipitation in the winter period and on the other hand to only calculate with the average consumption for the operating cost.

The excess sludge from biological phosphorus removal can be disregarded for the A131 guideline:

$$WS_{P_{bio}} = 3 \frac{gTS}{g \text{ biologisch eliminiertes Phosphat}}$$

Only the part of the biologically taken phosphorus which is taken beyond the normal level, goes into the excess sludge production. The part for the cell production required is ca.  $0.005 \cdot C_{CSB,ZB}$ . The required anaerobic volume is determined according to the dimensioning instructions of the A 131. The minimal contact time is 0.5-0.75h, according to the incoming sludge and the return sludge.

### **Recommendations according to the A 131 for the degree of biological phosphate uptake:**

Without separate stage anaerobic basin or caewise return of the recirculation into the anaerobic basin

$$X_{P,BioP} = 0,005 * C_{COD,ZB}$$

With separate stage anaerobic basin

$$X_{P,BioP} = 0,01 - 0,0125 * C_{COD,ZB}$$

SNO<sub>3,AN</sub> ≥ 15 mg/l at low temperature degrees

$$X_{P,BioP} = 0,0075 - 0,01 * C_{COD,ZB}$$

Adaptation to the extended temperature range /64/

$$X_{P,bioP} = 0,014 * X_{BM} + 0,005 * X_{inert,ZB} + BM$$

This formula is used, if the design temperature is < 8 or > 20 °C.

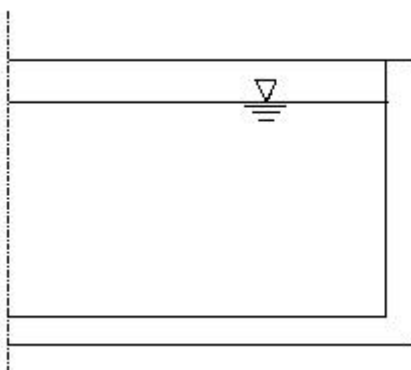

Fig. 60: Example: Phoredox-System

The required anaerobic volume is dimensioned in accordance to the recommendations given by Boll /1/. The suggested period of contact in the input field for **Anaerobic contact period** is related to the influent and the return sludge. Further information is available in the chapter on 'Theoretical Foundations'.

### Chemical Removal

The  $\beta$ -value is the molar ratio of the amount of added iron or aluminium ions exceeding the stoichiometrically required value. It represents the ATV A202 recommendations and its methods for elimination of phosphorus from the wastewater (DWA- A 202, Verfahren zur Elimination von Phosphor aus Abwasser).

From Table 1 of the DWA- A 202 guideline the most frequently used precipitants were selected that are aluminium chloride  $\text{AlCl}_3$  and iron(III)-chloride  $\text{FeCl}_3 \cdot 6\text{H}_2\text{O}$ . Both precipitants are presumed as 40-% solutions.

Chemical	Form of Supply	Effective Ion	Dosage for $\beta = 1,5$
$\text{AlCl}_3$	approx. 40-% Solution	$\text{Al}^{3+}$	65 mg/l $\text{AlCl}_3$
$\text{FeCl}_3 \cdot 6\text{H}_2\text{O}$	approx. 40-% Solution	$\text{Fe}^{3+}$	79 mg/l

Extract from Table 1: Precipitants; DWA- A 202

The method of choice is the simultaneous precipitation.. In this method the precipitant is directly added to the biological step. The point of application for the precipitant is the biological reactor or the return sludge pump station. An adequate mixing of the liquor with the precipitant is essential.

The Concentration of precipitant and the specific weight can be edited in **Options > General Constants** in the register **Sludge Treatment/Precipitants**.

### **Precipitant Requirement**

The precipitant requirement results from the molar ratio  $\beta$  for the addition and the



composition of the precipitant.

Ratio of the atomic masses of iron and phosphorus:

$$\frac{M_{\text{Fe}}}{M_{\text{P}}} = \frac{55,85}{30,97} = 1,8$$

$$\frac{M_{\text{Al}}}{M_{\text{P}}} = \frac{27,00}{30,97} = 0,87$$

$M_{\text{Fe}}$  Atomic mass iron [g/mol]

$M_{\text{Al}}$  Atomic mass aluminium [g/mol]

The added metal mass results for  $\beta = 1,5$  to:

$$\frac{M}{M_{\text{P}}} * \beta = 2,7 \text{ gFe/gP for iron salt}$$

$$= 1,3 \text{ gAl/gP for aluminium salt}$$

## Chemical Waste Sludge Production

Additional excess sludge results from the phosphate precipitation and is included into the computation for the dimensioning of the activated sludge tank based on the A131 guideline. Depending on the nature of the precipitant different chemical excess sludge productions result.

For precipitation with iron salt:

$$WS_{\text{P}} = 6,8 * \frac{P_{\text{elim}}}{B_{\text{d},\text{BOD}_5}} \left[ \frac{\text{kgSS}}{\text{kgBOD}_5} \right]$$

For precipitation with aluminium salt:

$$WS_{\text{P}} = 5,3 * \frac{P_{\text{elim}}}{B_{\text{d},\text{BOD}_5}} \left[ \frac{\text{kgSS}}{\text{kgBOD}_5} \right]$$

$WS_{\text{P}}$  sludge production from chemical phosphorus removal kg/kg

$P_{\text{elim}}$  P-load for removal (elimination) [kg/d]

$B_{\text{d},\text{BOD}_5}$   $BOD_5$ -Influent [kg/d]

These values apply for a molar ratio of  $\beta = 1,5$ . In the event of higher molar ratios the excess sludge production is increased proportionally.

For precipitation with iron salt:

$$WS_{\text{P}} = 6,8 * \frac{P_{\text{elim}}}{B_{\text{d},\text{BOD}_5}} * \frac{\beta}{1,5} \left[ \frac{\text{kgSS}}{\text{kgBOD}_5} \right]$$

For precipitation with aluminium salt:

$$WS_P = 5,3 * \frac{P_{elim}}{B_{d,BOD_5}} * \frac{\beta}{1,5} \left[ \frac{kgSS}{kgBOD_5} \right]$$

Only the phosphate load resulting from the difference between influent and effluent phosphate load, that is also the biologically removed phosphorus load, is used for calculating the phosphate precipitation.

### 7.6.11 Total Waste Sludge Production

The total sludge production results from the sum of biological and chemical sludge production. Based on the DWA-A 131 /39/ guideline the excess sludge from the biological phosphorus removal can be disregarded.

Therefore it is:

$$WS_B = WS_{BOD_5} + WS_P \text{ [kg/kg]}$$

WSB	Total waste sludge production	kg/kg
WSBOD5	sludge production from biological phosphorus removal	kg/kg
WSP	sludge production from chemical phosphorus removal	kg/kg

#### DWA-A 131

According to the A131 guideline the phosphate precipitation affects the size of the activated sludge tank. The excess sludge production increases when the precipitation step is selected for the phosphorus removal. Thus, the sludge load is reduced and the dimensions of the activated sludge tank need to be increased.

The chemical fraction of the excess sludge is incorporated into the design of the sludge treatment and the sludge container as well.

#### DWA-A 226

Extended surplus sludge production for phosphate precipitation

Precipitation with Fe

$$WS_{d,P} = 0,1 * WS_{d,C}$$

Precipitation with Al

$$WS_{d,P} = 0,08 * WS_{d,C}$$

BITControl	AQUA DESIGNER 9.2 - Manual	Seite: <b>105</b> von 314
	7 Dimensioning	Version: <b>92-00</b>

## 7.7 University Algorhythm

In 1988 a work group was constituted that in following developed a dimensioning method as a basis for computation models. This dimensioning method resulted from the exchange of experience of 11 universities and since has been modified and adapted to practical experience. The University Algorhythm and the DWA guideline A131 fundamentally have the same basis.

The dimensioning approach was published in 1989. A supplement was published in 1993 when particularly some constant values were modified.

Additionally to the ATV dimensioning guidelines the university algorhythm is an important tool for the dimensioning of activated sludge waste water clarification systems. The university algorhythm offers the oppertunity to compute outflow values on the basis of kinetic laws. It therefore offers superior results.

The university algorhythm suggests differing partly lower volumes in certain conditions. Here a comparitive computation is useful for economic reasons.

The AQUA DESIGNER dimensioning is primarily based on the following publications:

- Dimensioning of nitrogen elimination in the wastewater plant 8/89 /19/
- Dimensioning of wastewater plants for nitrogen elimination, compare ATV A 131 /39/- HSG 2/91 /20/
- Dimensioning of activated sludge tanks based on the university algorhythm - HSG-Ansatz- 8/93 /21/

**A 131 Basic Data**

Basis of Calculation  
 A 131  Hochschulgruppe  Sludge stabilization

Calculate Values  
 Oscillation Factor  average outflow concentrations S 2,00

Organic Load  
 maximum dry solid of the activated sludge chamber 3,78 kg/m<sup>3</sup>  
 MLSS (aeration tank) (< 5 kg/m<sup>3</sup>) 3,78 kg/m<sup>3</sup>

Acid capacity in the inflow 8,00 mmol/l  
 Ammonia-N in the inflow 42,39 mg/l  
 Peak-discharge of Ammonia-N 10,00 mg/l  
 Ammonia-N in the outflow (middle) 2,00 mg/l  
 Nitrate-N in the outflow (average) 6,00 mg/l  
 N-anorg outflow (peak) 18,00 mg/l  
 N-anorg outflow (average) 10,00 mg/l

Phosphate Elimination  
 chemical  biological  
 Basic Data:  
 discharge Limit 2,0 mg/l  
 B-Value 1,5

Precipitant  
 Iron Salt FeCl<sub>3</sub>  Aluminium Salt AlCl<sub>3</sub>  
 Iron Salt FeSO<sub>4</sub>

External Carbon Dosage  
 External Carbon Dosage  
 Methanol  
 Density 790 kg/m<sup>3</sup>  
 COD-Concentration 1,185 kg/m<sup>3</sup>  
 Denitrification capacity 0,10 kgN/kgCSB  
 Denitrification Rate 2,5 g/(kg·h)  
 Additional ES-production 0,50 kg/kgCSB  
 max. denitrification relation 0,50

Calculate interim result

Result:  
 Minimum volume VBBmin 10.920,29 m<sup>3</sup>  
 Sludge age, total 11,80 d  
 BOD5-Sludge Loading (<0.05) 0,0727 kg/kg/d  
 Specific surplus sludge production 1,166 kg/kg

Result Phosphate Elimination:  
 waste sludge production 295,94 kg/d  
 Part of SS-Biological 0,28 kg/m<sup>3</sup>  
 Precipitant Consumption for Dimensioning 498,26 l/d

Cancel OK

Fig. 61: Primary data based on the university algorithm considering phosphate removal and without simultaneous aerobic sludge stabilization

### 7.7.1 Scope

The university algorithm is applicable for single and multistage wastewater plants with domestic wastewater or wastewater comparable to domestic wastewater.

Wastewater plants for limits of NH<sub>4</sub>-N lower than 3 mg/l can not be dimensioned.

The calculated nitrate outflow values are average operating values. Limits for the nitrate outflow concentrations can not be obtained from the university algorithm.

### 7.7.2 Variation of Method

The below listed variations of method may be selected from the menu bar with **Options > Process** for nitrogen removal. You may only select these methods from the Main Window level. You must begin the computation from the Basic Data form if a new method was selected.

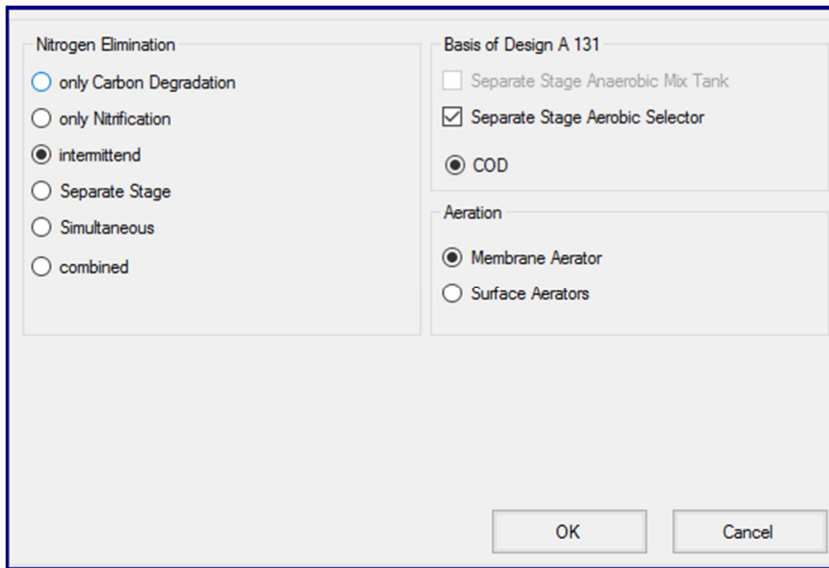

The screenshot shows a dialog box titled 'Nitrogen Elimination'. It has three main sections:

- Nitrogen Elimination:** Radio buttons for 'only Carbon Degradation', 'only Nitrification', 'intermittend' (selected), 'Separate Stage', 'Simultaneous', and 'combined'.
- Basis of Design A 131:** A checkbox for 'Separate Stage Anaerobic Mix Tank' (unchecked), a checked checkbox for 'Separate Stage Aerobic Selector', and a radio button for 'COD' (selected).
- Aeration:** Radio buttons for 'Membrane Aerator' (selected) and 'Surface Aerators'.

At the bottom right, there are 'OK' and 'Cancel' buttons.

Fig. 62: Selecting a method for nitrogen removal from the menu bar

## Nitrification

The aerobic sludge age equals the total sludge age when only nitrification was selected. The aeration period is suggested as 24 hours. The nitrate outflow concentration appears as result of the computation.

## Intermittant Denitrification

The daily aeration period equals the ratio of nitrification volume to total volume. As the actual aeration takes place over a shorter period it must be adapted accordingly and designed larger in the dimensioning. Mixing devices are required when selecting compressed air aeration to keep the activated sludge in suspension during the aeration free period and to obtain a satisfactory mixture.

## Combined Nitrification / Denitrification

The aeration period is suggested as 24 hours. The mixing devices are only dimensioned for the denitrification tank volume. One mixing device is suggested per line. More devices must be selected accordingly if multiple denitrification tanks are constructed in one line. The required recirculation energy will automatically be included in the calculation for the operation costs.

## Simultaneous Denitrification

The aeration period is 24 hours. Mixing devices are required for compressed air aeration to maintain the circulation and keep the activated sludge in suspension also in the non-aerated sections. There is no increased initial respiration in the simultaneous denitrification affecting the dimensioning. The factor of increased respiration is equal to 1.

### 7.7.3 Inflow

The inflow data were previously entered into the form for **Loads**. These data are processed in the dimensioning based on the A131 guideline as well as based on the university algorithm.

In addition to the data for the form on Loads the following data are entered into the Basic Data form:

TS <sub>0</sub>	filterable particles in the inflow	kg/PT/d
(NO <sub>3</sub> -N) <sub>0</sub>	Nitrate concentration in the inflow	mg/l

TS<sub>0</sub> is of great influence on the dimensioning and must be selected carefully. You will find the information on the TS<sub>0</sub> value ranges in the dimensioning guideline for the A131.

### 7.7.4 Outflow Requirements

The outflow limits for nitrogen and phosphate are entered into the Basic Data form. The dimensioning of nitrogen removal is based on its peak values and average values.

#### Preselected Values

Standard outflow values are preselected.

	control limits	daily peak value	daily average
Nanorg mg/l	18 I)	18	12
NH <sub>4</sub> -N mg/l	5 - 10 II)	5 - 10	1 - 2
NO <sub>3</sub> -N mg/l	-	-	10

I) ÜW Appendix 1

II) ÜW Appendix 1, 10 mg/l

The outflow concentration for organically bound nitrogen is 2 mg/l.

#### Calculated Values

Average outflow values may be calculated on the basis of the peak values. Click on the control box **Outflow Values** in the frame for **Calculate Values** to calculate the average values.

The input fields for the average outflow values will disappear as they are calculated.

NH<sub>4</sub>-N median value in dimensioning = NH<sub>4</sub>-N peak value in dimensioning / 5

NO<sub>3</sub>-N = N anorg.(ÜW) / 1,5 - NH<sub>4</sub>-N (median value in dimensioning)

## 7.7.5 Calculative Algorithm

### Aerobic Sludge Age

The daily fluctuation in the wastewater nitrogen load is considered in the dimensioning by including a fluctuation factor. The above listed literature demands that a fluctuation factor should whenever possible be calculated from data obtained through measurement. These data should be obtained through the period of at least one sludge age.

Fluctuation factor:

$$S = \frac{(N_{n,P} - [NH_4 - N]_{e,P}) * Q_P}{(N_{n,m} - [NH_4 - N]_{e,m}) * Q_{24}}$$

S	Fluctuation factor	
N <sub>n,P</sub>	Nitrifiable peak ammonia inlet	mg/l
N <sub>n,m</sub>	Average (middle) nitrifiable ammonia inlet	mg/l
Q <sub>P</sub>	Inflow according to nitrifiable nutrient concentration	m <sup>3</sup> /h
Q <sub>24</sub>	24-hours average inflow	m <sup>3</sup> /h

It is possible to calculate the fluctuation factor based on measurements when selecting the university algorithm computation in the **Basic Data** form.

Click on the control box for the **Fluctuation Factor** in the frame for **Calculate Values**. Input fields for nitrogen inflow peak values and correspondent wastewater volumes will appear.

The fluctuation factor is fixed in accordance with the university algorithm in the case of no available measurement data and no specified data entered into the program.

The following values are applied in the case of no available measurement data:

Population equivalent of < 20000 PT: S = 2,0

Population equivalent of >= 20000 PT: S = 1,7

The theoretical sludge age is calculated based on the work of Monod on ammonium outflow concentration and rate of growth of nitrate bacteria. The influence of temperature is considered by the use modifying temperature factors.

The safety factor f' comprises operating effects like partially insufficient oxygen concentration, fluctuating pH value or the effect of inhibiting factors on nitrate bacteria.

An adequate nitrification rate requires a minimum oxygen concentration of 0,5 mg/l in the overall nitrification volume. Therefore the aeration should be designed for 2 mgO<sub>2</sub>/l. This is considered in the dimensioning of the aeration system.

Theoretical aerobic sludge age requirement:

$$t_{SS,A} = \frac{f'}{\frac{\mu_{max}}{S} * \frac{[NH_4 - N]_{e,P}}{K_N + [NH_4 - N]_{e,P}} * f_{T,A} - b_A * f_{T,bA}} \quad [d]$$

f'	safety factor	-
f <sub>T,A</sub>	temperatur factor for autotrophic growth	-
f <sub>T,bA</sub>	temperatur factor for autotrophic die rate	-
K <sub>N</sub>	half life constant for N <sub>max</sub>	mg/l
b <sub>A</sub>	die rate of autotrophic organismen	1/d
μ <sub>max</sub>	growth rate	-

### Excess Sludge Production

The excess sludge production is of major importance for dimensioning the biological step. Different processes and conditions affect the activated sludge composition and the excess sludge production.

The filterable particles found in the wastewater plant inflow are of great influence on the excess sludge production. It is important to enter a realistic value. Approximate values based on Böhnke, B. und Pinnekamp, J. may be entered in the case of no available measurement data. These approximations are used in the A131 guideline as well.

Type of wastewater plant	Typical Value of So mg/l	Typical Value of TSo mg/l	TSo/So
Without primary treatment	300	360	1,2
With primary treatment	210	170	0,8
conv. 2-step	50	50	1,0
Adsorption-Step	150	50	0,33

Tab:Typical (Characteristic) values for So and Tso in the nitrification/denitrification step inflow depending on the primary treatment

### Biomass in the Activated Sludge

The autotrophic microorganism are responsible for nitrification. The fraction of autotrophic microorganism is primarily fixed by the aerobic sludge age.

Fraction of autotrophic microorganism:

$$x_A = \frac{y_A * (N_{n,m} - [NH_4 - N]_{e,m}) * qR * t_{SS,total}}{1 + b_A * f_{T,bA} * t_{SS,A}} \quad \left[ \frac{kgSS}{m^3} \right]$$

X <sub>A</sub>	Part of autotrophic organismen in actvated sludge	-
Y <sub>A</sub>	Yield of autotrophic biomass	mg/mg
N <sub>n,m</sub>	Average (middle) nificable ammonia inlet	mg/l
qR	Volume loading	m <sup>3</sup> /(m <sup>3</sup> *d)
b <sub>A</sub>	Die rate of autotrophic organismen	1/d



$f_{T,bA}$	Temperatur factor for autotrophic die rate	-
$t_{SS,A}$	Aerobic sludge age	d
$t_{SS,total}$	Total sludge age	d

The heterotrophic microorganism reduce the organic load and use the nitrate produced in nitrification for the nitrate respiration. Thus, they are responsible for denitrification.

Fraction of heterotrophic microorganism:

$$x_H = \frac{y_H * \eta * So' * qR * t_{SS,total}}{1 + b_H * f_{T,bH} * t_{SS,total}} \left[ \frac{kgSS}{m^3} \right]$$

$X_H$	part of heterotrophic organismen in actvated sludge	-
$Y_H$	yield of heterotrophic biomass	mg/mg
$\eta$	yield of BOD-degradation	-
$So'$	Inflow-BOD-concentration	mg/l
$f_{T,bH}$	temperature factor for heterotrophic die rate	-

The inactive fraction of the activated sludge is composed of the inflowing load of filterable particles and the fraction of dead heterotrophic and autotrophic biomass.

Fraction of inactive particles :

$$x_I = f_P * SSo * qR * t_{SS,total} + f_i * b_H * f_{T,bH} * x_H * t_{SS,total} + f_i * b_A * f_{t,bA} * x_A * t_{SS,A} \left[ \frac{kgSS}{m^3} \right]$$

$f_P$	Part of inert solids	-
-------	----------------------	---

Fraction of precipitation sludge:

$$x_F = (1,5 * P * Q + 1,9 * Fe + 2,9 * Al) * t_{SS,G} \left[ \frac{kgSS}{m^3} \right]$$

The phosphate precipitation increases the solids concentration in the activated sludge tank. AQUA DESIGNER always designs the activated sludge tank on the basis of the preselected solids concentration. In the case of phosphate precipitation the activated sludge  $x_H + x_A + x_I$  fraction is reduced in steps until the dry solids concentration in the activated sludge tank including the precipitation sediment equals the preselected dry solids concentration.

When 3,75 kg/m<sup>3</sup> was entered for MLSS in the activated sludge tank:

$$SS_{AT} = x_I + x_A + x_H + x_F = 3,75 \left[ \frac{kgSS}{m^3} \right]$$

The total excess sludge is the sum of the above described and produced fraction of the activated sludge divided by the sludge age. This results from the definition of

sludge age as the average detention time of the activated sludge.

Waste sludge production:

$$WS_R = \frac{x_H + x_A + x_I + x_F}{t_{SS,total}} \quad \left[ \frac{kgSS}{m^3 * d} \right]$$

## Buffer Capacity

The wastewater buffer capacity is reduced by different processes in the activated sludge tank. The effects of nitrification, denitrification and phosphate precipitation are discussed in detail in the chapter on the Theoretical Foundations.

The university algorithm defines the buffer capacity in the biological step outflow as follows.

Buffer capacity:

$$\begin{aligned} SKe = & SKo - 1/14 * NH_4 - No \\ & + \frac{1}{14} * (NH_4 - Ne + NO_3 - No - NO_3 - Ne) \\ & - 0,06 * Fe + 0,03 * Al + 0,03 * (Po - Pe) \quad \left[ \frac{mmol}{l} \right] \end{aligned}$$

SKo Buffer capacity in the biological step inflow

## Respiration Increasing Factor

The respiratory activity in the denitrification tank is increased in the event of pre-set/preliminary denitrification because of concentrated substrate feed. The intermittent denitrification is treated like the preset/preliminary denitrification in the ATV131 guideline. Here as well an increased respiratory activity is taken into account. In the simultaneous denitrification the respiratory elevation factor is  $a=1$ .

Pre stage (RF <10), intermittent denitrification:

$$a = 2,95 * \left( 100 * \frac{V_D}{V} \right)^{-0,235}$$

Simultaneous denitrification:

$$a = 1$$

## V<sub>N</sub>/V-Ratio Evaluation

The equations on the denitrifiable  $N_{d,m1}$  and the nitrogen to be denitrificated,  $N_{d,m2}$ , must result in the same sum to evaluate the V<sub>N</sub>/V-ratio.

The factor for increased respiration is incorporated into the equation for evaluating the oxidized nitrogen.

Denitrifiable nitrogen:

$$N_{d,m1} = a * \frac{f_D}{2,86} * \eta * S_o' * \frac{V_D}{V} * \left( 0,5 + \frac{0,24 * y_H * t_{SS,A} * A * \frac{V}{V_N} * f_{T,bH}}{1 + b_H * f_{T,bH} * t_{SS,A} * \frac{V}{V_N}} \right) \left[ \frac{mg}{l} \right]$$

$N_{d,m1}$	concentration of denitrifiable nitrogen	mg/l
$Y_H$	yield of heterotrophic biomass	mg/mg
$\eta$	yield of BOD-degradation	-
$S_o'$	inflow-BOD-Concentration	mg/l
$f_{T,bH}$	temperature factor for heterotrophic die rate	-

The fraction of incorporated nitrogen  $\dot{N}_{\dot{U}S}$  is included in the equation for evaluating the oxidized nitrogen. A factor for nitrogen return load is introduced as nitrogen from sludge storage and sludge treatment may return into the circulation with the turbid water. This factor  $rx$  has a standard value of 0 meaning that the nitrogen return load is primarily not considered.

The  $rx$  value may be adapted in the list of constant values under **Options > Constant Values HSG** if the nitrogen return load is to be considered.

Denitrificated nitrogen:

$$N_{d,m2} = TKNo,m + rx * \dot{N}_{\dot{U}S} + NFK - [NH_4 - N]_{e,m} - [NO_3 - N]_e - orgNe - \dot{N}_{\dot{U}S} \left[ \frac{mg}{l} \right]$$

$rx$	Fraction of nitrogen return load Standard value $rx = 0$	
$N_{d,m2}$	Concentration of denitrificated nitrogen	mg/l
$orgNe$	Organic nitrogen in the outflow Standard value $orgNe = 2$ mg/l	mg/l
$NFK$	Nitrogen from external sludge addition	

The  $NFK$  fraction ist not treated separately in AQUA DESIGNER. The external sludge may be entered in the industriell sludge fraction in the **Basic Data** form.

Incorporated nitrogen fraction of the activated sludge:

$$N_{WS} = \frac{i_B * x_H + i_B * x_A + ii * x_I}{t_{SS,G} * qR} \left[ \frac{mg}{l} \right]$$

## Volume Load

The required volume is calculated from the Volume Load and the daily wastewater inflow. First the constant P is calculated for evaluating the Volume Load.

$$\begin{aligned}
 P = & fp * TSo \\
 & + \frac{1 + fi * bH * f_{T,bH} * t_{SS,G}}{1 + bH * f_{T,bH} * t_{SS,G}} * yH * \eta * So \\
 & + \frac{1 + fi * bA * f_{T,bA} * t_{TS,A}}{1 + bA * f_{T,bA} * t_{TS,A}} * yA * (N_{n,m} - [NH4 - N]_{e,m}) \\
 & + 2,5 * Fe + 4,0 * Al \quad \left[ \frac{mg}{l} \right]
 \end{aligned}$$

$$qR = \frac{WSR}{P} \quad \left[ \frac{m^3}{m^3 * d} \right]$$

### 7.7.6 Constant Values

The listed constant values are an internal part of the university algorithm. They should not be changed without significant reason as consequently the calculations will not follow the recommendations of the university algorithm anymore.

Exeptions are the fraction of phosphate in the activated sludge ip and the fraction of the nitrogen return load rx.

The fraction of phosphate in the activated sludge can be selected up to ip = 0,08 when biological phosphate removal is assumed or operationally enhanced.

f'	1,25	
f <sub>D</sub>	0,75	
f <sub>i</sub>	0,20	
f <sub>T,A</sub>	1,103	
f <sub>T,bA</sub>	1,090	
f <sub>T,bH</sub>	1,073	
fp	0,60	
η	0,95	
rx	0,55	
bA	0,05	d-1
bH	0,17	d-1
iB	0,12	kgN/kgBio-mass
il	0,01	kgN/kgTS
ip	0,03	
K <sub>N</sub>	0,70	mg/l

$n_{\max,A}$	0,52	d-1
$Y_H$	0,75	
$Y_A$	0,15	
B	0,12	

## 7.8 MSIG

Basis ist he standard „Malaysian Sewerage Industry Guideline, Sewage Treatment Plants“ of the „National Water Services Commission von Malaysia“ /65/

Design tables give the guardrails for the design parameters. For continuous activated sludge systems it is distinguished between extended aeration (simultaneous aerobic sludge stabilization) and plants with anaerobic stabilization.

Description	Unit	Design Criteria
Primary Sedimentation System		Must be provided
Minimum number of aeration tanks		2
F/M ratio		0.25 - 0.50
Hydraulic retention time (HRT)	hrs	6 - 16 (for system where only ammonia removal is require) 12 - 16 (for plants require total nitrogen removal)
Oxygen requirements (for BOD and ammonia nitrogen removal)	kgO <sub>2</sub> /kg substrate	2.0
Mixed liquor suspended solids (MLSS)	mg/l	1500 - 3000 Typical: 2500
Dissolved oxygen (DO) level in tank	mg/l	1.0
Aeration device rating		Continuous, 24 hrs
Sludge yield	kg sludge produced/kg BOD <sub>5</sub> consumed	0.8 - 1.0
Sludge age #	day	5 - 10
Waste activated sludge, $Q_{WAS}$	m <sup>3</sup> /d	Refer to equation below †
Return activated sludge flow, $Q_{RAS}$	m <sup>3</sup> /d	$\frac{MLSS}{C_u \cdot MLSS} \times Q_{ws}$ C <sub>u</sub> is underflow concentration
$Q_{RAS} / Q_{INFLOW}$		0.75-1.0
Mixed liquor suspended solids recirculation for denitrification purpose		4 - 6 of $Q_{avg}$
RAS pump rating	hrs/day	24
Organic loading	kg BOD <sub>5</sub> /kg MLSS	0.25 - 0.5
Volumetric loading	kg BOD <sub>5</sub> /m <sup>3</sup> .d	0.3 - 0.6
Minimum mixing requirement	W/ m <sup>3</sup>	20

Fig. 63: Design parameter ASS with anaerobic stabilization

Description	Unit	Design Criteria
Minimum number of aeration tanks		2
F/M ratio		0.05 - 0.1
Hydraulic retention time (HRT)	hrs	18 - 24
Oxygen requirements(for BOD and ammonia nitrogen removal)	kgO <sub>2</sub> /kg <sub>substrate</sub>	2.0
Mixed liquor suspended solids (MLSS)	mg/ℓ	2500 - 5000 Typical: 3000
Dissolved oxygen (DO) level in tank	mg/ℓ	2.0
Sludge yield	kg sludge produced/kg BOD <sub>5</sub> consumed	0.4 (at 24 hrs HRT) 0.6 (at 18 hrs HRT)
Sludge age #	day	> 20
Waste activated sludge flow, Q <sub>WAS</sub>	m <sup>3</sup> /d	Refer to equation †
Return activated sludge flow, Q <sub>RAS</sub>	m <sup>3</sup> /d	$\frac{MLSS}{C_u - MLSS} \times Q_{avg}$ C <sub>u</sub> is underflow concentration
RAS pump rating	hours/day	24
Recirculation ratio, Q <sub>RAS</sub> /Q <sub>INFLOW</sub>		0.5 - 1.0
MLSS recycle ratio		4 - 6 times of Q <sub>avg</sub>
Volumetric loading	kg BOD <sub>5</sub> /m <sup>3</sup> .d	0.1 - 0.4
Minimum mixing requirement	W/m <sup>3</sup>	20
Tank dimension		
Water depth	m	3 - 5
Length:Width	ratio	3:1
Max width of joined tank	m	< 60

Fig. 64: Design parameter ASS with simultaneous aerobic sludge stabilization

## 7.9 Continuous Flowed Activated Sludge System

### 7.9.1 Upstream Anaerobic Chamber

The theoretical basis will be found at Chapter “Biological Phosphate Elimination”

#### Choosing a Chamber

It's possible to integrate the anaerobic volume into the volume of the activated chamber. This is useful for example together with the intermittent denitrification. The basics will be found in /10/. In an intermittent denitrification process you will have totally anaerobic conditions at the end of the denitrification phase. So you can extend the anaerated phase and add an anaerobic phase.

Choose **Options > Process** and in the frame **Basis of Design A131** the Option **Separate Stage Anaerobic Mix Tank**.

Fig. 65: Options > Process: Selection of an upflow anaerobic mix tank

In the **flow diagram** a new field **Anaerobic Mix Tank** will occur.

If you have chosen an anaerobic mix tank, in **Basic Data** the **Biological Phosphate Elimination** is presetted and cannot be deactivated.

**A 131 Basic Data**

Basis of Calculation  
 A 131    Hochschulgruppe    Sludge stabilization

Outflow Requirements  
 Denitrification

Organic Load  
 maximum dry solid of the activated sludge chamber 3,78 kg/m<sup>3</sup>  
 MLSS (aeration tank) (< 5 kg/m<sup>3</sup>)  kg/m<sup>3</sup>

Edit Oscillation Factor

Acid capacity in the inflow  mmol/l  
 Ammonia-N in the inflow 75,89 mg/l  
 Ammonia-N in the outflow  mg/l  
 Nitrate-N in the outflow  mg/l

Phosphate Elimination  
 chemical    biological

Basic Data  
 discharge Limit  mg/l  
 B-Value

Biological P-Elimination  
 Part of the biological fixed phosphorus  kgP/kgBSB5  
 Operation  %  
 Anaerobic contact time  h

Precipitant  
 Iron Salt FeCl3    Aluminium Salt AlCl3  
 Iron Salt FeSO4

External Carbon Dosage  
 External Carbon Dosage

Density  kg/m<sup>3</sup>  
 COD-Concentration  kg/m<sup>3</sup>  
 Denitrification capacity  kgN/kgCSB  
 Denitrification Rate  g/(kg<sup>3</sup>h)  
 Additional ES-production  kg/kgCSB  
 max. denitrification relation

Calculate   interim result

Fig. 66: Biological P-elimination pre selected, in combination with upflow anaerobic chamber

### Design of the Chamber

By the A 131 /39/ the retention time is the parameter for the design of the anaerobic volume. It's recommended with 0.5 – 0.75 h. Please note that the retention time relates to inflow and return sludge flow.

The retention time is related to the average dry weather inflow and the return sludge flow.

$$V_{AC} = \frac{t_R}{Q_{dw} + Q_{RS}} \quad [m^3]$$

- VAB      Volume of the Anaerobic Chamber
- tR        Retention Time
- Qt        Qt,aM average dry weather inflow



Separate Stage Anaerobic Mix Tank

Form of the Tank

Round Tank  Rectangular Tank

Minimum Volume 473,04 m<sup>3</sup>

Chosen Height  m

Calculate

Round Tank

Minimum Diameter  m

Chosen Diameter  m

Calculate

Volume  m<sup>3</sup>

Options Cancel Mixing

Fig. 67: Design upstream anaerobic mix tank

Rectangular and circular chambers are available. Typical or suitable values are always presetted.

If you want to select more than one line, go to **Options** and enter the number of lines for the anaerobic chamber. Its also possible to define the mixing devices by pushing the button **Mixing**.

## 7.9.2 Upflow Aerobic Selector

In case to prevent the grow of filamentous bacteria it proved effectively to integrate an upflow aerobic selector as a high loaded fermenter before the activated chamber. The upflow high loaded reactor inhibits the growth of filamentous bacteria and so the growth of bulking sludge /31/.

In the selector air will be injected. This will however not effect to the aeration of the biological chamber. As the infected oxygen will be totally used up here, there will be no negativ effect to a following denitrification. As there is no definitely declaration whether the oxygen supported to the selector can be deducted from the oxygen demand in the activated chamber, the designer can decide this for himself in Aqua Designer.

### Variations of Aeration

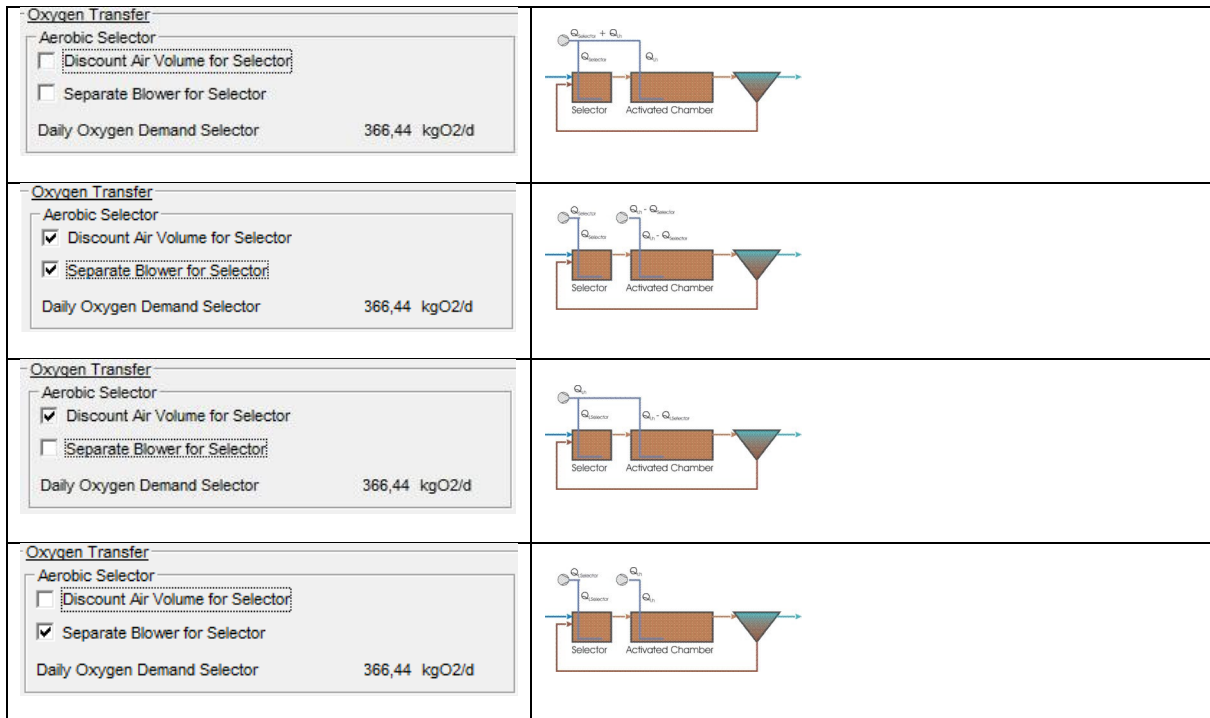

Fig. 68: Variations of the aration of selector and activated chamber

In AQUA DESIGNER you have all possible variants available to to consider the aer- ation of the selector. Therefore check boxes will occur in the aeration form for se- lecting the aeration of selector and activated chamber.

$Q_{L,h}$  is the Air Volume flow, resulting from the evaluation of the oxygen demand.

$Q_{L,Selector}$  will be calculated by  $4 \text{ kgO}_2/\text{m}^3$  as default.

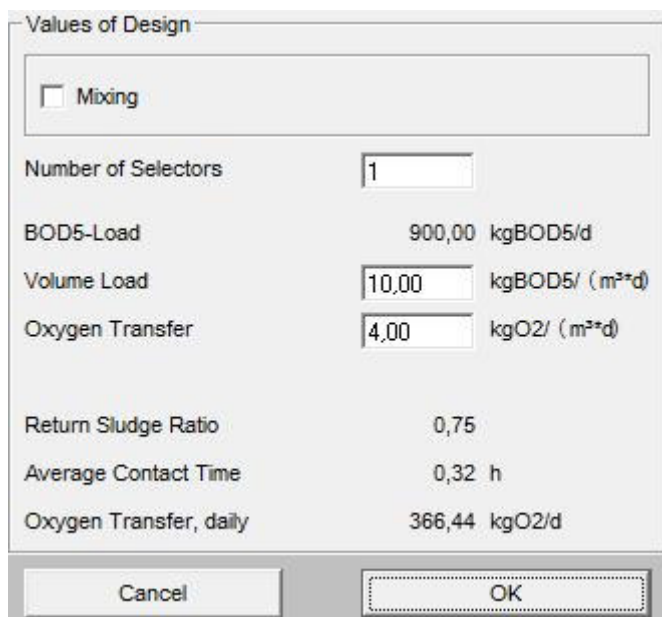

Fig. 69: Options Aerobic Selector

## Design Parameters

You can define the design parameters at the step **Aerobic Selector** under **Options**.

For nitrification and denitrification the volume of the aerobic selector can not be discounted from the volume of the activated chamber.

By designing only for carbon degradation, the volume of the aerobic selector can be discounted from the activated volume.

The basis for the design of the aerobic selector is the volumetric loading. The volume of the aerobic selector will be evaluated with

$$BR = 10 \quad \left[ \frac{kgBOD5}{m^3 * d} \right]$$

$$BR = 20 \quad \left[ \frac{kgCOD}{m^3 * d} \right]$$

BR Volumetric loading

The volume is:

$$V_{AS,BOD5} = \frac{B_{d;BOD5}}{10} \quad [m^3]$$

$$V_{AS,COD} = \frac{B_{d;COD}}{20} \quad [m^3]$$

The oxygen input should be:

$$\alpha OC = 4 \quad \left[ \frac{kgO_2}{m^3 Chamber\_Volume * d} \right]$$

## Mixing Device

To include the mixer for the selector, activate the check box **Mixing** in the form **Values of Design**. By leaving the active form **Values of Design** you will come back to the main formular for the selector. Now a button **Mixing** is visible.

Here you can select the mixer or a number of mixers out of the **Data Bank**.

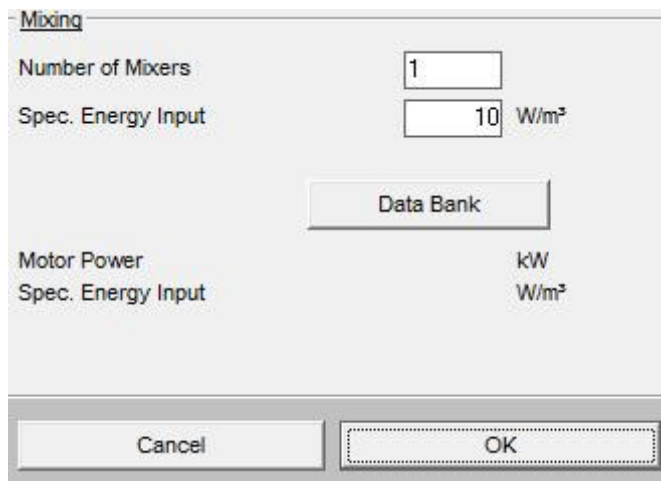

Fig. 70: Aerobic Selector with Mixers

If you have chosen more than one selectors, here the number of mixers means one chamber.

By clicking **OK** you come back to the flow diagram.

### 7.9.3 Secondary Sedimentation Tank

#### Design Variations

The particular advantage of AQUA DESIGNER is the opportunity of selecting a variety of different sedimentation chambers. You may select vertical or horizontal flow sedimentation chambers, hopper-bottom tanks and tanks with flat bottom, rectangular tanks or circular tanks. It is possible to calculate chambers in parallel and compare them while calculating. Through these features you are enabled to determine the most economical solution.

Several different designs for secondary sedimentation tanks are available to you.

ATV Guideline:	A 226 /58/ A 131
Methods:	horizontal flow vertical flow
Construction styles:	Chambers with flat bottom and slope (Plate remover or Sludge scrapers) Chambers with flat bottom without slope (Suction remover) Hopper-Bottom Tanks Circular Tanks Rectangular Tanks

The vertical flow or upward flow secondary sedimentation tank is available as hopper-bottom tank construction with the following advantages: Moveable mechanical equipment for sludge removal is not required, and there is a more effective

sedimentation than in the horizontal-flow tank with an even base.

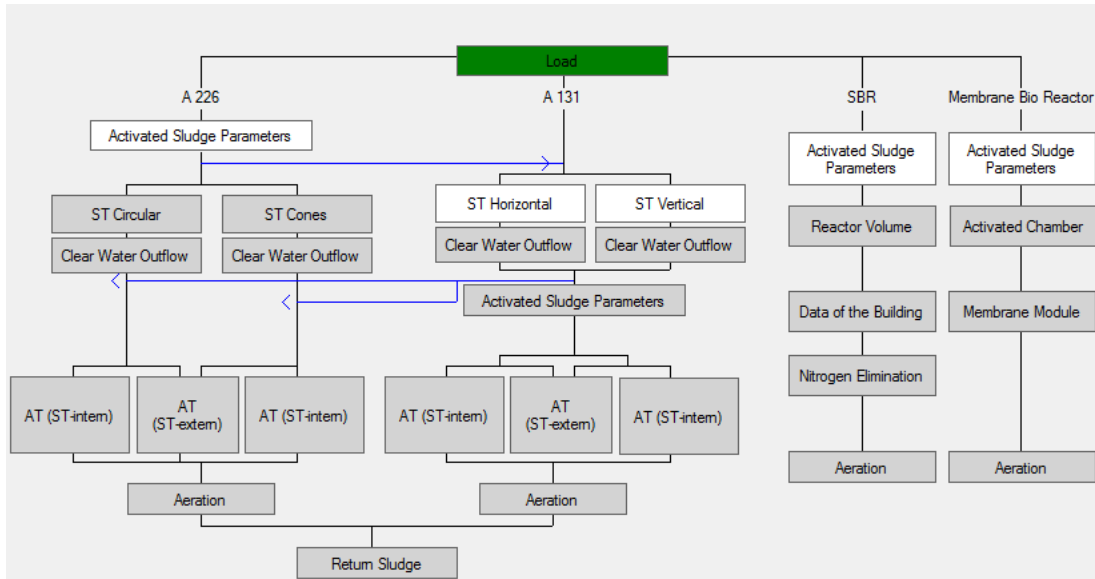

Fig. 71: Main Window with available choices for secondary sedimentation tanks

Depending on the conditions of the ground and ground water, however, hopper-bottom tanks are only constructed economically up to a limited hydraulic load.

Horizontal-flow tanks with sludge scrapers are used in the event of hydraulic loads that are above this limit.

### DWA-A 131

Both choices for secondary sedimentation tanks, the vertical- and horizontal-flow tank, can be calculated in parallel and can be evaluated in a comparing window. Chambers with flat bottom or hopper-bottom tanks can be calculated in the form for **SC vertical**. You can switch between these two options for comparison, while the results will be save.

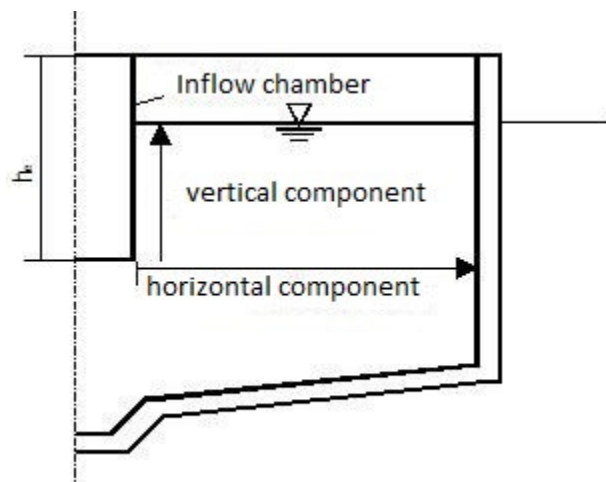

Fig. 72 Flow through a secondary clarifier

The type of flow of secondary clarifier is defined by the ratio of the vertical and horizontal flow path.

Horizontally flown:

$$\frac{\text{vertical component}}{\text{horizontal component}} < \frac{1}{3}$$

Vertically flown:

$$\frac{\text{vertical component}}{\text{horizontal component}} \geq \frac{1}{2}$$

The new A 131 indicates that intermediate values can be interpolated, that means you can choose for partial vertical flow a value of the sludge volume loading rate between 500 and 650 l/(m<sup>2</sup>\*h).

## DWA-A 226

Alternatively the guideline DWA A 226 /58/ allows the secondary sedimentation design based on the ATV A 131 /39/ guideline. Therefore selecting the dimensioning based on the ATV A 226 guideline, all available choices in the **Main Window** on the level for the secondary sedimentation are marked white after entering Parameter Activated Sludge Process. All choices of secondary sedimentation tanks can be calculated in parallel and compared in a comparative window.

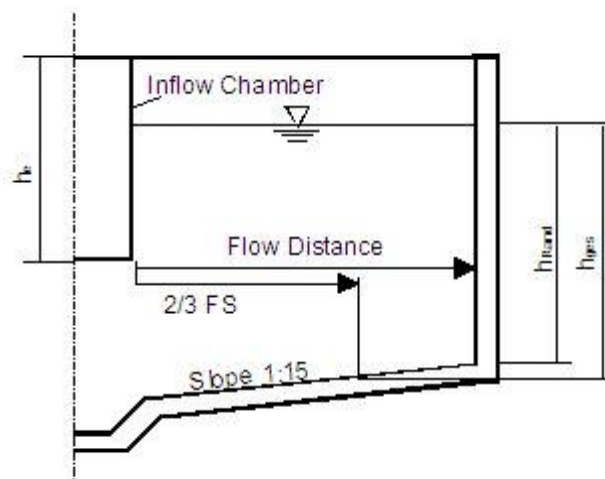

Fig. 73: Design of a secondary sedimentation tank / vertical flow

Vertical flow sedimentation tanks with flat bottom are considered as round tanks.

## Circular Chamber

### Vertical-Flow

Click on **NB vertical**. The form for computation of the vertical-flow sedimentation tank opens.

### Required Diameter

The surface loading rate ( $q_A$ ) is the most critical parameter for the dimensioning and computation of secondary sedimentation tanks. It results from the surface solids loading rate ( $q_{SV}$ ) and the already above mentioned parameters  $SS_{AT}$  and  $ISV$ .

### Detailed Information $q_{SV}$

$q_{SV}$  l/(m<sup>2</sup>xh)

Sludge volume surface loading or Sludge volume loading rate

### DWA-A 131

$$q_{sv} = 650 \frac{l}{m^2 * h}$$

for existing plants

$$q_{sv} = 500 \frac{l}{m^2 * h}$$

for new plants with circular chambers with flat bottom

This parameter indicates the amount of sludge in Liter, given to the surface of the sedimentation tank. The limit of this factor is set by experience.

The surface loading rate  $q_A$  (m/h) is the vertical velocity of the inflow in the chamber. Its to understand like a pipe.

$$q_A = \frac{Qm}{A} \left[ \frac{m}{h} \right]$$

The diluted sludge volume DSV is

$$DSV = SSEAT * SVI$$

So the DSV is the volume of the sludge l/m<sup>3</sup> in the inflow. For example for a DSV of 300 you will have 300 Liter of sludge in one Kubikmeter of wastewater-sludge inflow.

$q_A$  as the velocity in the tank is also

$$q_A = \frac{q_{SV}}{VSV}$$

So you can see, that  $q_A$  is the parameter for the total flow through the tank and  $q_{SV}$  is a parameter for the sludge compartment.

$$q_{SV} = q_A * V_{SV}$$

Using the volume current in the inlet ( $Q_m$  or  $Q_t$ ) the required surface area for the secondary sedimentation tank ( $A_{NB}$ ) is thus calculated with the following directions:

### Actual Diameter (A131, A226)

In the input field **Diameter, chosen** a rounded value for the secondary sedimentation tank diameter is suggested. Here the diameter of the inlet tank is already included.

A131 Secondary settling tank

Hopper tank     Tank with flat floor

Basic Data		Hopper tank	
Combined Inflow ( $Q_m$ )	90,10 m <sup>3</sup> /h	Minimum Volume	271,53 m <sup>3</sup>
$q_{SV}$ max	650 V/(m <sup>2</sup> ·h)	Minimum Diameter	8,55 m
Sludge volume index	<input type="text" value="100"/> ml/g	Diameter of inflow building, minimum	1,41 m
Return Sludge Ratio	<input type="text" value="0,47"/>	Chosen Diameter	<input type="text" value="8,60"/> m
Thickening time	<input type="text" value="2,00"/> h	Diameter of inflow building, chosen	<input type="text" value="1,41"/> m
dry solid(Return Sludge)/dry solid(tank bottom)	<input type="text" value="1,00"/>	Cone rectangle	<input type="text" value="60"/> °
<input type="button" value="Calculate"/>		<input type="button" value="Calculate"/>	
maximum dry solid of the activated sludge chamber	4,03 kg/m <sup>3</sup>	Height Total	9,38 m
Maximum surface flow rate	1,61 m/h	Height Cylinder	2,28 m
Minimum surface ( $q_{SV}$ max)	55,84 m <sup>2</sup>	Height Cone	7,10 m
		Surface without central feed	56,53 m <sup>2</sup>
		Volume	271,99 m <sup>3</sup>
		Height zones	
		Clear water zone	0,50 m
		Dividing zone	1,97 m
		Storage zone	1,02 m
		Thickening zone	5,89 m

Fig. 74: Vertical-flow secondary sedimentation tank

Accept this value with **Calculate**.

A vertical-flow secondary sedimentation tank may only be selected if the total depth of water does not exceed 15,0 m. Greater water depths are considered uneconomical.

You may select an angle between 60° and 80°.



## Horizontal-Flow

Click on **NB horizontal**.

The form for the computation of a horizontal-flow secondary sedimentation tank opens.

## Required Diameter

As with the vertical-flow secondary sedimentation tank the required tank diameter is calculated from the required surface area for the secondary sedimentation tank and the inlet chamber. The directions for the calculation are analogous as well. For the horizontal-flow secondary sedimentation tank, however, the surface solids loading rate is selected lower. It is:

## Actual Diameter

In the input field Diameter, chosen a rounded diameter is preselected.

The screenshot shows a dialog box titled "A226 Secondary Settling Tank". At the top, there are two radio buttons: "Round Tank" (selected) and "Rectangular Tank". Below this, the "Minimum Surface" is listed as 17,06 m<sup>2</sup>. A section titled "Round Tank" contains the following fields: "Minimum Diameter" (4,74 m), "Chosen Diameter" (input field with 4,80), and "Total Height (2/3 Flow Distance)" (input field with 6,40). A "Calculate" button is positioned below these fields. Below the "Calculate" button, the results are displayed: "Peripheral Height" (6,36 m), "Height at the Central Inflow" (6,49 m), and "Volume (without Inflow Building)" (113,61 m<sup>3</sup>). At the bottom of the dialog, there are three buttons: "Control Picture", "OK", and "Cancel".

Minimum Surface	17,06	m <sup>2</sup>
Minimum Diameter	4,74	m
Chosen Diameter	4,80	m
Total Height (2/3 Flow Distance)	6,40	m
Peripheral Height	6,36	m
Height at the Central Inflow	6,49	m
Volume (without Inflow Building)	113,61	m <sup>3</sup>

Fig. 75: A226 Secondary Settling Tank - Round Tank

## A131

The ATV A131 guideline recommends a vertical-flow sedimentation tank for secondary sedimentation tanks with a diameter of less than 20 m.

Note the calculation of the water depth by using a higher diameter than required.

## A 226

Secondary sedimentation for smaller plants are generally defined as vertical flow, because the relation of horizontal flow/vertical flow is lower than 0,5.

### Rectangular Chamber

In addition to a circular chamber, a rectangular chamber may be selected for the sedimentation chamber. The rectangular chamber is available as horizontal-flow tank in the A131 guidelines and at round tanks for the A 226 /58/. The required surface area for the chamber is displayed and a tank width is suggested in the AQUA DESIGNER.

The tank width may be changed in the input field **Width** in the window **Tank width**. (To the required length, resulting of the width and the surface, an inlet zone is added). A hint on how to dimension this inlet zone that is a zone of turbulence/disturbance is found in the A131 guideline, 4.2.6.1 on horizontal-flow chambers and rectangular chambers.

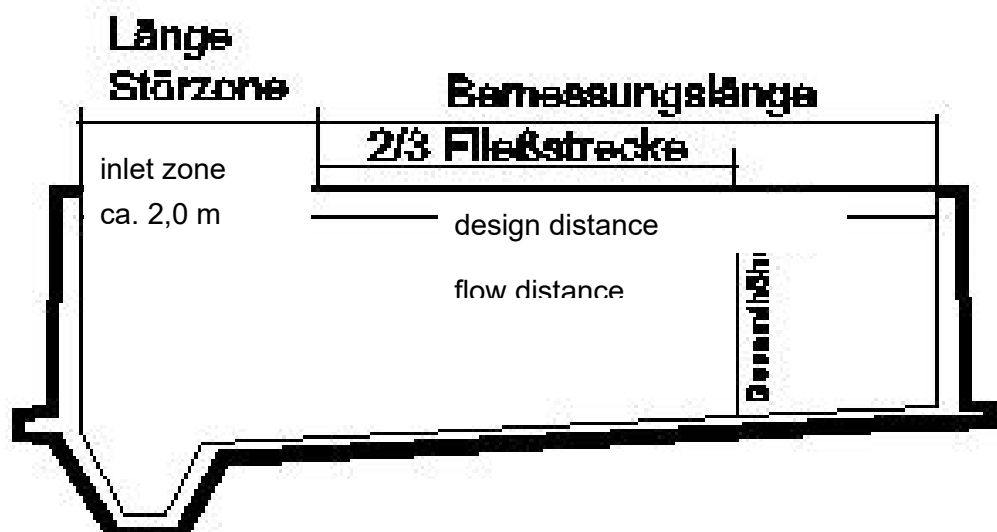

Fig. 76: Rectangular tank measurements (Length of zones)

The length of the inlet zone (turbulent inflow area) may be assumed as equal to the water depth. AQUA DESIGNER therefore suggests the water depth for the length of the inlet zone (turbulent inflow area). The value may be changed in the field for the **Length of the Inlet Zone**.

In the given total length this inlet zone (turbulent inflow area) is included.

To compare circular and rectangular chambers only change the options by clicking on the according option fields in the form **NB horizontal**. The results will be save. The active option is selected as the basis for the subsequent calculation.

## Inlet Chamber

From the inlet chamber the wastewater flows into the secondary sedimentation tank. The inlet should be designed to enable ventilation of the inflowing wastewater and activated sludge mixture.

### Diameter of Inlet Chamber

The diameter of all inlet chamber ( $D_D$ ) constructions - vertical, horizontal, A 226, A131 - is selected as 1/6 of the diameter that results from the required surface area for the secondary sedimentation tank:

$$D_D = \frac{1}{6} * \sqrt{\frac{4}{\pi} * A_{AT}}$$

### Inflow Level of Inlet Chamber

For the evaluation of the inflow level the different construction types and directions for computation need to be taken into account.

#### DWA A131

The inflow into the secondary sedimentation tank is located about 1,0 – 1,5 m over the bottom at the center /2/; page 45:

#### ATV A 226

The inflow level for **vertical-flow tanks** according to the A 226 guideline is calculated depending on the depth of the secondary sedimentation tank cylinder ( $h_z$ ):

$$h_e = 1,2 * h_z \quad [\text{m}]$$

The inflow level is not clearly determined for **horizontal-flow tanks** in the ATV guidelines. Here an inflow level of

$$h_e = 0,8 * \text{peripheral depth} \quad [\text{m}]$$

is assumed.

A sufficient retention time for flocculation has to be secured. Recommended is 60 s (DWA) to 180 s (Holthausen).

The G-value serves as a measure of the turbulent shear stress.

$$G = \sqrt{\frac{PE}{\mu * VE}} \quad [1/s]$$

G should be 40 – 80 s<sup>-1</sup>.

The power PE entered in the intake structure is calculated

$$PE = 0,5 * \rho_0 * v_E^2 * Q_M * (1+RV) \quad [\text{Nm/s}]$$

$v_E$  = entry speed into the inlet building

The inlet into the secondary sedimentation tank should be uniformly distributed over the circumference at a low speed. The entered energy is checked with the Froude number.

$$FD = \frac{u}{\sqrt{\frac{\rho_0 - \rho}{\rho} * g * h}}$$

The Froude number should be 1 resp. a little bit less than 1. The inlet gap height should be between 30 - 60 cm.

## **Chamber Depth**

### **DWA A131**

The evaluation of the liquid depth for secondary sedimentation tanks based on the A 131 /39/ guideline differs very much from the one based on the A 226. The secondary sedimentation tank for smaller wastewater plants is designed using the required surface area and minimal depth only. For the dimensioning according to the A131 the volume of individual zones in the secondary sedimentation tank is a significant dimensioning parameter.

### **A131 Horizontal-Flow**

The liquid depth consists of altogether four levels or liquid zones  $h_1$  to  $h_4$ . Distinct solid-liquid separation processes take place in these zones.

Clear Water Zone:

$$h_1 = 0,5 \text{ m}$$

Settling Zone:

$$h_2 = \frac{0,5 * qA * (1 + RS)}{1 - VSV / 1000} \quad [m]$$

Storage Zone:

BITControl	AQUA DESIGNER 9.2 - Manual	Seite: 131 von 314
	7 Dimensioning	Version: 92-00

$$h_3 = \frac{0,3 * TS_{AT} * ISV * 1,5 * qA * (1 + RV)}{500} \quad [m]$$

Thickening and Scraping Zone:

$$h_4 = \frac{TS_{AT} * qA * (1 + RV) * t_E}{TS_{BS}} \quad [m]$$

$$t_E = \left( \frac{TS_{BS} * ISV}{1000} \right)^3 \quad [h]$$

With the above determined algorithm we get the thickening time and the height of the thickening zone resulting from MLSS in the activated chamber and the return sludge ratio.

The return sludge process connects the activated sludge tank with the secondary sedimentation tank thickening and scraping zone. The user selected TS-concentration decisively influences the design of the secondary sedimentation tank.

The recirculation ratio and TS-concentration in the activated sludge tank determine the required solids concentration in the return sludge.

$$TS_{RS} = \frac{TS_{AT} + TS_{AT} * RV}{RV} \quad \left[ \frac{kg}{m^3} \right]$$

Short circuit currents need to be considered for removing the sludge from the sludge collecting hopper. Therefore a higher sludge concentration is needed at the tank base than is required for the return sludge.

For sludge scraper it is:

$$SS_{BS} = SS_{RS} / 0,8 \quad [kg/m^3]$$

Recommended 0,7 – 0,8

$SS_{BS}$       *TS-Concentration at the secondary sedimentation tank base*  
 $SS_{RS}$       *TS-Concentration of the return sludge*

For sludge withdrawal pipes (suction pipes) a coefficient of 0,5 - 0,7 is recommended. The AQUA DESIGNER suggests the factor 0,5. 0,7 is only intended for special constructions. You may change this factor in the form **Basic Data**.

The thickening detention period ( $t_E$ ) is:

$$t_E = \left( \frac{SS_{BS} * ISV}{1000} \right)^3 \quad [h]$$

$$C = 300 * t_E + 500 \quad [l/m^3]$$

## C Concentration depending on the sludge thickening detention period

With the presented algorithms the thickening detention period and in following the depth of the thickening and removal zone  $h_4$  result from the selected TS-concentration for the activated sludge tank and the recirculation ratio.

**Hint:**

A notice to your attention appears when the thickening detention period exceeds 2,0 hours. The A131 guideline indicates sludge buoyancy for thickening detention periods above 2,0 hours. The sludge buoyancy results from denitrification processes in the secondary sedimentation tank. It particularly occurs for uncompleted denitrification in the activated sludge tank.

The calculated total depth  $H_{NB}$  for the secondary sedimentation tank applies to 2/3 of the flow distance. The flow distance (FS) is the distance from the inlet chamber to the outlet of the secondary sedimentation tank.

Flow distance:

$$FS = \frac{D_{NB} - D_D}{2} \quad [m]$$

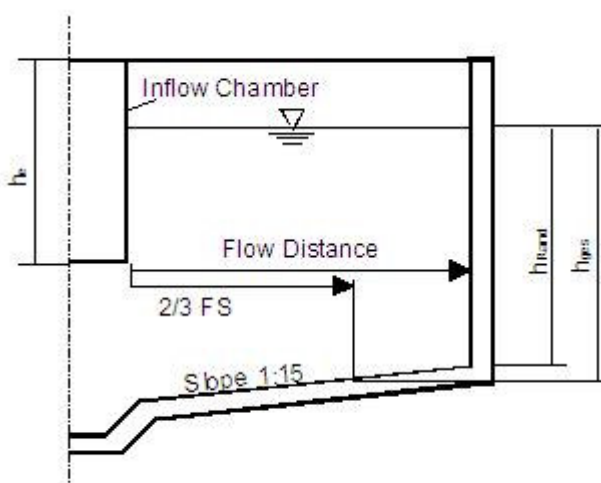

Fig. 77: Horizontal-Flow Secondary Sedimentation Tank

The tank bottom slope is empirically selected as 1:15. The height for the wall results from the slope and the total depth. You may change the slope value by accessing the **Details**.

Height of wall:

$$H_{NBper} = H_{NB} - \text{Slope} * FS/3 \quad [m]$$

A hint appears when the ATV based minimum heights are not ensured.

The ATV recommends a minimum height of 3,0 m for two third of the flow distance.  
The peripheral depth must not be lower than 2,5 m.  
The minimum height over the tank base at the central cylinder should be 4,0 m.

### Incorporating the True Diameter

In the form SC horizontal, a minimum diameter had been calculated and a real diameter was suggested. You may choose a larger diameter in the according input field. The chosen diameter will be incorporated into the calculation of the water depth.

The actual or real surface loading  $q_{A_{tats}}$  is calculated from the real diameter.

$$q_{A_{real}} = Q_m / A_{SC} \quad [m/h]$$

A new sludge volume loading results from  $q_{A_{real}}$  and the fixed values for the  $SS_{AT}$  /MLSS and ISB.

$$q_{sv_{tats}} = q_{A_{tats}} * SS_{AT} * ISV \quad \left[ \frac{l}{m^2 * h} \right]$$

The calculation of the required water depth is based on  $q_{A_{real}}$  and  $q_{sv_{real}}$ . You may choose a higher value for the water depth.

## A131 Vertical-Flow

### Flat Bottom

The calculation for the liquid level zones  $h_1$  to  $h_4$  is comparable to the calculation in the horizontal flow sedimentation tank using a sludge volume loading of 6500  $l/(m^2 * h)$  according to A131, 2000.

$$q_{sv} = 6500 \quad \left[ \frac{l}{m^2 * h} \right]$$

The concentration of the mixed liquor suspended solids MLSS is

$$SS_{RS} = 0,5 - 0,7 * TS_{BS} \quad [kg/m^3]$$

For the vertical flow sedimentation tank with flat bottom the real diameter  $q_{sv_{real}}$  is not used in the calculation of the water depth. Therefore a larger tank diameter does not affect a lower tank.

The sludge volume loading of  $q_{sv} = 600 \text{ } l/(m^2/h)$  is always in effect for the calculation of the vertical flow secondary sedimentation tank water depth.

Please see the following for evaluating the water depth in the hopper-bottom tank.

### Hopper-Bottom Tank

Initially a vertical-flow tank with flat base (cylindrical tank) is assumed for dimensioning the hopper-bottom tank. The calculation of the liquid level zones  $h_1$  to  $h_4$  is

carried out analogue to the horizontal-flow secondary sedimentation tank, however, using a sludge volume load of  $600 \text{ l}/(\text{m}^2 \cdot \text{h})$ .

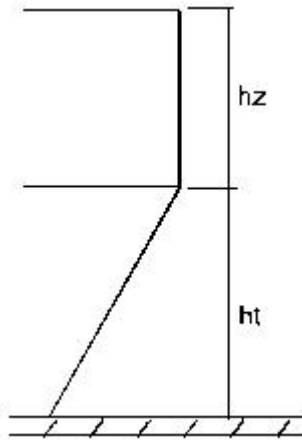

Fig. 78: Hopper Tank

The solids concentration in the return sludge is:

$$SS_{RS} = SS_{BS} \quad [\text{kg}/\text{m}^3]$$

The four liquid zone volumes are calculated using the already determined secondary sedimentation tank diameter and the heights  $h_i$ .

$$V_{i\_zyl} = \pi/4 * D_{NB}^2 * h_i \quad [\text{m}^3]$$

In following the volumes calculated for the cylindrical tank ( $V_{i\_zyl}$ ) are transferred on the hopper-bottom (circular) tank geometry.

The required liquid zone volume always results from the sum of  $V_{i\_zyl}$  and the volume fraction of the invert chamber in the particular zone:

$$\text{Clear Water Zone: } V_1 = V_{1\_zyl} + \pi/4 * D_D^2 * h_1$$

$$\text{Settling Zone: } V_2 = V_{2\_zyl} + \pi/4 * D_D^2 * h_2$$

$$\text{Storage Zone: } V_3 = V_{3\_zyl} + \pi/4 * D_D^2 * h_3/2$$

$$\text{Thickening Zone: } V_4 = V_{4\_zyl}$$

Please note that the invert is located in the center of the storage zone influencing  $h_1$ ,  $h_2$  and  $h_3$ . On the other hand the inflow depth is established by the heights as well. Therefore an iteration must be performed to evaluate the depths. The iteration steps are not demonstrated in detail at this point.

The clear water zone depth always is at least 0,5 m. This obligation is in effect as well when a lower depth results from a selected large diameter for a distinct required volume.

The computation for the vertical-flow secondary sedimentation tank is only possible



for a water depth up to 15,0 m.

The hopper bottom tank with the selected geometry - hopper angle and diameter are specified - is basically filled with the particular volumes  $V_i$  from bottom to top. The transition from the hopper to the cylindrical component is located at the side where the selected diameter is met. A minimum depth of 0,5 m is preselected for the cylinder.

The total depth of the hopper-bottom secondary sedimentation tank results from this.

The secondary sedimentation tank depth is variable by changing the diameter, see hint.

The **proof** for the tank design is demonstrated by comparing the required and the actual total volume:

$$V_{NB} = \frac{P_i}{4} * D_{NB}^2 * H_{NBper} + \frac{P_i}{12} * D_{NB}^2 * H_{Cone} - A_D * h_e \quad [m]$$

#### Example

The water depth is variable by changing the diameter.

In the liquid level calculation the cylindrical part begins when the selected diameter is reached. The cylindrical part shifts upwards when increasing the secondary sedimentation tank diameter in the input field diameter, chosen. A lower secondary sedimentation tank with larger diameter on top would result for the same volume. A minimum depth of 0,5 m for the cylindrical part is always guaranteed.

### DWA-A 226 Round Tank

A total depth of  $\geq 4,0$  m must be guaranteed for circular tanks with sludge scraper. This total depth applies to 2/3 of the flow section. The water depth at the secondary sedimentation tank wall  $h_{min}$  must never be less than 3,5 m.

The minimum total depth demanded by the ATV A 226 is preselected for the input field **Total Depth**.

A warning appears when a lower water depth is selected.

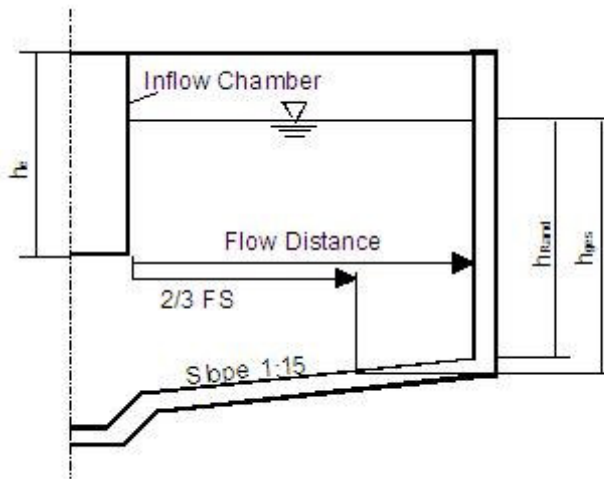

Fig. 79: Horizontal-Flow Secondary Sedimentation Tank

### A 226 Hopper Tank

The design surface is defined at the inflow level.

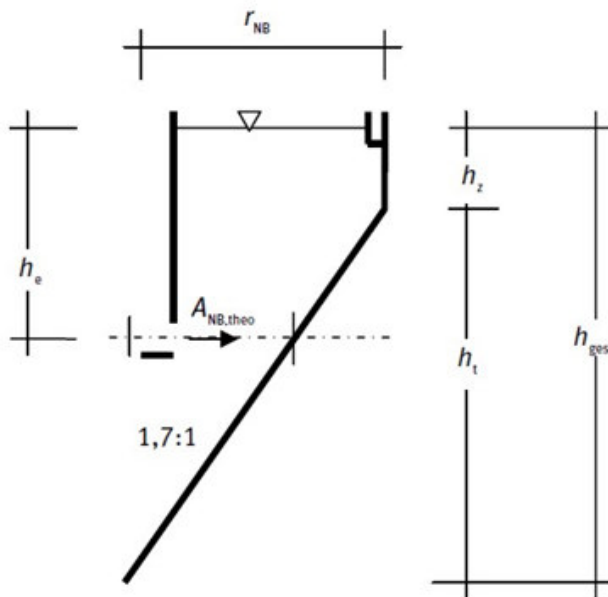

Fig. 80: Hopper Tank, A226

$$A_{NB,theo} = \frac{Q_{bem}}{q_A} \quad [m^2]$$

The inflow level depends on the total height:

$$h_e = h_{ges} * 0,3 \quad [m]$$

$$h_z \leq 1 \quad [m]$$

$$h_{ges} = \sqrt[3]{ANB, theo * h_{theo} * 3} \quad [m]$$

$$h_t = h_{ges} - h_z \quad [m]$$

$$h_e \approx h_{ges} * 0,3 \quad [m]$$

Required radius at the water level

$$r_{NB} = \frac{h_{ges} - h_z}{1,7} \quad [m]$$

The model for secondary sedimentations according to A226 is valid for

- Rain water systems  $Q_{bem} \leq \text{ca. } 100 \text{ m}^3/\text{h}$
- Municipal water system  $Q_{bem} \leq \text{ca. } 70 \text{ m}^3/\text{h}$

There are usually differences between  $h_{theo}$  and  $h_{ges}$  ( $h_{total}$ ), because the cone is cut and has a bottom diameter of about 0,40 m.

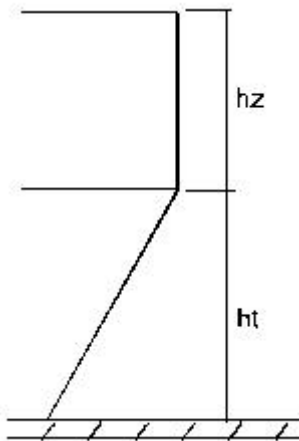

Fig. 81: Design of the Vertical-Flow Secondary Sedimentation Tank as hopper tank

A diameter of 0,4 m is selected for the hopper base when calculating volume and water depth.

The dimensioning of the vertical-flow secondary sedimentation tank is only valid up to a water depth of 15,0 m.

Choose a hopper angle in the input field **Hopper Angle**.

The tank with lowest possible slope results for 60°. Lower angles than 60° are not permitted for hopper-bottom (circular) tanks. Lower angles do not secure the sludge sliding spontaneously into the hopper base.

A maximum angle of 80° can be chosen.

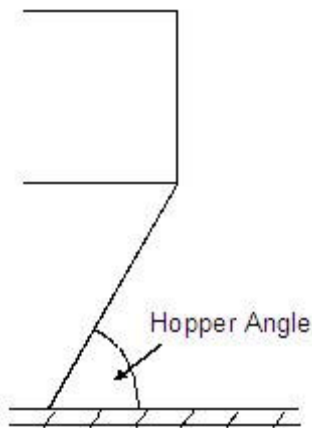

Fig. 82: Hopper Angle for Vertical-Flow Secondary Sedimentation Tanks

A lower angle than  $60^\circ$  can not be chosen as this does not secure the sludge sliding from the tank walls into the hopper. Special constructions should comply with this minimum angle in their angle of intersection.

### Partly vertical flown system

The limits for partly vertical flown and the interpolated  $q_{sv}$  are

$h_V/h_H \leq 0,33$  horizontal flown

$h_V/h_H \geq 0,50$  vertical flown

A relation of 0,33 for the flow means

$h_H = 12,0$  m

$h_V = 3,96$  m

If the chamber is deeper, the relation  $h_V/h_H$  will increase. The sludge volume load-  
ing can be chosen higher, so the surface area will be smaller.

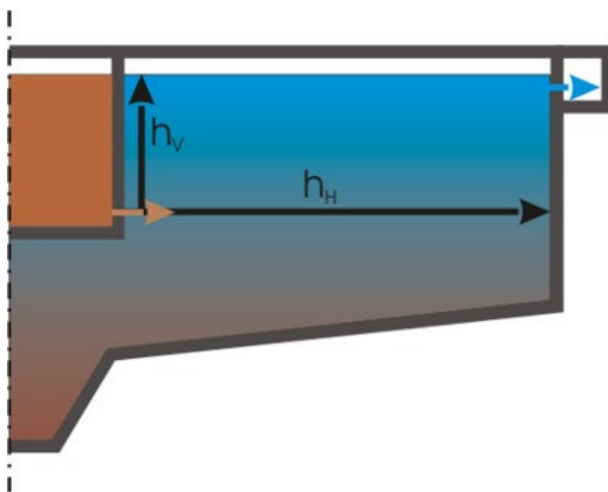

Fig. 83: Flow in the secondary sedimentation

Verhältnis*)	≥ 0,33	≥ 0,36	≥ 0,39	≥ 0,42	≥ 0,44	≥ 0,47	≥ 0,5
q <sub>SV</sub> (l/(m <sup>2</sup> ·h))	≤ 500	≤ 525	≤ 550	≤ 575	≤ 600	≤ 625	≤ 650
q <sub>A</sub> (m/h)	≤ 1,60	≤ 1,65	≤ 1,75	≤ 1,80	≤ 1,85	≤ 1,90	≤ 2,00
RV (–)	≤ 0,75	≤ 0,80	≤ 0,85	≤ 0,90	≤ 0,90	≤ 0,95	≤ 1,00

Fig. 84: (Table 11 DWA A 131) Permitted values for the transition zone from mainly horizontal to mainly vertical flow secondary sedimentations.

In the form for vertical flow sedimentations the relation hV/hH, the real sludge loading and the permitted sludge volumen loading is displayed. So you are flexible by creating the geometry of the chamber.

### **MSIG clarifier**

The design is based on the retention time.

Surface Overflow Rate SOR

$$SOR = \frac{Q_{peak} \left[ \frac{m^3}{d} \right]}{A [m^2]} \left[ \frac{m^3}{m^2 * d} \right]$$

Solids Loading Rate SLR

$$SLR = \frac{Q_{peak} \left[ \frac{m^3}{d} \right] * MLSS(BB) \left[ \frac{kg}{m^3} \right]}{A [m^2]} \left[ \frac{kg}{m^2 * d} \right]$$

Hydraulic Retention Time

$$HRT = \frac{V [m^3]}{Q_{peak} [m^3/h]} [h]$$

### **Metcalf & Eddy**

/56/ The valid parameters for the design of the clarifiers are Surface Overflow Rate, and Solids Loading Rate.

#### **Surface Overflow Rate**

$$SOR = \frac{Q [m^3/d]}{A [m^2]} \left[ \frac{m^3}{m^2 * d} \right]$$

SOR Surface Overflow Rate m<sup>3</sup>/m<sup>2</sup>/d

Q	Influent Flow Rate	m <sup>3</sup> /d
A	Clarifier Surface Area	m <sup>2</sup>

### Solids Loading Rate

$$SLR = \frac{(Q + QR) \left[ \frac{m^3}{h} \right] * MLSS [g/l]}{A [m^2] * 1000} \left[ \frac{kg}{m^2 \cdot h} \right]$$

SLR	Solids Loading Rate	kg TSS/m <sup>2</sup> /h
Q	Secondary System Influent Flowrate	m <sup>3</sup> /h
QR	Return Activated Sludge Flowrate	m <sup>3</sup> /h
MLSS	Mixed Liquor Suspended Solids concentration in flow entering the secondary clarifier	g/m <sup>3</sup>
A	Clarifier Surface Area	m <sup>2</sup>

### Side Water Depth

The side water depth should be 4,0 – 5,5 m.

## 7.9.4 Clarified Water Outlet

Two systems are available for the clarified water outlet.

**Outlet channels** are particularly suitable for small and medium sized horizontal-flow secondary sedimentation tanks.

**Immersed pipes** are recommended for vertical-flow secondary sedimentation tanks by the ATV.

In AQUA DESIGNER outlet channels may be selected for vertical- and horizontal-flow secondary sedimentation tanks. Immersed pipes are only available for vertical-flow secondary sedimentation tanks.

### Immersed Pipes

The outlet pipes located below the water surface are recommended by the ATV for hopper-bottom tanks or vertical-flow secondary sedimentation tanks respectively.

The immersed pipes are dimensioned for maximum flow velocity with maximum in-flow.

The following upper limits are effective:

	Velocity of Flow m/s
Perforations	0,25
Immersed Pipes	1,0
Outlet Pipe	1,0

The immersed pipes are radially arranged and are equally distributed over the surface. Their length results from the distance between the inlet and the secondary sedimentation tank wall.

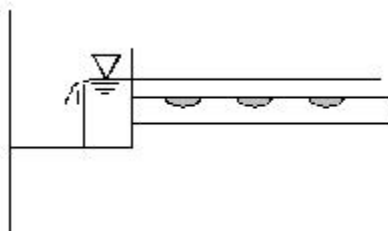

Fig. 85: Immersed Outlet Pipes

The required diameter of the immersed pipes is calculated from the number of pipes and the permitted flow velocity. A standard diameter is suggested from the result.

In the computation form for **Immersed Pipes** there is the possibility of varying the diameter of the perforations as well as the number of immersed pipes. Selecting a smaller diameter increases the number of perforations.

Selecting a large number of immersed pipes the required diameter decreases and at the same time the number of perforations per immersed pipe decreases.

Clear Water Outflow

Clear Water Weir  Submersed Pipes

Submersed Pipes

Length of each Pipe 4,02 m

Diameter of the Holes  mm

Number of Pipes

Number of Holes 41

Distance between the holes (>10 cm) 78,4 cm

Minimum Pipe Diameter 115 mm

Chosen Pipe Diameter

Fig. 86: Design of Immersed Pipes

## Overflow Weirs

The clarified wastewater leaves the tank via overflow weirs or outlet channels with preceding baffle walls respectively. An outlet channel fixed in 0,5 m distance from the secondary sedimentation tank wall is assumed. The weir loading is calculated from the maximum flow.

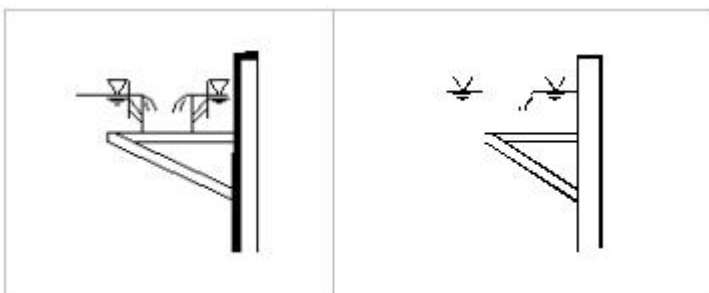

Fig. 87: Left: Double-sided overflow weirs; Right: Outlet Channel with preceding Baffle Wall

This is the only available clarified water outlet system for the horizontal-flow circular tank.

For the rectangular chamber overflow weirs may be designed with an overflow to one side or to two sides. The weir load is reduced by half when selecting the overflow to two sides.

### A 226

According to the DWA A 226 /58/ the weir load is not to exceed  $10 \text{ m}^3/(\text{m}\cdot\text{h})$ .

### DWA-A 131



BITControl	AQUA DESIGNER 9.2 - Manual	Seite: <b>143</b> von 314
	7 Dimensioning	Version: <b>92-00</b>

Based on the ATV A 131 /39/ guideline the weir load should whenever possible stay below  $10 \text{ m}^3/(\text{m} \cdot \text{h})$  for the single-sided overflow weir and below  $6 \text{ m}^3/(\text{m} \cdot \text{h})$  on both sides of the double-sided overflow weir. These values should be further reduced in the case of light sludge with a sludge index above  $150 \text{ ml/g}$ .

## 7.9.5 Activated Sludge Tank

### Generell

The activated sludge tank is computed in the form **Basic Data**. The computation steps for evaluating the required volumes are already demonstrated.

The actual tank geometry is determined in the form **Activated Sludge Tank**.

The proof of the selected design is demonstrated on this basis.

### Chamber Construction

Different types of tanks are available for the activated chamber.

The circular or rectangular tank can be selected for the separate construction of activated chamber and sedimentation chamber.

The compact construction system is available either as combined system or circular chamber with flat bottom or as compact system with central hopper-bottom tank.

The compact or separated construction is available for the sedimentation tanks of flat-bottom type or hopper bottom type with the activated chamber as circular or rectangular tank.

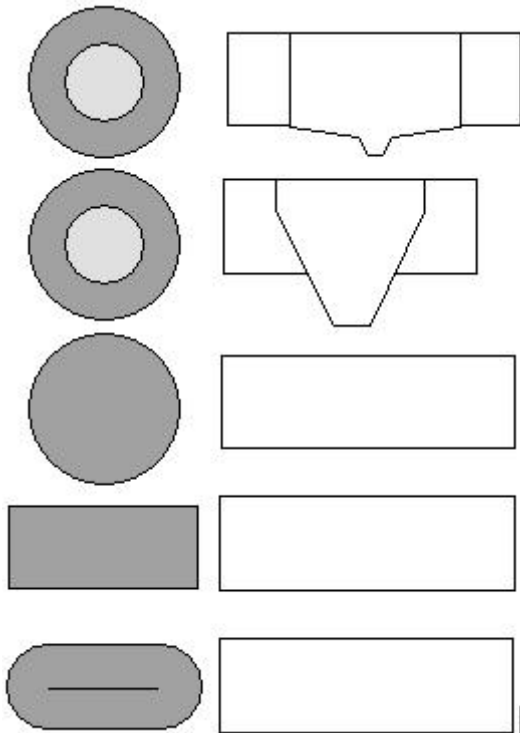

Fig. 88: Variation of chamber construction

Combined systems with central sedimentation with flat bottom

Compact system with central hopper tank

Separate Chamber as circular chamber

Separate chamber as rectangular chamber

Separate chamber as oxidation ditch

### Combined Tank System

In the computation form **AC (NB intern)** in the **Main Window NB horizontal** tree line a tank geometry for a circular tank with central horizontal-flow secondary sedimentation tank is computed. This type of tank is also called a package plant.

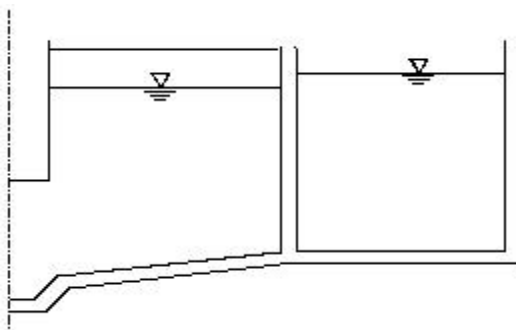

Fig. 89: Diagram of a package plant

The required activated sludge tank volume resulting from the computation in the form **Basic Data** is displayed.

## Diameter

The given required diameter is the overall diameter of the package plant. This diameter incorporates the inner secondary sedimentation tank wall with its thickness of 30 cm as shown in the form **Details**. No minimum distance is preselected between the activated sludge tank and the secondary sedimentation tank.

A 131 Activated Chamber	
dry solid in the activated sludge chamber	4,41 kg/m <sup>3</sup>
Minimum Volume	1047,66 m <sup>3</sup>
Volume load, maximum	0,346 kg/(m <sup>3</sup> *d)
Height	5,11 m
Diameter	19,44 m
Chosen Diameter	<input type="text" value="19,50"/> m
<input type="button" value="Calculate"/>	
Volume Activated Chamber	1057,08 m <sup>3</sup>

Fig. 90: Diagram of a package plant

In the input field **Diameter, selected** the given rounded value may be accepted or another value may be entered.

## Water Depth

The indicated depth is equal to the water depth and results from the package plant tank geometry.

The floor level of the activated sludge tank corresponds to the secondary sedimentation tank floor level at the rim. You will find this demonstrated in the above drawing of a package plant. Because of the hydraulic loss the height of the water level in the activated sludge tank is assumed 10 cm higher than the water level in the secondary sedimentation tank. This value can be changed in the form **Details**.

## Volume

The true activated sludge tank volume is calculated from the water depth and the value that was entered in the input field for **Diameter, selected**, thus, the dimensioning is verified.

True activated sludge tank volume:

$$V_{AT} = \text{Pi}/4 * H_{AT} * (D_{AT}^2 - (D_{ST} + 0,6)^2) \geq V_{AT,min}$$

$$H_{AT} = H_{NBper} + 0,1 \text{ (respective chosen level distance)}$$

H <sub>AT</sub>	Water Depth of Activated Sludge Tank	[m]
D <sub>AT</sub>	Outer free Diameter of the Activated Sludge Tank	[m]
D <sub>ST</sub>	Free Diameter of the Secondary Sed. Tank	[m]
H <sub>STper</sub>	Peripheral Water Depth of the Secondary Sed. Tank	[m]

A value of 0,3 m is taken into account for the thickness of the secondary sedimentation tank wall.

### **Compact Plant**

The secondary sedimentation tank is a hopper-bottom tank arranged as centre unit within the activated sludge tank

This tank construction is called a compact plant in following.

### **Water Depth**

The activated sludge tank water depth is selected by the user. The required diameter for the activated sludge tank is calculated from the selected water depth and the required volume.

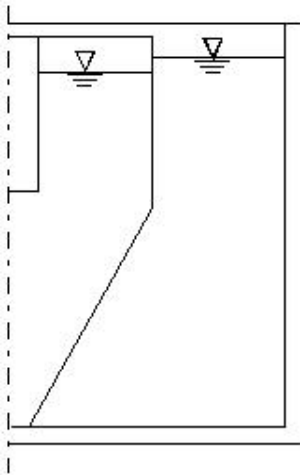

Fig. 91: Compact plant with even base, maximum water depth

A water level difference of 10 cm is taken into account between the activated sludge tank and the secondary sedimentation tank when the tank geometry is determined.

It is only possible to select a water depth smaller or equal to the water depth for a compact plant with even base.

Meaning, the maximum water depth in the activated sludge tank is 10 cm higher than the secondary sedimentation tank water depth.

In Figure 48 the base of the secondary sedimentation tank and the activated sludge tank are level. For deep secondary sedimentation tanks it is useful to design the activated sludge tank more flat. In this case a concrete placement funnel is introduced into the activated sludge tank base. In following the part of the secondary sedimentation tank above the tank base may be constructed out of metal (aluminium or stainless steel) or concrete. An according tank is displayed in the **Control Picture**.

Fig. 92: Form Compact plant

## Diameter

A minimum diameter is calculated for the activated sludge tank using the required volume and the selected water depth.

For compact plants with even base the tank volumes of the activated sludge process and secondary sedimentation are added and from the result the required activated sludge tank diameter is calculated. For tanks with deeper secondary sedimentation the volume below the tank base is deducted from the secondary sedimentation tank volume.

The difference between the diameters of the activated sludge tank and the secondary sedimentation tank should be at least 1,5 m.

*In Fig.52* a compact plant with centrally located vertical-flow secondary sedimentation tank is outlined. The hopper ends on one level with the base. The user is free to select a more even activated sludge tank. In this event the hopper base is lower than the base of the activated sludge tank. This is considered when calculating the volume.

**Technical Information:**

Circular tanks may be constructed economically as scaled chambers. The tanks offered by the construction companies are levelled in steps. The diameters should be selected in 0,5 m steps if this is to be considered in the design.

The total depth of the tank is levelled in 0,5 m steps as well whereas the remaining free board may be varied here.

**Volume**

The true volume of the activated sludge tank is calculated as follows:

$$V_{AT} = \pi/4 * H_{AT} * D_{AT}^2 - V_{ST} + V_U$$

$V_U$  is the volume of the secondary sedimentation tank located below the base of the activated sludge tank. The truncated cone is calculated according to the following equation:

$$V_U = \pi/12 * (H_{ST} - H_{AT}) * (D_{AT,Bottom}^2 + D_{AT,Bottom} * D_{ST,Bottom} + D_{ST,Bottom}^2)$$

If the secondary sedimentation tank cone ends level with the tank base the volume is  $V_U = 0$ . The thickness of the secondary sedimentation tank walls constructed of stainless steel or aluminium are neglectable.

The minimum volume calculated in the form **Basic Data** is displayed to allow direct comparison between required and actual volume.

The verification for the conduction of a correct dimensioning is carried out with the true activated sludge tank volume.

**Control Graph**

The selected geometry may be evaluated with a scaled drawing of the compact plant.

Click on **Control Picture**.

A scaled drawing with the measurements for the compact plant appears.

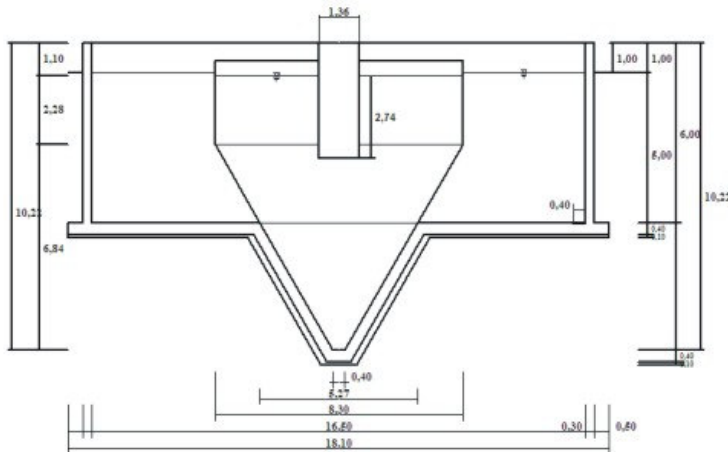

Fig. 93: Scaled Drawing with Measurements

**Conducting another calculation the Control Graph will automatically adapt and display the new measurements.**

### Separate Tanks

In the form for computing **AC (SC extern)** the tank geometry for a separate circular tank is computed.

Circular and rectangular chambers are available.

Rectangular chambers are particularly useful for larger plants. They can be more economic in the construction, for example, when multiple lines are selected. Also, several walls are eliminated when the rectangular tanks are directly joined.

On the other hand rectangular tanks will require thicker walls for static considerations.

The construction type is selected from the option fields for **Circular Tank** and **Rectangular Tank**.

Design a **rectangular chamber** by clicking on the according option button.

A 131 Activated Chamber

dry solid in the activated sludge chamb	3,78 kg/m <sup>3</sup>	<input type="radio"/> Round tank	<input checked="" type="radio"/> Rectangular tank
Minimum Volume	19540,38 m <sup>3</sup>	<input type="radio"/> plug flow reactor	
Volume load, maximum	0,154 kg/(m <sup>3</sup> *d)	Chosen Height	<input type="text" value="4,00"/> m

Rectangular tank

Width  m

Minimum length 116,31 m

Chosen length  m

Volume Activated Chamber  m<sup>3</sup>

Fig. 94: Rectangular Tank Design

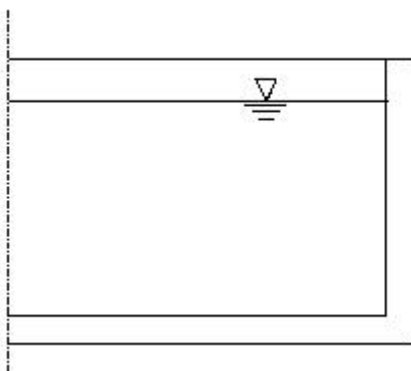

Fig. 95: Activated Sludge Tank

A water depth is suggested in the input field **Chosen Height**. This depth may be accepted or exchanged for another value to be selected. Click **Calculate** and after selecting the **Width** of the tank, click **Calculate** again.

Select the **Length** and calculate the **Volume**. Leave the window with **OK**.

A **circular tank** with flat base is calculated when selecting the option for a **Circular Tank** in the BB (SC extern).

The secondary sedimentation tank is designed as circular tank or rectangular tank and its design is following in the next step.

### Carousel Chamber

The Carrouselbecken can be calculated for 4 lanes or 6 lanes.



**A 131 Activated Chamber**

Dry Solid in the Activated Sludge	3,15 kg/m <sup>3</sup>
Minimum Volume	7034,53 m <sup>3</sup>
Volume Load, Maximum	0,128 kg/(m <sup>3</sup> *d)

Round Tank       Rectangular Tank  
 Plug Flow Reactor       Carrousel

Chosen Height:  m

Calculate

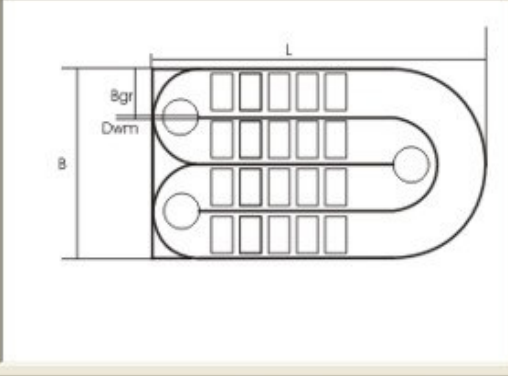

**Carrousel Chamber**

Width of one:  m

Number of Channels:

Total Width: 24,90 m

Länge: 61,50 m

Length of Nitrification Tank:  m

Berechnen

Total Volume: 7055,68 m<sup>3</sup>

Interim Result    **Control Picture**    Cancel    OK

Fig. 96: Carrousel Chamber

The calculation is similar to the circulating pool. The interior walls are deducted from the volume.

If separate stage denitrification is chosen the Carrousel chambers are calculated only for the nitrification volume.

**A 131 Activated Chamber**

Dry Solid in the Activated Sludge	3,15 kg/m <sup>3</sup>
Minimum Volume	7034,53 m <sup>3</sup>
Volume Load, Maximum	0,128 kg/(m <sup>3</sup> *d)

Round Tank       Rectangular Tank  
 Plug Flow Reactor       Carrousel

Chosen Height:  m

Calculate

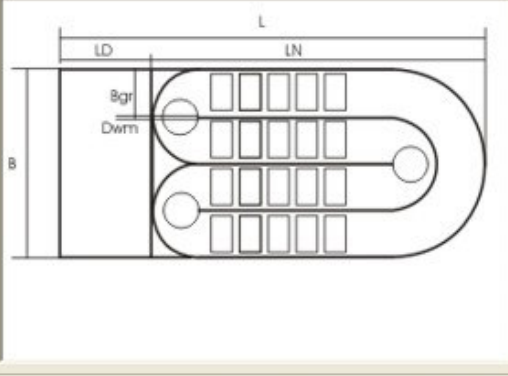

**Carrousel Chamber**

Width of one:  m

Number of Channels:

Total Width: 21,90 m

Length Deni min: 12,85 m

Length Nitri min: 54,99 m

Length Deni:  m

Length of Nitrification Tank:  m

Berechnen

Total Volume: 6932,69 m<sup>3</sup>

Interim Result    Control Picture    Cancel    OK

Fig. 97: Carrousel Chamber: separate stage denitrification

## Volume

Real volume of the activated sludge chamber:

### 1. Circular chamber

$$V_{AT} = \frac{\pi}{4} * H_{AT} * D_{AT}^2 \quad [m^3]$$

### 2. Rectangular chamber

$$V_{AT} = L_{AT} * H_{AT} * B_{AT} \quad [m^3]$$

Using the real activated sludge tank volume the verification of the dimensioning is conducted.

#### **Technical Information: Deep activated sludge tanks**

A report of the ATV work group 2.6 on „Aerobe biologische Abwasserreinigungsverfahren“ (‘Aerobic biological wastewater clarification processes’) points out operational problems with deep activated sludge tanks and following conventional secondary sedimentation tanks.

More carbon dioxide is dissolved in the wastewater because of the higher partial pressure in the deep tank. This results in a carbonate balance shift and possibly in a problematic pH value decrease. The pH value decrease may impair nitrification, disintegrate activated sludge flocs and amplify corrosion of the concrete. The accumulation of carbon dioxide is enhanced by the low requirement for oxygen as the stripping effect is smaller than in flat tanks.

With increased partial pressure in the liquid more nitrogen is dissolved in the wastewater. This dissolved nitrogen will be released with reduced partial pressure. The developing gas bubbles may lead to flotation and, thus, sludge loss. If the agitators are installed on the bottom of the tank, the flow in front of the aeration elements can be deflected upward. Then the water flows back above the agitators.

## 7.9.6 Dimensioning of Aeration

### Generell

The oxygen demand with the resulting air consumption is computed and the appropriate machinery is selected in consideration of the tank geometry.

Preselections have been made depending on the selected clarification processes. For example a mixing device is automatically suggested when denitrification is selected.

The required blowers and mixing devices are available from data banks.

For designing the aeration, a detailed form **membrane aeration** is available. It offers a particular flexible and individual design of the aerator elements and distribution.

### Aerobic Sludge Age

The aerobic sludge age must be considered more precisely for aeration.

The minimum aerobic sludge age is:

$$t_{SA} = PF * 3.4 * 1.103^{(15-t^{Bem})} d$$

$t^{Bem}$ -design temperature ° C

In simultaneous aerobic sludge stabilisation and a sludge age of 25 days, it follows a nitrification ratio with an minimum sludge age

$$V_N / V_D = t_{SA} / t_{TSgesamt}$$

from far below 0.4, or a denitrification ratio of well over 0.6.

Example:

$$T^{Bem} = 12 \text{ ° C}$$

$$PF = 1.6$$

$$t_{TS} = 7.3 d$$

$$t_{TSgesamt} = 25 d$$

$$V_N / V_{AT} = t_{SA} / t_{TSg} = 0.29$$

$$V_D / V_{AT} = 1 - t_{SA} / t_{TSg} = 0.71$$

This results not only in very short aeration times for intermittent denitrification, but also in an impermissible, large denitrification ratio.

Thus, a new aerobic sludge age is calculated. For this purpose, first the denitrification ratio is determined iteratively for the required effluent values for each load case. Then, based on the actually required denitrification ratio, the actual aerobic sludge age and thus also the aeration times are calculated.

$$tL, \max = (1 - V_D/V_{AT\max}) * 24$$

$$t_{\text{Saerob}} > t_{\text{Sgesamt}}$$

If the aerobic sludge age is larger than the total sludge age, the nitrification reaches its limits. In this case, the process factor is first reduced to 1.2 and a reduced aerobic sludge age is calculated with this process factor. If the aerobic sludge age is still larger than the total sludge age, no nitrification takes place.

This happens especially when in a load case, the temperature is greatly reduced.

## DWA-A 131

### Overview of used notations

concentration of oxygen consumption for carbon elimination related to the wastewater feed	$OV_C$	mg/l
daily consumption of oxygen for carbon elimination	$OV_{d,C}$	kg/d
mean daily consumption of oxygen for carbon elimination throughout the year	$OV_{d,C,aM}$	kg/d
daily oxygen consumption	$OV_d$	kg/d
Oxygen demand equivalent in denitrification (nitrate on oxygen covered oxygen consumption of coal substance elimination)	$OV_{C,D}$	mg/l
Oxygen equivalent in the upstream denitrification process in combination	$OV_{C,D,vg}$	mg/l
Oxygen demand from external metered during denitrification carbon	$OV_{C,la}$	mg/l
Oxygen demand from external metered during denitrification carbon in intermittent denitrification	$OV_{C,la,int}$	mg/l
Oxygen demand from external metered during denitrification carbon in denitrification	$OV_{C,la,vorg}$	mg/l
daily consumption of oxygen for carbon elimination, which is covered by the denitrification.	$OV_{d,D}$	kg/d
daily consumption of oxygen for nitrification	$OV_{d,N}$	kg/d
hourly oxygen consumption	$OV_h$	kg/h
average hourly oxygen consumption throughout the year	$OV_{h,aM}$	kg/h
maximum hourly oxygen consumption	$OV_{h,max}$	kg/h
minimum hourly oxygen consumption	$OV_{h,min}$	kg/h

$OV_C$  quantifies the total oxygen consumption for the reduction of carbon compounds and results from the following formula:

$$OV_C = C_{\text{COD, fig, ZB}} + C_{\text{COD, dos}} - X_{\text{COD, BM}} - X_{\text{COD, inert, BM}} \text{ [mg / l]}$$

Oxygen demand of easily degradable COD and external dosed COD

Upstream

$$OV_{C, la, vorg} = f_{\text{COD}} * C_{\text{COD fig, Gr}} (1 - Y) + C_{\text{COD, dos}} * (1 - Y_{\text{COD, dos}}) \text{ [mg / l]}$$

Intermittent

$$OV_{C, la, int} = C_{\text{COD, dos}} * (1 - Y_{\text{COD, dos}}) \text{ [mg / l]}$$

$f_{\text{COD}}$  - ratio of  $C_{\text{COD, la, ZB}} / C_{\text{COD, fig, ZB}}$

For the oxygen consumption in the denitrification zone is true for the various methods

upstream denitrification

$$OV_{C,D} = 0,75 * \left[ OV_{C,la,vorg} + (OV_C - OV_{C,la,vorg}) * \left( \frac{V_D}{V_{AT}} \right)^{\alpha_{DB}} \right] \text{ [mg/l]}$$

alphaDB = 0,68 für 8 – 20°C

Adaptation to warm and cold climate, Extension of the design to 5 – 30 °C /64/

Process	alphaDB depending on the Temperature T <sub>w</sub> [°C]			
	5 – 8	8 – 20	20 – 25	25 – 30
Plants with primary sedimentation	0,64	0,68	0,75	0,76
Plants with extended aeration	0,60	0,68	0,72	0,75

intermittent denitrification with dosage of external substrate during denitrification

$$OV_{C,D} = 0,75 * \left[ OV_{C,la,vorg} + (OV_C - OV_{C,la,int}) * \left( \frac{V_D}{V_{AT}} \right) \right] \quad [mg/l]$$

simultaneous denitrification without upstream anaerobic tank

$$OV_{C,D} = 0,75 * OV_C * \left( \frac{V_D}{V_{AT}} \right) \quad [mg/l]$$

Process combination upstream followed by simultaneous / inermittent denitrification, if at least 15% of total volume run as pre-denitrification

$$OV_{C,D} = 0,75 * \left[ OV_{C,la,vorg} + (OV_C - OV_{C,la,vorg}) * \left( \frac{V_D}{V_{AT}} \right)^{0,68} \right] \quad [mg/l]$$

The nitrate to be denitrified is known from nitrogen balance.

SNO3D = CN, ZB - SorgN, ON - SnH4, ON - SNO3, ON - XorgN, BM - XorgN, inert  
[mg / l]

The denitrification ratio is calculated iteratively with the following formula

$$x = \frac{OV_{C,D}}{2,86 * S_{NO3,D}}$$

Then, the oxygen supply of nitrate corresponds to the oxygen consumption of carbon in the denitrification zone.

## Oxygen Demand

### DWA-A131, Specific Oxygen Demand

The BOD<sub>5</sub>- and N-load as well as the selected clarification processes are the foundation for the computation of the oxygen demand.

The specific oxygen demand (OV<sub>C</sub> and OV<sub>N</sub>) results mainly from the degradation of organic carbon compounds and nitrogen compounds by microorganism.

OV<sub>C</sub> names the specific oxygen demand for the degradation of carbon compounds and results from the following equation:

#### DWA-A131, 2000

For  $C_{\text{COD,ZB}}/C_{\text{BOD,ZB}} \leq 2$ :

$$OU_{d,c} = 0,56 + \frac{0,15 * t_{SS} * F_T}{1 + t_{SS} * 0,17 * F_T} \left[ \frac{\text{kgO}_2}{\text{kgBOD}_5} \right]$$

$$F_T = 1,072^{(T-15)} \quad \begin{array}{l} \text{Temperature Factor} \\ T_{SA} \quad \text{Sludge Age} \quad [d] \end{array}$$

For  $C_{\text{COD,ZB}}/C_{\text{BOD,ZB}} > 2$  the specific oxygen demand has to be calculated based on the COD.

#### Information:

The higher the sludge age the better the degradation of the organic matter and thus, the degree of sludge mineralisation. Oxygen is required for the degradation steps. Therefore the specific oxygen demand for carbon compound degradation OV<sub>C</sub> increases with increasing sludge age.

The velocity of chemical and biological reactions increases with an increase of the temperature. Hence the oxygen demand rises with the temperature as well.

The upper value limit for the OV<sub>C</sub> is 1,6 kgO<sub>2</sub>/kgBOD<sub>5</sub>. according to the ATV A 131 /39/ guideline.

T °C	Sludge Age in Days	
	15	25
10	1,32	1,55
12	1,38	1,60
15	1,46	1,60
18	1,54	1,60
20	1,60	1,60

Excerpt from Table 10, A131; Specific Oxygen Demand OV<sub>C</sub> in kgO<sub>2</sub>/kgBOD<sub>5</sub>

The specific oxygen demand for the degradation of nitrogen compounds OV<sub>N</sub> is

dependent on the selection of nitrification and/or denitrification for clarifying processes. In the nitrification process oxygen is required for oxidation of ammonia to nitrite and nitrate as demonstrated in the chemical equations in the chapter on the foundations.

The nitrate is reduced to elementary nitrogen and in a small amount to N<sub>2</sub>O in the denitrification process. The nitrate nitrogen is used for the anoxic respiration. The denitrification reduces the required oxygen demand for nitrogen compound degradation.

On the basis of the above described processes  $OV_N$  results in:

$$OU_{d,N} = Q_d * 4,3 * \frac{S_{NO3,D} - S_{NO3,ZB} + S_{NO3,AN}}{1000} \quad \left[ \frac{kgO_2}{d} \right]$$

$$OU_{d,D} = -Q_d * 2,9 * \frac{S_{NO3,D}}{1000} \quad \left[ \frac{kgO_2}{d} \right]$$

NO <sub>3</sub> -Ne	Nitrate-N concentration in outlet (outflow)	[mg/l]
NO <sub>3</sub> -Nd	Denitrified nitrate concentration	[mg/l]
BOD <sub>5</sub>	BOD <sub>5</sub> concentration in inlet (inflow)	[mg/l]

### DWA-A131, Oxygen Charge

Shock loads must be considered for evaluating the oxygen charge. Therefore, shock factors ( $f_c$ ,  $f_N$ ) are introduced for nitrogen and carbon compounds. These are presented in the following table referring to the range of application in the AQUA DESIGNER and based on the ATV A 131 /39/.

T in °C	Sludge Age in Days					
	4	6	8	10	15	25
$f_c$	1,3	1,25	1,2	1,2	1,15	1,10
$f_N$ for ≤ 20.000 EW	-	-	-	2,4	2,00	1,50
$f_N$ for > 100.000 EW	-	-	2,0	1,8	1,50	-

Table 10, Shock factors according to ATV A131

The oxygen charge on the one hand results from the specific oxygen demand and on the other hand from the laws of diffusion that describe the transfer of oxygen from the gas bubble into the water. The difference between oxygen saturation concentration and true oxygen concentration in the wastewater is important for the oxygen transfer.

$$OV = \frac{C_s}{C_s - C_x} * (OV_c * f_c + OV_N * f_N) \quad \left[ \frac{kgO_2}{kgBOD_5} \right]$$

$$OV_h = \frac{f_c * (OV_{d,C} - OV_{d,D}) + f_N * OV_{d,N}}{24} \quad \left[ \frac{kgO_2}{h} \right]$$

Cs	Oxygen saturation concentration	[mg/l]
Cx	Oxygen concentration in the tank	[mg/l]

The oxygen concentration in the activated sludge tank is postulated as 2 mg/l for sole nitrification. An oxygen concentration of 2 mg/l is selected for the aeration period in wastewater plants with intermittent denitrification as well. The saturation concentration is 11,24 mg/l at 10 °C and 9,18 mg/l at 20°C.

Oxygen saturation concentration in water depending on the water temperature at norm pressure 1013 hPa (DIN 38408, Part 22)

T °C	cs mg/l
4	13,1
6	12,4
8	11,8
10	11,3
12	10,8
14	10,3
16	9,9
18	9,5
20	9,1
22	8,7
24	8,4
26	8,1
28	7,8
30	7,6

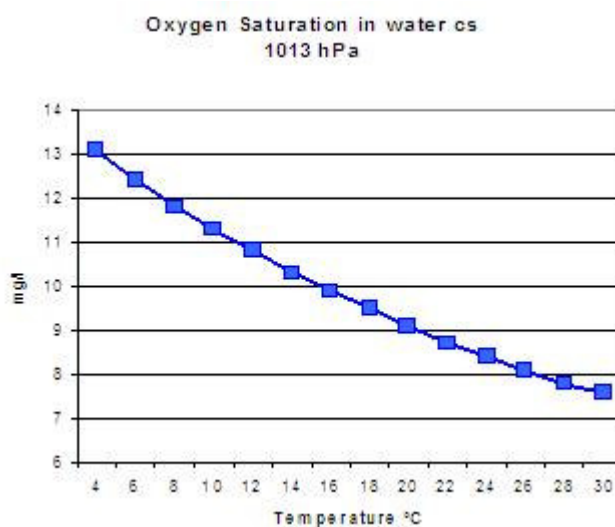

## Load Cases

The load cases and the design of aeration and circulation equipment are based on the data sheet DWA-M 229-1 / 59 /.

The starting point are the determinations of oxygen demand and the impact factors from the DWA A131 / 2 /. On the basis of these values, at least 4 load cases for the design of the aeration system and the gradation of the blowers have to be checked. AQUA DESIGNER lists two more load cases, load cases 0 and 5, to provide additional information.

### Load case 0: Oxygen demand under design conditions

Design temperature, design sludge age and minimum volume

### Load case 1: Average oxygen demand in the actual state, OVh, aM

Evaluation of annual values, e.g. economics

Load case with mean annual load and mean annual temperature



$$OV_{h,aM} = \frac{(OV_{d,C,aM} - OV_{d,D,aM}) + OV_{d,N,aM}}{24} \left[ \frac{kgO_2}{h} \right]$$

### Load case 2: Maximum oxygen demand in actual state, OVh, max

Dimensioning of aeration and mixing device

highest water temperature, unfavorable load case

Special cases that affect the maximum oxygen demand, e.g. seasonal peaks are to be considered here.

$$OV_{h,max} = \frac{fC * (OV_{d,C,max} - OV_{d,D,max}) + fN * OV_{d,N,max}}{24} \left[ \frac{kgO_2}{h} \right]$$

### Load case 3: Minimum oxygen demand in the actual state, OVh, min

Gradation of blowers and surface aerators, proof of the minimum load of aerators.

The minimum load situation for two different states is taken into account. Accordingly, OV can be chosen after two different approaches.

a) no significant load proportion at night inflow

$$\frac{OV_{d,C,aM}}{\left( \frac{3,92}{tTS * 1,072^{(T_w-15)} + 1,66} \right) * 24} \left[ \frac{kgO_2}{h} \right]$$

b) significant load proportion at night inflow

$$OV_{h,min} = \frac{f_{C,min} * (OV_{d,C,min} - OV_{d,D,min}) + f_{N,min} * OV_{d,N,min}}{24} \left[ \frac{kgO_2}{h} \right]$$

### Load case 4: O<sub>2</sub> demand values for prognosis and possibly revision status

Additional load case to guarantee process flexibility

### Load case 5: free, AQUA DESIGNER

possibility to additionally illustrate a special operating status

### Low Loads

If the load of the plant is less than 30% in comparison to the calculated average capacity, it is necessary to determine the supply of oxygen  $f_N = 1$  and  $f_C = 1$  for the real load. This value serves for the better gradation of the fans, resp. aeration units. You can easily determine the gradation through the consideration of loading conditions under **Extras > Calculation of loading conditions**.

### SOTR compressed air aeration

The calculation path from the determined oxygen demand to the air volume is the same for all load cases. However, AQUA DESIGNER offers the experienced engineer the opportunity to choose different operating parameters for each load case. Thus, the oxygen concentration can be set differently during operation for the load cases.

Decisive factor for the design of the aeration device is the necessary oxygen supply SOTR.

$$SOTR = \frac{f_d * \beta_{St} * c_{s,20} * f_{S,ST}}{\alpha * f_{S,\alpha} * (f_d * \beta_\alpha * c_{S,T} * \frac{p_{atm}}{1.013} - c_x) * \Theta^{(TW-20)}} * OV_h \quad \left[ \frac{kgO_2}{h} \right]$$

Here are various influencing factors

- Altitude above sea level for adjusting the atmospheric pressure and thus the saturation concentration.
- Depth factor for the water depth
- Interface factor for the conversion of pure water to dirty water
- Oxygen saturation concentration at operating temperature
- Oxygen saturation temperature at 20 ° as base temperature for temperature factors
- Salt factor due to the influence on the surface tension

### Air pressure depending on the geodetic altitude

$$p_{atm} = 1.013,25 * \left( \frac{288 - 0,0065 * h_{geo}}{288} \right)^{5,255} \quad [hPa]$$

### Depth factor for the water depth

$$fd = 1 + hD / 20.7$$

$h_D$  -air introduction m

### Interface factor, conversion to waste water

The determined oxygen load according to the described algorithm applies to the oxygen injection in pure water. In the wastewater, biological degradation processes take place. In addition, the oxygen injection is negatively affected by the differing properties of wastewater, e.g. due to the different surface tension. Because of this, more air must be added to wastewater to maintain the desired oxygen concentration.

For the conversion of oxygen demand from pure water to waste water, the interface factor  $\alpha$  is introduced. The interfacial factor is very variable and depends on many wastewater and operating conditions.

Recommended  $\alpha$ -values from leaflet M 229-1, Table 1/60/.

SBR method for nitrogen elimination	$\alpha = 0.60-0.85$
MBR method	$\alpha = 0.50-0.70$
Simultaneous aerobic sludge stabilization	$\alpha = 0.70-0.90$

Different  $\alpha$ -values are given by Gunkel-Lange KA 11/2015 or /60/, page 37.

An interesting aspect is for example that the interfacial factor is highly dependent on the sludge load. Rising  $\alpha$ -values are to be expected in the case of pronounced plug flow or in the case of tanks flowed in series, if no load equalisation takes place along the flow path.

The  $\alpha$  value is used to convert from pure water conditions to dirty water conditions. This amount of oxygen is therefore needed in order to be able to cover the oxygen demand, as determined above for pure water, also in the waste water. However, since the value increased by the factor  $\alpha$  must be detected before commissioning a system in pure water, it is usually referred to as oxygen supply in pure water.

The oxygen supply in pure water results according to the following formula:

$$SOTR_{\text{Reinwasser}} = \frac{\alpha SOTR}{\alpha} \quad \left[ \frac{\text{kgO}_2}{\text{h}} \right]$$

Oxygen saturation as a function of the temperature

$$c_{s,T} = \frac{2.234,34}{(TW + 45,93)^{1,31403}} \quad [\text{mg/l}]$$

### Salt factor

The salt factor is  $\beta = 1$  and  $f_{\text{ST}, \text{ST}} = 1$  under normal conditions. This applies to the standard concentrations of  $<1$  mg/l.

In arid regions, sea water is often used for toilet flushing. Then, of course, the salt concentration also increases in the sewage. Also, there can be significant increases in salt concentration near the sea by infiltration of saline groundwater into leaky channels. Another application is special industrial wastewater. / 60 /

### Increase factor $f_{\text{int}}$

#### Intermittent

If aeration is intermittent, air is only introduced during the nitrification phase and not for 24 hours. The necessary hourly oxygen supply must be converted to the shortened aeration time.

$$f_{\text{int}} = \frac{1}{1 - \frac{V_D}{V_{\text{BB}}}}$$

$$SOTR_{\text{int}} = SOTR * f_{\text{int}} [\text{kgO}_2 / \text{h}]$$

### Combined upstream and intermittent denitrification

For combined upstream and intermittent denitrification, at least a part of  $0.15 \cdot V_{BB}$  is applied as upstream denitrification.

For intermittent denitrification then:

$$V_D / V_{BB}^{\text{intermittent}} = V_D / V_{BB}^{\text{gesamt}} - V_D / V_{BB}^{\text{vorgeschaltet}}$$

$$f_{\text{int,komb.}} = \frac{1}{1 - \frac{V_D}{V_{BB}^{\text{ermittierend}}}}$$

### SBR conversion factor

For SBR systems, aeration time must also be converted to reaction time.

$$f_{SBR} = \frac{1}{mZ \cdot tR}$$

mZ = number of cycles per day in d-1

tR = duration of the reaction phase in h

$$SOTR_{SBR} = SOTR \cdot f_{SBR} \cdot 24 \text{ [kgO}_2 \text{ / h]}$$

### Amount of air

#### Under standard conditions

The air requirement arise out of the specific oxygen supply and the blow-in depth.

$$QL, N = \frac{1.000 \cdot SOTR}{SSOTR \cdot hD} \quad \left[ \frac{m_N^3}{h} \right]$$

SOTR necessary oxygen supply [kgO<sub>2</sub> / h]

SSOTR specific oxygen supply gO<sub>2</sub> / (m<sup>3</sup>xm)

h<sub>D</sub> depth of air introduction m

The specific oxygen utilisation is a product specific value. The manufacturer's information is always determined on the basis of the operational conditions, e.g. the load of aerators and the area occupancy.

The oxygen aeration efficiency can be declared as specific oxygen utilisation SSOTE in % / m or as SSOTR in gO<sub>2</sub> / (m<sup>3</sup>xm).

At 300 gO<sub>2</sub> / m<sup>3</sup> it applies:

$$SSOTE = SSOTR / 3$$

In AQUA DESIGNER a value of  $19 \text{ gO}_2 / (\text{m}^3 \cdot \text{m})$  is preset. This value is according to the state of technology conservative usable for areal occupation and separate circulation and aeration.

It is recommended to request the specific oxygen utilisation for the selected arrangement of aerators and for the amount of air injection.

### Volume flow rate of the intake air

The above mentioned determination of the amount of air was carried out for standard conditions.

$T_N$	temperature in the physical standard state 273.15 K
$p_N$	standard air pressure 1,013 hPa
$\rho_N$	Density of air under standard conditions 1,293 kg / m <sup>3</sup>
$\varphi$	relative humidity %

The determined volume flow rate for standard conditions  $Q_{L,N}$  has to be converted to the suction state Q 1 of the air compressor.

$$Q_1 = \frac{p_N * (T_{L,1} + T_N)}{p_{1,abs} * T_N} * Q_{L,N} \quad \left[ \frac{\text{m}^3}{\text{h}} \right]$$

$$Q_1 = \frac{T_N + T_{L,1}}{T_N} * \frac{p_N}{p_{1,abs} - \varphi * p_S} * Q_{L,N} \quad \left[ \frac{\text{m}^3}{\text{h}} \right]$$

$p_{1,abs}$	Absolute pressure on suction side of the blower	hPa
$T_{L,1}$	Temperature of sucked air	°C
$p_S$	Saturation vapour pressure	hPa

$$p_S = \frac{6,112 * \text{EXP}(17,62 * T_{L,1})}{243,12 + T_{L,1}} \quad [\text{hPa}]$$

### Absolute pressure on suction side

$$p_{1,abs} = p_{atm} - \Delta p_1 \quad [\text{hPa}]$$

$p_{atm}$  for SOTR was already calculated above.

The pressure loss on the suction side is an operating value.

### Density for suction conditions

$$\rho_1 = \rho_N * \frac{T_N}{T_N + T_{L,1}} * \frac{p_{1,abs} - \varphi * p_S}{p_{N,abs}} + \varphi * \rho_S \quad \left[ \frac{\text{kg}}{\text{m}^3} \right]$$

$\rho_S$	water vapour density in saturation conditions	kg/m <sup>3</sup>
----------	---	-------------------

$$\rho_s = \frac{p_s * 0,018015}{8,315 * (273,15 + T_{L,1})} \quad \left[ \frac{kg}{m^3} \right]$$

### SOTR Surface Aeration

For the necessary oxygen supply it applies:

$$SOTR = \frac{f_d * \beta_{St} * c_{s,20} * f_{S,ST}}{\alpha * f_{S,\alpha} * (f_d * \beta_\alpha * c_{S,T} * \frac{p_{atm}}{1.013} - c_x) * \Theta^{(TW-20)}} * OV_h \quad \left[ \frac{kgO_2}{h} \right]$$

$f_d$  factor of depth for surface aeration

$$f_d = h_{BB}/150$$

### Power of surface aerators

The power of the surface aerators can be determined by the oxygen efficiency value SAE.

The oxygen efficiency value is in the range of 1,6 – 2,0 kgO<sub>2</sub>/kWh.

Pöpel /28/, Seite 1.56 gilt

	Oxygenation	Oxygen yield
Rotators in circulation tanks	11,75 + 1,40 * LD	1,97 – 0,0058 * LD
Spinning tops in mixing tanks	10,73 + 1,96 * LD	1,41 + 0,0055 * LD
Spinning tops in circulation tanks	-2,05 + 2,58 * LD	2,36 – 0,0121 * LD not statistically secure

### Conversion based on working pressure

The concentration of oxygen saturation is dependent on working pressure. If the pressure increases, the solubility of oxygen also intensifies. This means for the determination of oxygen demand at compressed aeration, that the concentration of oxygen saturation is higher at the blow-in point than at the water surface. The dependence of the solubility upon the depth level of the blow-in point is taken into account by average pressure. The average pressure corresponds to the hydrostatic pressure at the half depth of the blow-in point.

For the conversion of the solubility of oxygen from environment pressure into the pressure at the half blow-in point Wagner /28/ indicates a correction factor:

$$c_{s,m} = c_s * \left( 1 + \frac{de}{20,7} \right) \quad \left[ \frac{mg}{l} \right]$$

$$\begin{array}{lll} de & \text{Depth of the blow-in point} & m \\ 20,7/2 = 10,33 & \text{Pressure at } 1013,25hPa & mWS \end{array}$$

In the A131 this correction factor was not indicated. In comments to A 131 /39/ from Kayser /45/ this adjustment was however also applied. Therefore in practice it

should be taken into account.

### Higher reaction temperature

If you select higher reaction temperature, resp. dimensioning temperature higher than 10°C, the loading conditions for maximum C and N-pollution are also calculated for the selected temperature and taken into account while choosing the maximum of the loading conditions.

According to Lutz Härtel /1/ the concentration of oxygen saturation can be calculated dependent on the temperature.

$$C_{s, \text{theor.}} = \frac{2234,34}{(T + 45,93)^{1,31403}} \quad \left[ \frac{\text{gO}_2}{\text{m}^3} \right]$$

Pöpel additionally indicates a correction factor for the depth of the blow-in point.

$$C_{s,H} = c_{s, \text{theor.}} * (1 + 0,1 * hE) \quad \left[ \frac{\text{gO}_2}{\text{m}^3} \right]$$

### DWA-A131

To determine the maximum oxygen load, various loading conditions are calculated : three different temperatures are taken into account.

Loading condition winter	The temperature, which is also accepted while calculating the volumes of the vitalizing sludge basin under loading conditions winter, is also accepted as the lowest temperature. It is the lowest 2 weeks average temperature in winter. Here in Germany the temperature of is usually accepted.
Dimensioning temperature	The average loading condition is the oxygen demand at the measured temperature. The recommended measured temperature is 12°C in Germany.
Highest temperature	20°C is usually accepted as the highest temperature. Due to lower solubility of oxygen in water at higher temperatures, this temperature is determined to be the most unfavourable loading condition for the aeration.

Different loads are computed to evaluate the maximum oxygen charge:

### Nitrification/Denitrification

Temperature 10 °C

- Maximum C-load, medium N-load

- Medium C-load, maximum N-load

Temperature 20 °C

- Maximum C-load, medium N-load
- Medium C-load, Maximum N-load

### Nitrification

Temperature 10 °C

- Maximum C-load, medium N-load
- Medium C-load, maximum N-load

Medium N-load always refers to a shock factor of  $f_N$  equal to 1. This applies analogue to the medium C-load.

Altogether six events of loads are reviewed when selecting nitrification/denitrification. Without denitrification only the two loads for 10°C result.

The oxygen charge results as maximum from the examined load cases. Note that different aeration periods apply for nitrification and denitrification.

#### Technical Information:

The metabolism for degradation of organic compounds and nitrification is dependent on the oxygen concentration in the activated sludge tank. The higher the oxygen concentration in the activated sludge tank the faster the biochemical reactions. The relation corresponds to 1st class chemical reactions.

$$\frac{dc}{dt} = kLa * (Cs - C)$$

Experiments show an economic operation of the aeration when maintaining an oxygen concentration of about 2 mg/l.

For maintaining higher oxygen concentrations in the activated sludge tank the additional aeration energy consumption in the activated sludge tank outweighs the increase in metabolism.

The nitrification reaction velocity reduces considerably for oxygen concentrations below about 0,5 mg/l.

The oxygen charge evaluated according to the described algorithm is valid for oxygen transfer in clear water. Consumptive processes occur in the wastewater. Therefore more oxygen must be transferred into the wastewater in order to maintain the selected oxygen concentration.

The oxygen supply factor  $\alpha$  is introduced for the conversion of the oxygen demand of clear water to wastewater. The oxygen supply factor is dependent on the selected aeration system and on the water depth. Pöpel gives oxygen supply factors for different aeration systems /15/.

Equal area aeration (Nitrification):  $\alpha = 0,62$

Separate mixing and aeration(Denitrification):  $\alpha = 0,70$



The wastewater oxygen charge results from the following equation:

$$OB_{wastewater} = \frac{OB_{purewater}}{\alpha} \left[ \frac{kgO_2}{kgBOD_5} \right]$$

In the following it is:  $OB = OB_{wastewater}$ .

### DWA-A131, Hourly Oxygen Supply

The required hourly oxygen supply results from the oxygen charge, BOD<sub>5</sub>-load and blower operation period:

$$OB = \frac{OB * B_{d,BOD5}}{tL_{dim}} \left[ \frac{kg}{h} \right]$$

The aeration period  $tL_{dim}$  is: Nitrification: 24 [h/d]

The anoxic time is calculated, based on the denitrification volume.

Denitrification: ca. 16 [h/d]

### DWA-A 226

The tubular diffuser fine bubble aeration with combined and separate mixing is the available aeration system.

In contrast to the A131 a value is preselected for the oxygen charge:

Nitrification

$$OB = 3,0 [kgO_2/kg_{BSB5}]$$

Nitrification/Denitrification

$$OB = 2,5 [kgO_2/kg_{BSB5}]$$

The hourly oxygen supply results as follows:

$$OC = \frac{OB * B_{d,BOD5}}{tL_{dim}} \left[ \frac{kg}{h} \right]$$

Aeration Period  $tL_{dim}$ :

Nitrification: 24 [h/d]

Denitrification: 16 [h/d]

This value generally covers the micro-organism oxygen consumption for nitrogen

and carbon oxidation. Is the ratio

$$\text{TKN} : \text{BOD}_5 < 1 : 3,5 \quad \text{in the influent}$$

above the limit, it is recommended to demonstrate the required oxygen demand for nitrogen oxidation separately.

## 7.9.7 Technique of Aeration

### Membrane Aeration

Most commonly the air is introduced with tubular diffusers in pneumatic aeration. For this type of aeration suitable values are preselected in the AQUA DESIGNER forms. Product specific data may be entered into the according input fields for different types of aerators, for example ceramic aerators.

### Air Consumption

In the form **Aeration**, an oxygen transfer capacity of 8 g/(m<sup>3</sup>\*m) is preselected for the **combined mixing and aeration**. Here the ATV recommends

$$fO_2 = SSOTR = 8 - 10 \quad \left[ \frac{\text{g}}{\text{m}^3 * \text{m}} \right]$$

The **separate mixing and aeration** is recommended for wastewater plants serving a population equivalent of more than 600. This also applies when denitrification is not required. Otherwise sludge deposition in critical tank areas is to be expected.

The oxygen transfer is preselected as 12 g/(m<sup>3</sup>\*m). Here the ATV guideline recommends

$$fO_2 = SSOTR = 12 - 15 \quad \left[ \frac{\text{g}}{\text{m}^3 * \text{m}} \right]$$

The **required hourly air volume** results from the evaluated hourly oxygen supply and the immersion depth.

$$Q_L = \frac{OC * 1000}{fO_2 * h_E} \quad \left[ \frac{\text{m}^3}{\text{h}} \right]$$

Q <sub>L</sub>	req. hourly air volume	[m <sup>3</sup> /h]
f <sub>O<sub>2</sub></sub>	Oxygen transfer factor	[g/(m <sup>3</sup> *m)]
h <sub>E</sub>	Immersion depth	[m]
OC	Oxygen supply	[kg/h]

**Technical Information:**

The immersion depth is set 30 cm above the tank base being 30 cm less than the activated sludge tank water depth.

This is an effect of the aeration system construction. The aeration plugs or discs are fixed to aeration screens set up on the activated sludge tank base.

In the form for Details (Menu Options → Details) you can access the immersion depth and change the distance between injection depth and water depth.

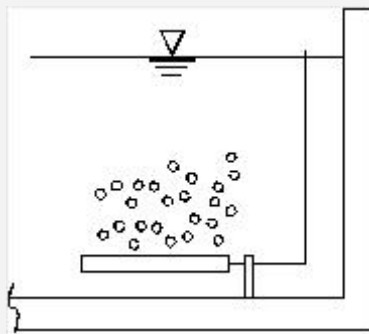

Fig. 98: Immersion depth

**Blower**

The number of blowers is entered in the window for selecting the blowers. The required blower air volume results from the calculation of the required air volume and the number of blowers.

A screenshot of a software window titled "Blower". The window has a light gray background and a dark gray border. At the top left, the title "Blower" is displayed. Below the title, there is a label "Number of Blowers" followed by a text input field containing the number "2". Below the input field is a button labeled "Data Bank". At the bottom of the window, there is a table of calculated values:

Motor Power	11,0 kW
Air Volume of each Blower	404 m <sup>3</sup> /h
Pressure Height	650 mbar
Air flow for the dimensioning of the membrane aerator	808 m <sup>3</sup> /h

Fig. 99: Selecting the blower

The blowers are selected from the data bank. See the chapter on data banks for details on data bank function and operation.

A stand by blower is not considered in this calculation. Thus, when selecting three blowers these three blowers are used in the further set up of the aeration operation. When selecting multiple parallel lines or multiple activated chambers, respectively, two blowers are suggested for each line by the program appearing in the field **Number of Blowers**. You may enter any other number of blowers. The total capacity of the blowers will be equally distributed on the lines.

## Aeration Devices

Clicking on **Membrane Aeration** leads you to the aeration system design after having completed the previous calculations in the aeration form.

The Membrane Aeration form consists of three parts.

The left part allows the design of the aeration unit by entering data and selecting options.

The right upper part displays the complete unit arrangement for one chamber.

The right lower part displays a magnified lattice. In this window characteristic data of the complete system and of one lattice are presented.

1 Becken  
Gesamtlänge  
Erforderlich: 533,3 m  
Gewählt: 540,0 m  
Anzahl Gitter: 4,0  
1 Gitter:  
Mindestlänge: 133,3 m  
Anzahl Kerzen: 180,0  
Einzellänge: 0,75 m  
Gesamtlänge: 135,0 m

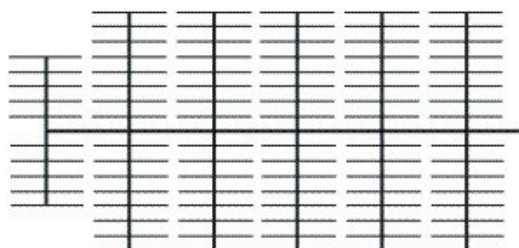

Fig. 100: Characteristic data for one lattice

All values displayed in the Membrane Aeration form refer to one chamber only.

## Design of Lattices

In the window for the design of the lattices the aeration lattices are designed and the distribution of aeration and circulation in one activated chamber is determined.

The input field **Number of Lattices** determines the number of lattices distributed in each chamber. AQUA DESIGNER calculates the required number of tubes or discs per lattice based on the required air volume and the number of lattices. The air volume flow results from the blower capacity.

You may select tubular diffusers or aerator discs by clicking on the according option in the program.

The field Mixer 1 Group enables you to distribute the mixers in the chamber. One mixer per group is preselected by the program. This determines the uniform distribution of the mixers around the circumference (for circular chambers) or over the

length (for rectangular chambers).

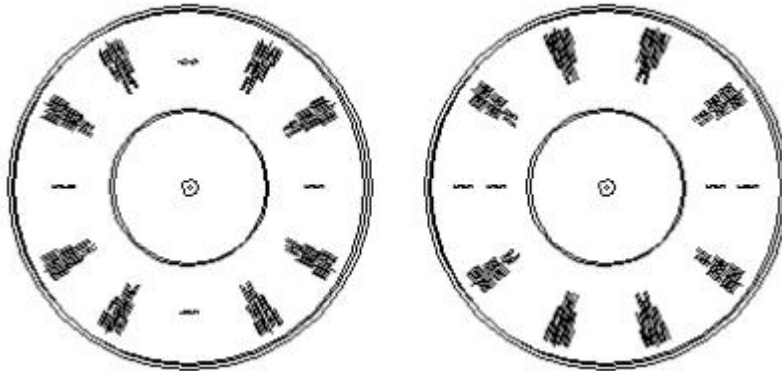

Fig. 101: Selection of mixers per group, one mixer per group in the left example and two mixers per group in the right example

Enter the value 2 into the input field Mixer 1 Group for placing two mixers close together or two mixers per group. Two segments are set up in the chamber when selecting a total of four mixers for one chamber and two mixers per group.

The type of lattice is determined by entering the **Number of Header Pipes** in the window for **Design of Header Pipes**. This decides over the connection of the aerators to the central pipe or to distributing header pipes.

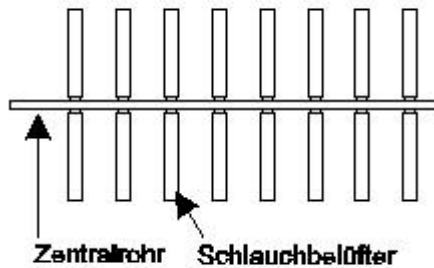

Fig. 102: Aeration lattice without header pipes

Schlauchbelüfter = tubular aerators

Zentralrohr = center pipe

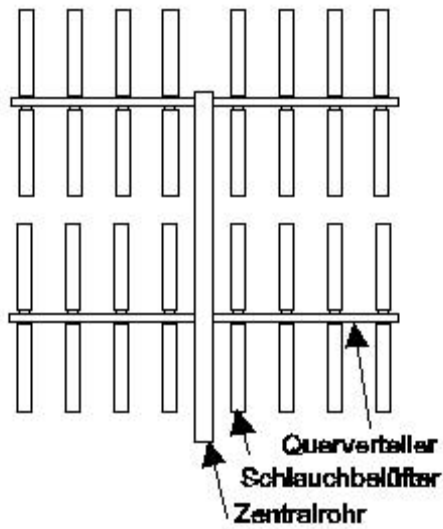

Fig. 103: Aeration lattice with header pipes

Schlauchbelüfter = tubular aerators

Zentralrohr = center pipe

Querverteiler = header pipe

When selecting more than one header pipe the **equal or graded distribution** of membrane aerators is available. For example for the circular chamber it may be useful to reduce the number of tubes or discs towards the centre as the water volume is larger in the outer parts and more air volume is required here.

When selecting aerator discs corresponding header pipes must be selected as it is not possible to connect discs directly to the central pipe.

Fig. 104: Window for determining lattices

In the input field for Steps (Grading) the graded distribution of discs or tubes is selected and modified. This is particularly useful for lattices with disc aerators. A large number of header pipes is usually selected for disc aerators. By entering 3 for the grading it is possible to reduce the number of discs on each header pipe after every third header pipe.

You have the option to choose tube or disc diffusers. Click to the desired option.

In the window for tubular diffuser and disc aerator the geometry of the aerators is determined and the load per aeration unit is entered. When selecting tubular diffusers the according window is open. Here the length for one aeration unit and the load per meter of aerator is entered.

The required aeration plug length results from the recommended aerator load that is the introduced air volume per aerator length.

$$L_{Aerator} = \frac{Q_L}{B_{Aerator}} \quad [m]$$

$L_{Aerator}$	effective aerator length	$[m]$
$Q_L$	hourly air volume current	$[m^3/h]$
$B_{Aerator}$	Aerator load	$[m^3/(m \cdot h)]$

The aerator load is preselected in the input **field Load of Aerators, max.** The user may select a higher or lower aerator capacity.

Economic operational results are achieved with plug capacities of about

$$B_{Aerator} = 7,5 \left[ \frac{m^3}{m \cdot h} \right]$$

**Technical Hints:**

With an increase of the aerator load the pressure drop increases. This has a negative impact on the operation costs. Therefore operation and investment costs are to be weighed in the layout.

The aerators are produced in different lengths. One segment usually consists of two plugs of 0,75 m or 1,0 m length. From that a construction group results consisting of two plugs with a total length of 1,5 m or 2,0 m. These plugs are arranged at distributing pipes as a screen.

When disc aerators were selected the according window is open. Enter the diameter of the disc aerators into the input field for **Diameter of disc aerators**. The value depends on the selected manufacturer. The suggested value is based on the most common designs.

Note that the disc aerator design is not based on its surface area. The aerator load is given per aerator unit or per disc as commonly practised.

$$n_{Teller} = \frac{Q_L}{B_{Disc}}$$

$n_{Teller}$	Number of discs	
$Q_L$	Hourly air volume current	$[m^3/h]$
$B_{Disc}$	Disc aerator load	$[m^3/(Disc \cdot h)]$

$$B_{Teller} = 8,0 \left[ \frac{m^3}{disc \cdot h} \right]$$

For strip diffusors the surface load determines the number of aerators. The size and the geometry is here also input so that all manufacturers, even plate aeratores can be inserted.

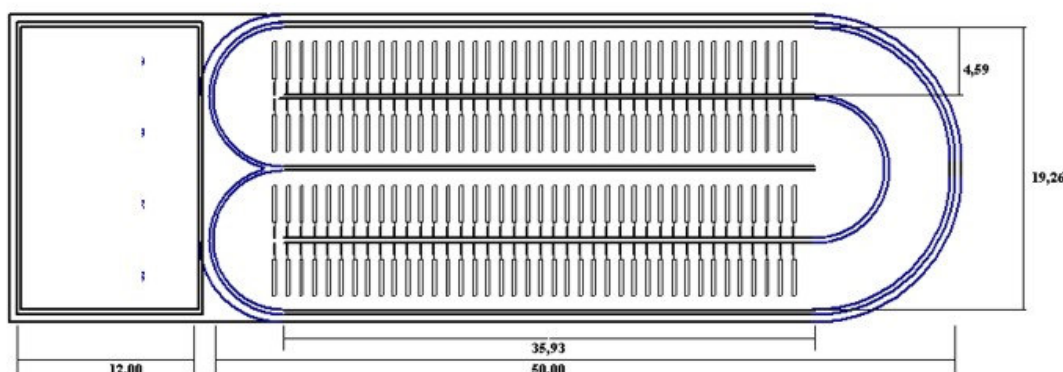

Fig. 105: strip aerators in the nitrification tank



$$n_{\text{Streifenblüfer}} = \frac{Q_L}{B_{\text{Streifenblüfer}} * A_{\text{Streifenblüfer}}}$$

$n_{\text{Teller}}$	number of discs	
$Q_L$	hourly air volume	$[m^3/h]$
$B_{\text{Streifenblüfer}}$	load of the strips	$[m^3/(m^2*h)]$
$A_{\text{Streifenblüfer}}$	area of the strips	$m^2$

$$B_{\text{Streifenblüfer}} = 25,0 \left[ \frac{m^3}{\text{Teller} * h} \right]$$

## Equipment

In the Database field, you have the option of selecting aerator makes with the associated product properties.

Hersteller	Baureihe	Fabrikat	Länge (mm)	Gasungslänge (mm)	Durchmesser (mm)	Perforationsfläche (m²)	Blüferbeaufschlagung Min (Nm³/m.h)
Passavant	Bioflex	IV HPI Silikon 500 mm	550	0,092	63	0,092	2
Passavant	Bioflex	IV HPI Silikon 750 mm	800	0,123	63	0,123	2
Passavant	Bioflex	IV HPI EPDM 750 mm	800	0,123	63	0,123	2
Passavant	Bioflex	II Silikon 750 mm	855	0,126	70	0,126	3
Passavant	Bioflex	II EPDM 750 mm	855	0,126	70	0,126	3
Passavant	Bioflex	IV HPI Silikon 1000 mm	1050	0,164	63	0,164	2
Passavant	Bioflex	IV HPI EPDM 1000 mm	1050	0,164	63	0,164	2
Passavant	Bioflex	II Silikon 1000 mm	1105	0,168	70	0,168	3
Passavant	Bioflex	II EPDM 1000 mm	1105	0,168	70	0,168	3

Fig. 106: Data Bank Aerators

The data records are displayed depending on the selected aerator type. If you have also selected tube diffusers above, the data records for the tube diffusers are displayed.

The aerator data is transferred to the dimensioning of the aeration system and the display of the aeration. A feedback for the calculation of the air volume does not take place. In the form for dimensioning the ventilation according to M 229-1, an SSOTR is specified. This SSOTR will usually differ from the value in the aerator database. If you want to reconcile this, you have to go back to the aeration form and adjust the SSOTR yourself according to the aerator database.

Further aeration design is available through the **Equipment** option. Here the distance of the lattices from the tank wall and the distance between plugs and discs may be varied.

Details for Header Pipes

Distance to Wall  m

Distance of Tubes  m

Distance of Discs  m

mixers

distance behind  m

distance in front of mixer  m

Cancel OK

Fig. 107: Form for Construction through according button

For example a more uniform distribution of discs on the tank base may be obtained through this option. For narrow circular tanks, for example small compact tanks, it may be useful to reduce the distance between the lattices and the tank wall.

## Output

Click on **Output** to update the graphical display after changing data in the windows for **Construction** or **Determining lattices**.

## Mixing Devices

Combined mixing and aeration defines the introduction of the required oxygen into the activated sludge tank and at the same time the maintenance of the activated sludge suspension by means of aeration. An additional mixing device is unnecessary. Mixing devices are installed in the case of separate mixing processes.

## Combined Mixing and Aeration

In pure nitrification operation the circulation may take place through the aeration only. In this case extended periods without aeration must be avoided in the reactor. In the past it has been demonstrated that population equivalents above 600 require mixing devices to avoid deposition of material in the rim areas.

## Aeration Pulses

In the non-aerated phase, the sludge can also be kept in suspension by aeration pulses. Certain conditions must be met for this.

The aeration elements must be distributed so evenly in the basin that the sludge can be kept in suspension by area-wide aeration in all areas of the basin. One measure of the area of the aerators is the density of coverage. The required covering density for circulation by means of aeration pulses depends on the geometry of the aeration elements used and must be specified and guaranteed by the aerator supplier. Usual covering densities are between 12 and 20 %.

The standard DWA-M 229-1 /59/ provides an approach for calculating the amount of air required for circulation.

$$Q_L = \frac{P_{BB}}{2,72} \frac{(1,013 + 98,1 \cdot \frac{h_D}{2})}{1,013 \cdot h_D} * \frac{273}{273 + T_W} \left[ \frac{W}{m^3_{BB}} \right]$$

$P_{BB}$	Specific mixing energy in the aeration tank	[m <sup>3</sup> N/h]
$h_D$	Immersion Depth	[m]
$T_W$	Decisive water temperature in the aeration tank	[m]

One supplier (Aqua Consult, 18.01.2022) gives a guide value of 1.8 [Nm<sup>3</sup>/(m<sup>2</sup>BB x h)].

## Notes on technical design

### Wide-area aeration with circulation by impulse aeration

The required frequency and duration of impulse aeration depends on the sludge settling velocity or ISV. The impulse aeration should start again at the latest when the bottom concentration reaches approx. 8 g/l. This value can be determined using formula 6-1 from A131. The duration of impulse aeration depends on the slip velocity of the air bubbles and the water depth.

The slip velocity of the air bubbles is about 20 cm/s. The impulse aeration should be three times the duration of the rise time of an air blower.

Regarding the duration of pulse aeration, an aerator manufacturer (Messner, 18.01.2022) recommends as follows:

The duration of aeration must be set on site by eye. After the start of the pulse aeration, it takes a while until the bubble carpet appears evenly on the surface of the water. This bubble carpet should be uniform and clearly visible on the water surface for at least 10 seconds.

### Separate Mixing

The circulation is maintained through mixing devices selected from the data bank. Enter the number of mixers into the input field **Number of Mixers**. One mixer for each chamber or line is preselected by the program.

For example one mixing device per activated chamber is present when three mixing devices are suggested in the input field for the **Number of mixing devices** and when three activated chambers were selected.

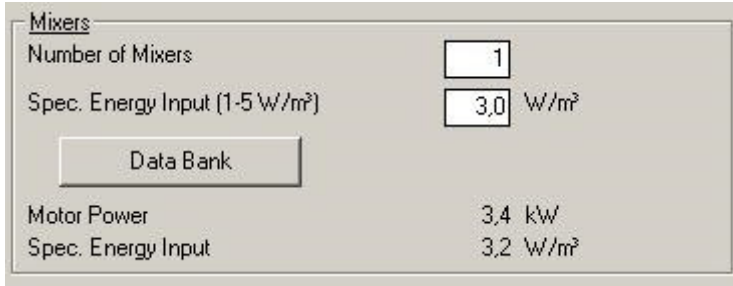

Mixers	
Number of Mixers	1
Spec. Energy Input (1-5 W/m <sup>3</sup> )	3,0 W/m <sup>3</sup>
<input type="button" value="Data Bank"/>	
Motor Power	3,4 kW
Spec. Energy Input	3,2 W/m <sup>3</sup>

Fig. 108: Selecting the mixing device

See the chapter on data banks for details on data bank function and operation.

The ATV A 226 /58/ suggests an energy input of 3 - 8 W/m<sup>3</sup> by the mixing device. Lower values are sufficient for favourable tank types. The selection of a lower energy input should be co-ordinated with the mixing device manufacturer. Suggestions for arrangement and design are readily carried out by the supplier.

#### **Technical Information:**

It is recommended to use slow circulating mixers for mixing the activated sludge if the tank measurements allow. These mixers have large propeller diameters and are more economic than fast rotating mixers. The energy consumption of the mixers strongly influence the energy costs as the mixing devices are generally operated around the clock.

In the Aeration form the mixer data bank lists several slow rotating mixers of established manufacturers/ companies.

In the evaluation of the operation costs the major part of the energy costs are the costs for aeration. Therefore the aeration system should be carefully designed. A uniform distribution of the aeration over the tank base surface improves the economy of the aerators. A fine tuning of the blowers improves their efficiency.

### **Surface Aeration**

Membrane aeration or surface aeration may be selected for oxygenation. AQUA DESIGNER offers two different sets of machinery for the surface aeration that is the surface mechanical aerator with vertical or horizontal axis. For the vertical axis aerator the use in mixing chambers or circulation systems is defined.

### **Required Oxygenation**

The required oxygenation is evaluated from the ratio of oxygen transfer capacity to BOD<sub>5</sub>-load related to the volume. This value allows the calculation of the required energy density and thus, the selection of the aeration machinery.

Required oxygenation:

BITControl	AQUA DESIGNER 9.2 - Manual	Seite: 179 von 314
	7 Dimensioning	Version: 92-00

$$OCA = \frac{OB_{Schmutzwasser}}{V_{AT}} \left[ \frac{kgO_2}{m^3 * h} \right]$$

The required values are evaluated for three different cases based on the recommendations of Wagner [28/,. The desired case is selected with the menu bar options.

Evaluating the required oxygenation in different operating states:

**Rotor in the tank with circulating flow:**

Oxygen transfer capacity:

$$OCA = 11,75 + 1,40 * LD \left[ \frac{gO_2}{m_{BB}^3 * h} \right]$$

Oxygen transfer efficiency:

$$ON10 = 1,97 - 0,0058 * LD \left[ \frac{kgO_2}{kWh} \right]$$

**Surface mechanical aerator with vertical axis in the tank with circulating flow:**

Oxygen transfer capacity:

$$OCA = -2,05 + 2,58 * LD \left[ \frac{gO_2}{m_{BB}^3 * h} \right]$$

Oxygen transfer efficiency(statistically unproved):

$$ON10 = 2,36 - 0,0121 * LD \left[ \frac{kgO_2}{kWh} \right]$$

Surface mechanical aerator with vertical axis in the mixing chamber:

Oxygen transfer capacity:

$$OCA = -10,73 + 1,96 * LD \left[ \frac{gO_2}{m_{BB}^3 * h} \right]$$

Oxygen transfer efficiency:

$$ON10 = 1,41 + 0,0055 * LD \left[ \frac{kgO_2}{kWh} \right]$$

The above cases were statistically evaluated and thus, represent average values for

different methods of aeration under the different given conditions.

### Selected Oxygenation

After evaluating the required oxygenation there is the possibility to enter a value of your own choice, for example on the base of operational experience. The aeration machinery is calculated based on the selected oxygenation. Enter the desired number of aeration sets. In following the required capacity for one set is given. For selecting a defined aerator with variable motor power the capacity of the selected aerator may be entered into the field for **Selected capacity per aerator**.

### Leave Form

Leave the form with **OK**. Changes in the input are accepted and saved by the program without using the **Output** button. In this case the graphical display, however, will not show the latest changes.

Leaving the form with **Cancel** the latest changes are not saved.

## 7.9.8 Return Sludge Transport

The recirculation ratio was determined in the form **Basic Data**. The secondary sedimentation is dimensioned with the previously selected recirculation ratio.

In the form **Return Sludge** the machinery for the return sludge transport is selected. The capacity of the selected units is not considered in the dimensioning of the secondary sedimentation tank. It is assumed that the selected recirculation ratio is maintained by automatic control and regulatory mechanisms.

In the form **Return Sludge Transport** three different transport units are offered. The recirculation ratio selected in the form **Basic Data** is displayed. Decide by selecting an option field.

The chapter on Loads also covers control processes and limits for the recirculation ratio.

### Recirculation Rate QRS

The required transport volume is displayed in the window for dimensioning the transport unit. The transport volume results from the recirculation ratio that was entered into the form for Basic Data.

The displayed flow rate is:

$$Q_{RS} = RV * Q_m \quad [m^3/h]$$

The ATV A 131 /39/ guideline, part 4.2.3., offers recommendations for the design of the return sludge recirculation unit.

Horizontal flow secondary sedimentation tank:  $QRS \leq 1,5 * Q_t$

Vertical flow secondary sedimentation tank:  $QRS \leq 2,0 * Q_t$

The ATV work sheet 'A131-Secondary Sedimentation Tanks' adds that for combined wastewater inflow the transport unit should be designed for a maximum flow rate of  $1,0 \cdot Q_m$ . For vertical flow secondary sedimentation tanks the maximum recirculation ratio of  $QRS = 1,0 \cdot Q_m$  can be selected in the design. The pumps should be designed for  $1,5 \cdot Q_m$ .

This should be considered when selecting a transport unit from the data bank. Thus, compared to the displayed flow rate a larger unit should be selected.

## 7.10 Membrane System

The design is based on the DWA standard M 227 from 10/2014 /66/.

The separation of purified wastewater and sludge by membrane modules in the aeration tank or a downstream module tank is of importance for municipal wastewater treatment. Hollow fibre or plate modules are used for this purpose.

The high separation efficiency of the membrane stage has consequences for the pre-treatment. Since substances accumulate in the activated sludge tank, which are retained at the membrane, specific operational problems can occur.

Mechanical pre-cleaning must ensure that coarse and fibrous particles as well as sand and grease are separated.

Pretreatment stages are rakes or screens, aerated grit and grease traps and, depending on the size of the plant, preliminary clarification may be required in accordance with the usual activated sludge processes.

### 7.10.1 Construction Types

Two fundamentally different arrangements of the membrane modules are possible in AQUA DESIGNER based on the M 227. This also results in different permissible denitrification processes.

#### **Separate stage denitrification**

With external dry installed filtration

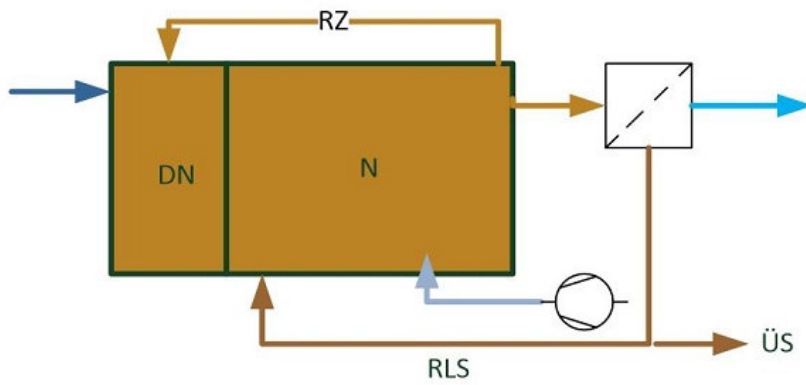

Fig. 109: With external dry installed filtration

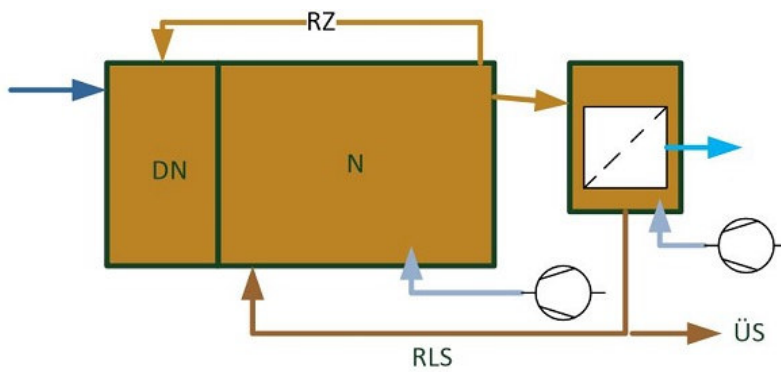

Fig. 110: With external submerged filtration

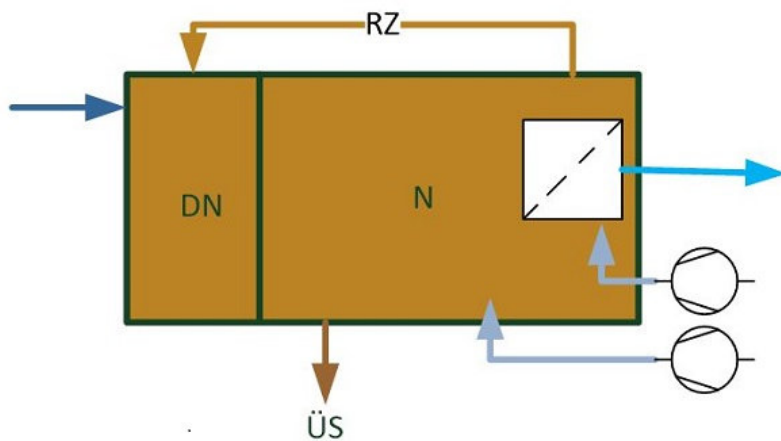

Fig. 111: In the nitrification tank submerged filtration

**Intermittend/simultaneous denitrifikation**



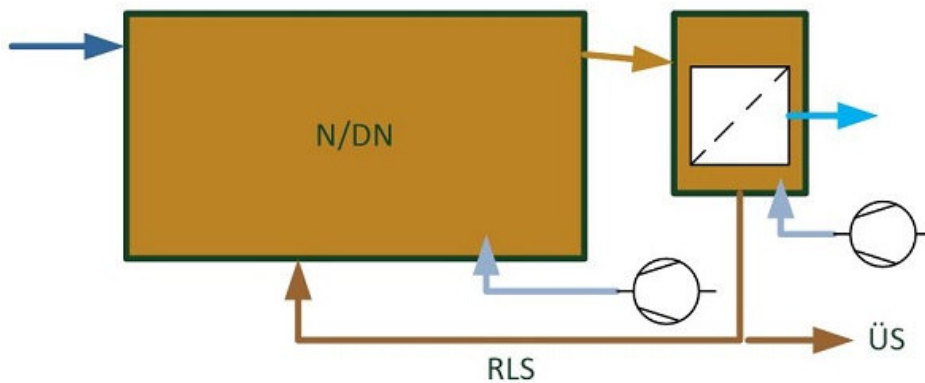

Fig. 112: Intermittend/simultaneous denitrifikation

If you have selected an arrangement of the membrane modules outside the activated sludge tank, you can choose different denitrification methods in the form **Parameters Biology**.

If the membrane modules are suspended in the activated sludge tank, only the upstream denitrification is possible, because then no unaerated operation is possible in the activated sludge tank..

### 7.10.2 Return Sludge and Recirculation

If you have selected upstream denitrification, the selection of the recirculation pump is available in the return sludge form. No recirculation pump is required for intermittent or simultaneous denitrification.

If the membrane modules are installed outside the activated sludge tanks in separate module tanks, return sludge pumps must be provided to return the activated sludge from the module tanks to the activated sludge tank.

The selection of return sludge and recirculation pumps is the last step in the calculation process for MBR plants.

The number of recirculation pumps proposed corresponds to the number of activated sludge tanks selected.

The number of proposed return sludge pumps corresponds to the number of selected module tanks.

### 7.10.3 Design of the Membrane Units

In the first step, a membrane module is selected. Various products are available in a database. As in all other databases, here you have the possibility to add further data sets or to edit or delete the existing data sets.

**Membrane Module**  
MBR-System

Integrated MBR system       Separate MBR system

**Number of Module Tanks:** 4

**Selection Membrane Module**

Manufacturer	Kind of	Type	Length m	Width m	Height m	Membrane Surface m <sup>2</sup>	basic area m <sup>2</sup>	Volume m <sup>3</sup>	Specific Membrane Surface / basic m <sup>2</sup> /m <sup>2</sup>	Packing density m <sup>2</sup> /m <sup>3</sup>
Database	mmf	Platten	0,74	0,72	1,10	70,00	0,53	0,59	131,38	119,44

**Combined Inflow (Q<sub>in</sub>):** 468,75 m<sup>3</sup>/h

**Parameter membrane design**

- Water level above the membranes: 0,10 m
- Water distance under the membranes: 0,30 m
- Transmembrane Pressure: 250 mbar
- Design permeation flux at the end of the usage period: 8,0 l/(m<sup>2</sup>h)
- Max. Suspended Solids: 12,0 g/l

**Parameter Cross-Flow Aeration**

- raw bubbles
- Spec. Oxygen supply: 2,5 gO<sub>2</sub>/(Nm<sup>3</sup>m)
- Spec. Air demand (0,2 - 0,7): 0,3 m<sup>3</sup>/(m<sup>2</sup>h)
- Aeration System-Pressure Loss: 40 mbar

**Blowers**

- Number of Blowers: 4
- Efficiency: 100 %

**Membrane Pump**

- Min. Transportation Height: 2,5 m
- Output: 468,75 m<sup>3</sup>/h
- Number of Pumps: 8
- Transportation Height: 4,0 m

**Result Membrane**

	total	per Tank	
Required membrane surface	58.593,75	14.648,44	m <sup>2</sup>
Number of membrane units	840	210	
Required basic area	447,55	111,89	m <sup>2</sup>
Required Volume	492,31	123,08	m <sup>3</sup>
Required Water Level	1,50	1,50	m

**Results Cross-Flow Aeration**

	total	per Tank	
Required Air Volume	17.578,13	4.394,53	Nm <sup>3</sup> /h
Oxygen Transfer	43,95	10,99	kgO <sub>2</sub> /h
Min. Pressure Height	160	160	mbar

**Blowers Summary:**

- Motor Power: 75,0 kW
- Power Consumption: 50,4 KW
- Air Volume of each Blower: 4410 m<sup>3</sup>/h
- Pressure Height: 300 mbar
- Motor Power, total: 300,0 KW
- Power Consumption, total: 201,6 KW
- Air Volume, total: 17640 Nm<sup>3</sup>/h
- Oxygen Transfer, total: 44,10 kgO<sub>2</sub>/h
- Energy demand of the Cross-Flow aeration: 3,4 Wh/m<sup>2</sup>

**Membrane Pump Summary:**

- Output: 73,80 m<sup>3</sup>/h
- Transportation Height: 5,0 m WS
- Motor Power: 2,0 kW
- Motor Power, total: 16,00 kW
- Output, total: 590,40 Nm<sup>3</sup>/h

Fig. 113: Form Membrane Module

If you have selected a membrane module, the number of module units, the space required and the process variables for cross-flow aeration and permeate discharge result from the selection and the inflow.

### Design Parameters

Filter area per filtration unit	240 – 2.880	m <sup>2</sup> /FE
Specific filter area per footprint in installed condition "Foot Print"	70 – 180	m <sup>2</sup> /m <sup>2</sup>
packing density $A_{Mem, spez}$ of the modules in installed condition	15 - 75	m <sup>2</sup> /m <sup>3</sup>
Required water depth of the membrane tanks	2,5 – 5,0	m

Typical values from the M 227 and market research are provided in the database.

## Required Membrane Aerea

$$A_{\text{Mem}} = Q_{\text{bem}} / V_{\text{FE,bem}} \quad \text{m}^2$$

$A_{\text{Mem}}$	required membrane aerea	$\text{m}^2$
$Q_{\text{bem}}$	design water flow	L/h
$V_{\text{FE,bem}}$	Design permeate flux at the end of the lifetime	L/( $\text{m}^2\text{xh}$ )

The flux is decisive for the required membrane surface. Here, DWA M 227 of October 2014 recommends in chapter 11 an average flux for the annual mean of less than 10 L/( $\text{m}^2\text{xh}$ ). A mean flux of 5-6 L/( $\text{m}^3\text{xh}$ ) is recommended. Now the design inflow  $Q_m$  and the annual mean inflow  $Q_{t,aM}$  must be considered for the measurement.

Membrane technology and thus also the flux rate have of course developed further in the meantime (2021), so that on the one hand the average flow rate should be checked for the design, but on the other hand the current membrane properties should also be taken into account.

The technical discussion results in flux rates of 12 - 22 L/( $\text{m}^2\text{xh}$ ) for 2021 in real applications. See also /68/ and /69/.

In AQUA DESIGNER, the design flux  $Q_{\text{Bem}}$  is queried first. This value is the highest inflow, i.e. the mixed water inflow  $Q_m$  specified under "load". In the case of a separate system,  $Q_m = Q_t$  (dry weather). This value is to be selected according to the state of the art and may be higher than the values recommended in M 227. After "Calculate" has been executed, it is checked which flux results for the mean annual flow  $Q_{t,aM}$ . This value is displayed in the result window "Result membrane".

## Mimumum volume of the membrane tanks

$$V_{\text{MB,min}} = A_{\text{Mem}} / A_{\text{Mem,spez}} \quad \text{m}^3$$

$V_{\text{MB,min}}$	Mimumum Volumen	$\text{m}^3$
$A_{\text{Mem,spez}}$	Package Density	$\text{m}^2/\text{m}^3$

## Required Air Volume for Cross-Flow-Aeration

$$Q_{\text{Air}} = q_L \text{ m}^3/\text{m}^2/\text{h} * A_{\text{Membrane}} \text{ m}^2 \quad [\text{m}^3/\text{h}]$$

## Selection of Pumps and Blowers

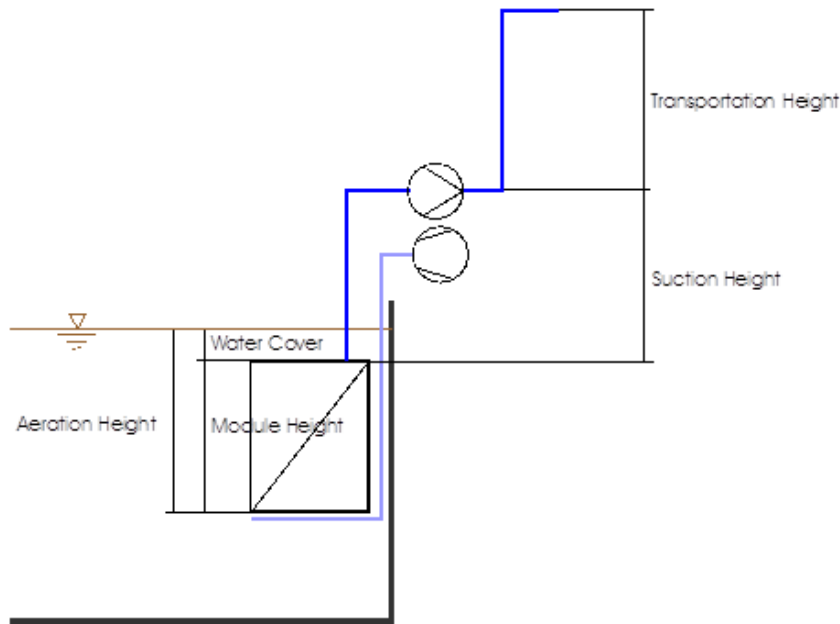

Fig. 114: Selection of Pumps and Blowers

### Counter Pressure of the Blowers

Aeration depth + losses of pipes and aerators

### Suction height of the permeate pumps

Trans membrane pressure + suction height + pipes losses  
+ transportation height [m]

### Energy input for the cross flow aeration

$$El_{CF} = \frac{\text{Power Consumption [kW]} * 1.000}{AMem [m^2]} \left[ \frac{Wh}{m^2} \right]$$

### Multiline

The multi-linearity of the membrane module stage is requested here. If modules have been selected that are suspended in the aeration tanks, the same number of aeration tanks is specified later when the aeration tanks are defined.

If the modules are placed in separate tanks, the number of aeration tanks is freely selectable. If in this case several tanks are selected, the selection box **Multiline** must be activated in **Options - Operation**.

## 7.10.4 Design of the Activated Tanks

The design is generally carried out in accordance with DWA-A 131 (2016) /2/ .

The oxygen or air input is calculated according to DWA-M 229-1 /59/.

## High MLSS Concentrations

At high suspended solids concentrations of between 5 and 20 kg/m<sup>3</sup>, the rheological properties of the sludge-wastewater mixture change increasingly. This has an effect on the oxygen input.

The oxygen input changes with increasing MLSS concentration in the activated sludge tank. The  $\alpha$  value decreases significantly. The data sheet M 227/66/ recommends a maximum value of 0.5.

Since the  $\alpha$  value is of great importance for the assessment of economic efficiency, reference should also be made here to current literature. Wagner et. al. /38/ have determined more favourable  $\alpha$  values than recommended in the leaflet during investigations in large-scale plants. The reason given for the differences is the different conditions in pilot plants and large-scale plants.

MLSS kg/m <sup>3</sup>	9,5	11	14
$\alpha$ -Value	0,7	0,7	0,5

Table 1: MLSS and  $\alpha$ -Value / KA Rödingen

MLSS kg/m <sup>3</sup>	7	9	17
$\alpha$ -Value	0,7	0,6 - 0,7	0,3 - 0,5

Table 2: MLSS and  $\alpha$ -Value / Markranstädt

## Overflow Velocity

The overflow velocity is not included in the design approaches. It can be said qualitatively that the greater the overflow velocity, the greater the cleaning effects for the membranes.

## Active Volume

Please note, that you can decide whether the membrane module is active for the biological processes or not. This affects on the bioreactor volume.



Abb. 1: Required total volumes for active/inactive module volume

### 7.10.5 Disinfection

Membrane filtration achieves wastewater that is largely free of pathogens. This only applies if short circuits between purified and unpurified wastewater are avoided. If the purified wastewater is used directly, it is essential to check its hygienic condition. A guarantee for sufficiently low bacterial counts cannot be given even with the membrane activated sludge process.

## 7.11 Sequencing Batch Reactor

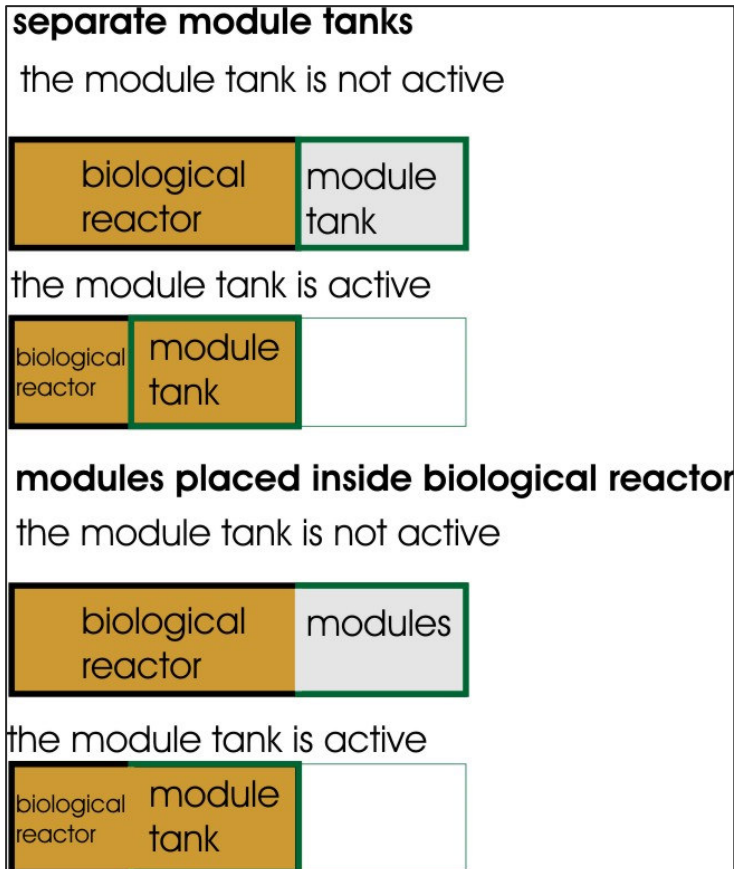
Basis for dimensioning Sequencing Batch Reactors is primarily the guideline ATV M210 "Belebungsanlagen im Aufstaubetrieb" ("Activated sludge wastewater plants with batch operation") published in September 1997.

Furthermore information and recommendations of companies constructing sequencing batch plants and other publications were considered.

For dimensioning the sequencing batch reactor the volume must be calculated first based on the ATV A 131 /39/ guideline. The computation is described in detail in the

chapter on 'Continuous Flow Activated Sludge Wastewater Plant'

The work sheet M210 is applied on plants designed for population equivalents larger than 50.

### 7.11.1 Process and Operational Variations

Sequencing Batch Reactors may be operated in different ways.

#### Batch Operation without preceding Reservoir/Storage Tank

Multiple tanks are required in the case of no available reservoir/storage tank to guarantee the continuous reactor feed from the inflowing wastewater. With this method no wastewater flows into the reactor in particular during sedimentation and outflow intervals.

#### Batch Operation with preceding Reservoir

A preceding reservoir/storage tank offers the convenient opportunity to design the operation in one cycle. High organic particle concentrations are achieved in the start interval through short-time input, thus, improving sludge properties and enhancing respiration.

Improved results from denitrification are achieved when the wastewater progresses in multiple batches.

#### Variation of Method

Wastewater plants may be designed on the basis of constant inflow volume or constant cycle period in addition to the method of input. The design based on constant cycle period has been widely accepted in practice as it offers transparency during operation. Particularly with multiple tanks the current status of each tank is always known.

### 7.11.2 Cycle Period

The hydraulic detention period may be specified as the ratio of the hydraulic detention period in continuous flow wastewater plants. (Equation 4, work sheet M210)

$$t_Z = \Theta_H \cdot f_A \quad [h]$$

$t_Z$	Cycle period	$h$
$\Theta_H$	Hydraulic detention period in the continuous flow activated sludge reactor	$h$
$f_A$	<i>Exchange ratio</i>	

The volume exchange ratio is the ratio of the removed volume during one cycle to the reactor volume with maximum fluid level.

$$fA = \frac{\Delta V}{VR}$$

The wastewater inflow per day must be treated in the present reactors determining the required single reactor volume.

The cycle phases are entered into the form **Reactor Volume**.

## Period

The cycle period for storm weather and dry weather conditions are entered. The required hydraulic volume depends on the inflow. The required hydraulic volume is reduced when a shorter cycle period is accepted for combined wastewater inflow. The result window displays the unfavorable volume from the calculation of storm weather and dry weather cycle period.

## Period of anaerobic Phase

An enhanced biological phosphate removal is achieved by including an anaerobic cycle phase as for continuous flow plants. The period of the anaerobic phase in the sequencing batch reactor is selected based on the recommendations of Boll for continuous flow wastewater plants.

## Detention period before Sedimentation

A detention period before sedimentation is required for the reactor contents after the end of the reaction cycle. It is therefore useful to include a retardation period before the start of the sedimentation period.

## Period of Sedimentation

The period of sedimentation is determined from practical experience. From the sedimentation line you can review the selected period of sedimentation.

The rate of descent is selected with the field **sedimentation line**.

The program will warn you about inadequate safety limits in the distance between water and sludge level when the sedimentation period is selected too short.

## Period of Clarified Water Removal

The period for clarified water removal is based on practical experience. It is among others dependant on the utilized outflow system.



## Length of Retardation Period

You may include retardation periods into the computation and dimensioning when for safety reasons or others the start of each following cycle should not immediately commence after the end of the previous cycle.

### 7.11.3 Reactor Volume

#### Generell

$$V_R = \frac{Qd \cdot \Theta H}{nR} = \frac{Qd \cdot tZ}{n \cdot 24 \cdot fA} \quad [m^3]$$

For combined wastewater inflow the cycle periods for storm-weather and dry-weather conditions are entered into the form for **Reactor Volume**. The program will continue to calculate with the most unfavourable volume result.

Shorter cycle periods are selected for the storm-weather condition than for the dry-weather condition in the case of combined wastewater lines. Thus, deficiencies in the wastewater clarification process are accepted compared to the dry-weather condition.

The operation status of the dry-weather condition additionally to the storm-weather condition is always documented. The documentation is found in the form for **Basic Construction Data** based on the actually selected tank measurements.

#### Sludge Age

The required sludge age is calculated based on the ATV A131 guideline, see Nitrification and Denitrification 66

Sequencing batch wastewater plants are correlated to wastewater plants with continuous flow operation and pre-set/preliminary denitrification. Sequencing batch reactors with continuous flow and intermittent denitrification are correlated to continuous flow wastewater plants with simultaneous denitrification and thus computed correspondingly.

The computation result based on the A131 guideline is displayed in the form for **Reactor Volume**.

#### Volume

A relation between the computation of continuous flow activated sludge wastewater plants and sequencing batch plants results from cycle period and reaction period.

$$n \cdot V_R \cdot TS_R = (V_{AT} \cdot TS_{AT}) \cdot \frac{tZ}{tR} \quad [kg]$$

SS <sub>AT</sub>	Dry solid matter concentration	kg/m <sup>3</sup>
SS <sub>R</sub>	Dry solid matter concentration for SBR	kg/m <sup>3</sup>
V <sub>AT</sub>	Volume based on A131	m <sup>3</sup>

VR	Volume for SBR	$m^3$
tZ	Total cycle period	$h$
tR	Reaction period	$h$
n	Number of reactors	

The above equation results in the same biomass for the SBR-plant as for the continuous flow wastewater plant offering comparable biological conditions.

As a second precondition the plant volume must meet the hydraulic conditions. The maximum required volume for maximum inflow conditions must be used in the computation.

### Hydraulic required Volume

$$VR = \frac{\int_0^t Q_{\max} dt}{fA, \max} \quad [m^3]$$

The biological required volume increases with decreasing cycle period while the hydraulic required volume decreases. Thus, it is useful to approximate both the volumes by adapting the cycle period. In AQUA DESIGNER this is achieved in short course.

$fA, \text{vor} = 0,4$

The hydraulic volume is precalculated with the suggested factor favor based on the M210 guideline.

The result of greater volume derived from the biological and hydraulic calculation is used in the following computation. The dry solid matter concentration for the activated sludge tank must be recalculated for a possible unfavorable hydraulic volume.

$$MLSS(\text{hydraulic}) = MLSS(\text{biological}) * \frac{VR(\text{biological})}{VR(\text{hydraulic})} \quad \left[ \frac{kg}{m^3} \right]$$

### Volume Exchange Ratio

For the hydraulic calculation the validity of the preselected volume exchange ratio must be reviewed. A minimum distance is required from the clear water outlet to the sludge level.

AQUA DESIGNER assumes a constant outflow capacity of the clear water outlet during the total selected outflow period.

Sludge level after the settling process is completed:

$$h_s = h_w * \frac{TSR * ISV}{1000} \quad [m]$$

hs	sludge level	$m$
hw	maximum waterlevel	$m$

ISV      sludge volume index      ml/g

### Sedimentation Line

The total volume for dry weather and rain weather was determined on the basis of the minimum volume and the hydraulic, respectively the exchange volume. The MLSS in the minimum volume MLSS<sub>min</sub> is converted into MLSS<sub>R</sub> for both load cases. MLSS<sub>R</sub> refers to the total volume.

Dry solids concentration TSR related to the reactor volume.

$$TSR = \frac{V_{\min}}{V_R} * TS_{\min} \quad [kg]$$

TSR = MLSS <sub>R</sub>	Dry solids concentration in the reactor, related to VR	kg/m <sup>3</sup>
V <sub>min</sub>	Minimum volume	m <sup>3</sup>
VR	Total volume	m <sup>3</sup>
TS <sub>min</sub>	Dry solids concentration in the minimum volume	kg/m <sup>3</sup>

Thus you get different results for dry weather and rain weather conditions

Exchange ratio:	$f_{A,TW}, f_{A,RW}$
Dry solids concentration in the reactor:	$T_{SR,TW}, T_{SR,RW}$
Reactor Volume:	$V_{R,TW}, V_{R,RW}$

ISV is chosen on the basis of sludge characteristics or experience. The specification in AQUA DESIGNER is suitable for typical municipal wastewater. With the sludge concentration in the reactor and ISV, the sludge level, which sets after completion of the settling process results.

Relative sludge level at the end of settling:

$$h_{S,e} = \frac{TS_R * ISV}{1000}$$

h <sub>S,e</sub>	relative sludge level at the end of settling, bezogen auf HW,0	
TSR	Dry solids concentration in the Reactor, related to VR	kg/m <sup>3</sup>
ISV	Sludge volume index	ml/g

The time course of the sludge level is decisive for proving the safety margin between clear water discharge and sludge level.

Relative sludge level at the end of the phase:

$$HS = HW,0 * [hS,e + (1 - hS,e) * e^{-a(t - tFlock)}] \quad m$$

HS	absolute sluge level	m
HW,0	absolute sludge level at the beginning of settling	m
h <sub>S,e</sub>	Relative sludge level after total settling	
a	Parameter of the e-Funktion	1/h
t <sub>Flock</sub>	Floculation time	
t	Time after reaction phase	h

Parameter for settling:

$$a = \frac{725}{HW,0 * \left(1 - \frac{VSV}{1000}\right) * (VSV - 100)} \quad \frac{m}{h}$$

a	Parameter	m/h
HW,0	absolute sludge level at the beginning of settling	m
VSV	Sludge Volume	l/m <sup>3</sup>

Proof:

The clear water level HKW must be at least 0.15 HW and 0.4 m.

The sinking line or the distance between the clear water outlet and the sludge level is proven for dry weather and rainy weather.

The distance at the beginning of the clear water outlet and at the end of the clear water outlet is checked.

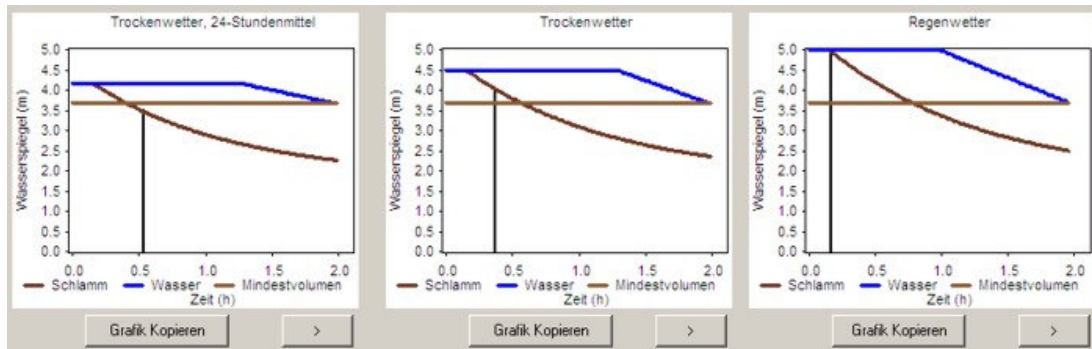

Fig. 115: Proof for dry and rainy weather

### Denitrification

Denitrification is established by unaerated periods within the reaction phase. Simultaneous denitrification is present when sequencing batch reactors are continuously operated with intermittent aeration.

There should be no initial aeration when multiple tanks are operated. The nitrate present in the reactor then is reduced comparable to the preset *vorgeschaltete* denitrification process.

Best results are achieved with the sequencing batch method. Multiple batches result in greater effectiveness for the denitrification.

For equal sized batches tN and constant periods tD the following applies:

Reaction period:

$$tR = z * (tD + tN) \quad [h]$$

$$tD + tN \leq 2 \text{ h}$$

Reaction period, denitrification period:

$$tD = \frac{VD}{VAT} * \frac{tR}{z} \quad [h]$$

Available ammonium concentration:

$$NH4-NNit = TKNo - N\ddot{U}S - orgNe \quad [mg/l]$$

Based on the data to A131 and the university algorithm it is:

$$N\ddot{U}S = ca. 0,04 * AT5 \quad [mg/l]$$

$$orgNe = 2 \quad [mg/l]$$

The nitrate outflow concentration results from a mass balance:

$$NO3 - Ne = NH4 - NNit * \frac{\Delta V}{z * (V_{min} + \Delta V)} \quad \left[ \frac{mg}{l} \right]$$

Or from:

$$fA = \frac{\Delta V}{V_{min} + \Delta V}$$

$$NO3 - Ne = NH4 - NNit * \frac{fA}{z} \quad \left[ \frac{mg}{l} \right]$$

In the above equation the volume exchange ratio for the dry weather condition is used being the most common operating condition.

This mass balance is based on the following:

- end of the denitrification phase with  $NO3-N = 0$ .
- end of the nitrification phase with  $NH4-N = 0$ .
- no denitrification during the nitrification phase.
- no nitrification during the denitrification phase.

The form **Nitrogen removal** reviews the denitrification capacity based on the A 131 /39/ guideline. The program assesses the denitrification capacity for completely reducing the nitrate with the selected design of the cycle reaction period.

$$NO3-ND = NH4-NNit - NO3-Ne \quad [mg/l]$$

DWA-A131, 1991:

$$\frac{NO3 - ND}{BOD5} = 0,8 * \frac{0,75 * OUC}{2,9} * \frac{VD}{VAT} \quad \left[ \frac{kgN}{kgBOD5} \right]$$

$$\frac{VD}{VAT} = \frac{tD}{tR}$$

$$NO_3 - ND = 0,8 * \frac{0,75 * OUC}{2,9} * \frac{tD}{tR} * BOD_5 \quad [kgN]$$

Fig. 116: Form for nitrogen removal

The number of equal volume wastewater batches added during one reaction phase is set when entering the number of batches. This practically presents preset denitrification ( vorgeschaltete Denitrification) based on the above described preconditions for complete nitrification and denitrification. The right window presents the evaluated denitrification capacity.

A warning appears when the denitrification capacity for the available denitrification volume is insufficient.

### Oxygen Demand

The oxygen demand is calculated as for DWA-A 131 and DWA-M 229-1 /59/. The peak factors are used accordingly to the cases in A 131.

The oxygen consumption OVh [kg/h] is converted from continuous to the batch process.

$$SOTR = \frac{fd * \beta * CS,20 * fST,ST}{\alpha * (fd * \beta * Cs, T * (Patm/1013) - Cx) * \theta^{(T - 20)}} * OVh * f_{int} * f_{SBR} * 24 \dots [kgO_2 / h]$$

$$f_{SBR} = \frac{1}{mZ * tR}$$

mZ	Number of cycles	
tR	Duration reaction phase	
β	Salt factor	
fSt,ST	Salt factor 2	
cS,20	Oxygen saturation at 20°C	[mg/l]
cS,T	Oxygen saturation at design temperature	[mg/l]
Cx	Oxygen concentration in operation	[mg/l]
θ	Temperature factor, 1,024	

**Sauerstoffeintrag (Gesamt)**  
 Mindestvolumen VBB: 4661 m3  
 Gewähltes Volumen VBB,ist: 4661 m3

**Wassertiefe h<sub>BB</sub>**: 2,1 m  
**Einblastiefe h<sub>D</sub>**: 4,7 m  
**Tiefenfaktor f<sub>D</sub>**: 1,23  
**Sauerstoffsättigung bei 20°C c<sub>S,20</sub>**: 9,10 mg/l

**Faktoren Druckbelüftung**: 2,1 m  
**Faktoren Oberflächenbelüftung**: 2,1 m

**Höhe der Anlage über NN**: 380 m  
**Spezifische Sauerstoffausnutzung SSOTR**: 19,0 gO<sub>2</sub>/(m<sup>3</sup>m)  
**Salzfaktor β**: 1,0  
**Salzfaktor f<sub>SL,St</sub>**: 1,0  
**relative Luftfeuchte J**: 0,40  
**Druckverlust auf der Ansaugseite DP**: 20 mbar  
**Ansaugtemperatur**: 30 °C

**Lastfälle**  
 Lastfall: 0 1 2 3 4 v1 5 v2  
 Bemessung Durchschnitt maximal Minimal Prognose Winter

Belastung	%	100,0	80,0	100,0	80,0	100,0	100,0
Abwassertemperatur T	°C	12	15,0	20,0	15,0	15,0	10,0
Trockensubstanzkonzentration TS <sub>BB</sub>	kg/m <sup>3</sup>	5,00	5,00	5,00	5,00	5,00	5,00
Stickstoff im Zulauf CTKN,ZB	mg/l	56,8	56,8	56,8	56,8	56,8	56,8
Nitrat-N im Zulauf SNO <sub>3</sub> ,ZB	mg/l	0,0	0,0	0,0	0,0	0,0	0,0
Ablaufkonzentration Ammonium SNH <sub>4</sub> -N,AN	mg/l	0,0	0,0	0,0	0,0	0,0	0,0
Ablaufkonzentration organisch Sorg,N,AN	mg/l	2,0	2,0	2,0	2,0	2,0	2,0
<b>Nitrat-N (Ablauf) SNO<sub>3</sub>,AN</b>	<b>mg/l</b>	<b>6,0</b>	<b>6,0</b>	<b>6,0</b>	<b>6,0</b>	<b>6,0</b>	<b>6,0</b>
Gesamtschlammalter t <sub>S</sub>	d	10,6	14,6	12,0	14,6	11,1	0,0
Erforderliches aerobes Schlammalter t <sub>S,a</sub>	d	7,30	5,44	3,33	5,44	5,44	0,00

**Stoßfaktoren**  
 Stoßfaktor für Kohlenstoffatmung f<sub>C</sub>: 1,00  
 Stoßfaktor für stickstoff f<sub>N</sub>: 1,00

**Belüftungszeit**  
 Denitrifikationsverhältnis VD/V<sub>BB</sub>max: 0,311  
 x: 1,009  
 Belüftungszeit t<sub>L</sub>: 11,37

**Sauerstoffbedarf O<sub>2</sub>,D**: 43,30  
**O<sub>2</sub>-Verbrauch für Nitrifikation O<sub>2</sub>,N**: 74,90  
**O<sub>2</sub>-Verbrauch für Denitrifikation O<sub>2</sub>,D**: 42,92  
**Sauerstoffbedarf O<sub>2</sub>,h**: 145,77  
**Sauerstoffbedarf O<sub>2</sub>,min**: 126,58  
 Betrieb Sauerstoffkonzentrationen c<sub>x</sub>: 1,50

**Druckluftbelüftung**  
 Grenzflächenfaktor α: 0,85  
 Sauerstoffzufuhr SOTR: 438,29  
**Luftbedarf QL**: 4929,00

**Oberflächenbelüftung**  
 Grenzflächenfaktor α: 0,95  
 Sauerstoffzufuhr SOTR: kgO<sub>2</sub>/h

**Rechtsbereich (Gebläseauswahl 1):**  
 Bemessungsluftmenge, Lastfall 2: 11302,25 m<sup>3</sup>/h  
 Anzahl Gebläse: 4  
 Nennleistung: kW  
 Luftmenge je Gebläse: m<sup>3</sup>/h  
 Gegendruck: mbar  
 Luftmenge für die Auslegung der Membranbelüfter (pro Becken): m<sup>3</sup>/h

**Rechtsbereich (Gebläseauswahl 2):**  
 Reserve Gebläse  
 Anzahl Gebläse: 0  
 Nennleistung: kW  
 Luftmenge je Gebläse: m<sup>3</sup>/h  
 Gegendruck: mbar  
 Luftmenge für die Auslegung der Membranbelüfter (pro Becken): m<sup>3</sup>/h

**Rechtsbereich (Umwälzaggregate):**  
 Anzahl der Rührwerke: 2  
 Leistungsdichte (1-5 W/m<sup>3</sup>): 3,0 W/m<sup>3</sup>

Abb. 2: Aeration SBR-process

### Excess Sludge

The excess sludge results analog to the ATV A131 guideline. The amount of excess sludge is transferred on the cycle phases.

$$V_{WS} * SS_{WS} = \frac{VR * SSR}{tSS} * \frac{tR}{24} \left[ \frac{kg}{Zyklus} \right]$$

The excess sludge production per day is:

$$WS_d = V_{WS} * SS_{WS} * n * mz \quad [kg/d]$$

### Storage Tank

As described above it is favorable to design a storage tank preceding the sequencing batch reactor(s). It is then possible to facilely alter the phases within a cycle for optimizing the nitrogen elimination.

And you can feed in several charges in order to improve the denitrification.

The required storage period is calculated based on the following values.

Storage period:

$$t_R = \frac{t_Z}{n * n_S} - t_F \quad [h]$$

$t_R$	Retention Time of the Buffer Tank
$t_Z$	Cycle Time of the SBR
$n$	Number of Reactors
$n_S$	Number of Feeds
$t_F$	Time of Feed

## Storage volume

The volume for the prestorage tank results from the inflow volume and the required storage/detention time.

$$V_S = \frac{Q_m}{t_R} \quad [m^3]$$

$V_S$	Volume of storage tank	$m^3$
$Q_m$	hourly dry weather inflow	$m^3/h$
$t_S$	storage time/detention time	$h$

## Operation

Select a storage tank in the menu bar **Extras > Storage Tank (SBR)**.

The prestorage tank is only computed after computing the sequencing batch reactors as value data from the latter is required in the computation of the prestorage tank. For example the number of reactors, the cycle period and the number of batches per cycle must be known for computing the prestorage tank.

The required volume for the prestorage tank is displayed after selecting the storage tank (SBR).

In the window for **tank structure** (shape, form, construction) it is now possible to select the tank shape as a circular or rectangular tank with clicking on the according option.

In following it is possible to freely design the dimensions of the tank. It may be designed larger than required for example in the case of necessary adoptions to standardized tank sizes.

Leave the form with **OK**. A documentation of the computation appears. The operation of this surface is in accordance with the general operation of documentation surfaces described in the according chapter.



## 7.12 Completed Computation

The dimensioning of the biological step is completed when the steps of the flow diagram beginning from **Load** and ending in **Excess sludge transport** are completely calculated and marked green.

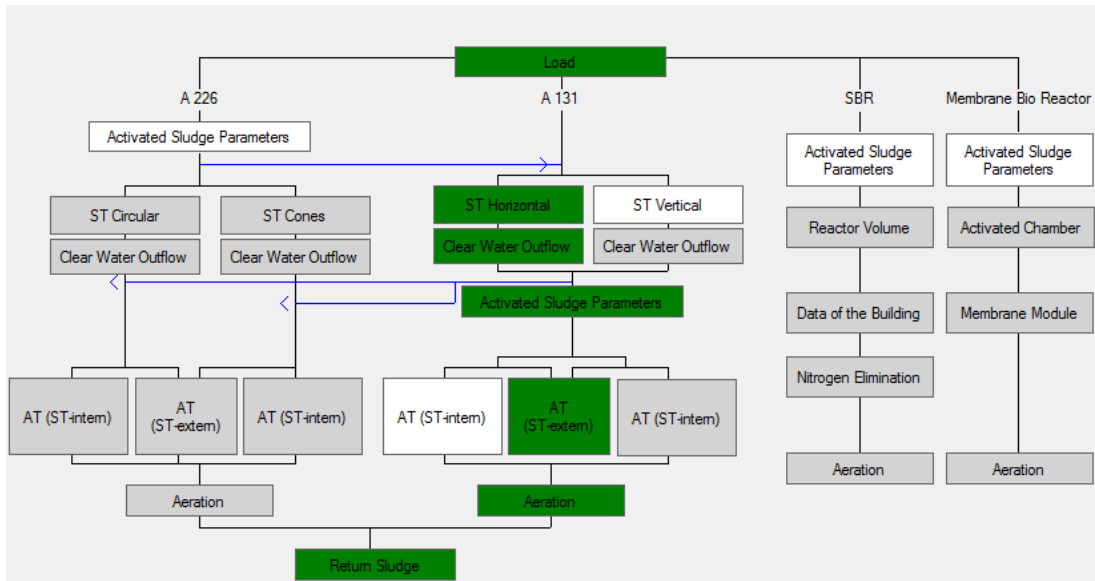

Fig. 117: Main Form with complete calculation

In following all other functions of AQUA DESIGNER are at your disposal.

## 7.13 Grit Chamber Design

Circular and aerated Grit Chambers are included. Aerated grit chambers can be combined with grease chambers.

You reach the dimensioning site via **Selection** in the menu bar.

### 7.13.1 Dimensioning

#### Grit and Grease Chamber

The screen is similar to the one known from the dimensioning of biological stages in AQUA DESIGNER.

You can make calculations for aerated grit chambers, grease traps, and circular grit chambers. The equipment components necessary for the dimensioning such as sand transportation, aerator, grease trap, and sand washer will be calculated or chosen.

After having finished the dimensioning you are able to calculate operating costs, to proof the calculation mathematically, to create an explanatory report, and to print drawings.

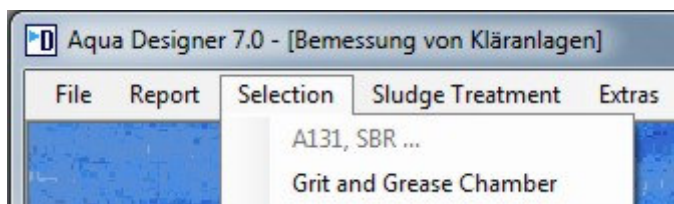

Fig. 118: Menu Selection

Should you be on the screen for the biological stages you can reach the dimensioning for the grit chamber via **Menu > Selection > Grit and Grease Chamber**.

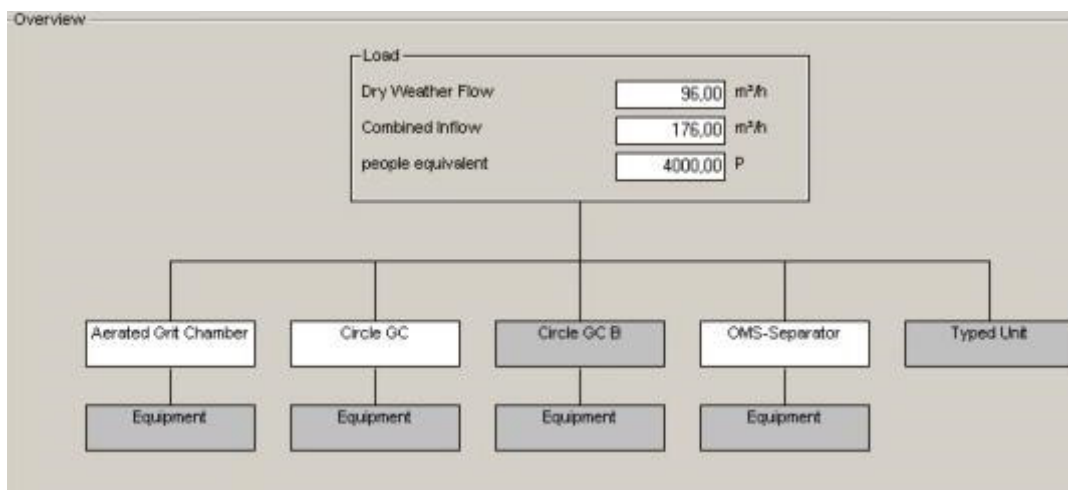

Fig. 119: Screen for different kinds of grease and grit chambers

The documentation is at your disposal as soon as the calculations are made. As it is in the biological dimensioning the calculations for sewage treatment, operating costs, reports, and drawings can be found in the menu bar.

### **Circle Grit Chamber**

The dimensioning of circular grit chambers is more specific to the producer than those of an aerated rectangular grit chamber. Sources in this field are sparse. The following publications are fundamentally based on the research from Kalbskopf from 1966.

Kalbskopf, K.H.: Die Bemessung von Sandfängen unter Berücksichtigung der Strömungsturbulenzen; Kommunalwirtschaft 1966, Heft 9

The waste water is tangentially introduced into a round shallow funnel and flows horizontally through it. The circular stream creates a cross stream with a downward movement on the edges which drags down the deposited matter. The water level drops towards the centre of the circle while the horizontal flow velocity increases. The sand will be deposited in the centre of the funnel and can be centrally extracted.

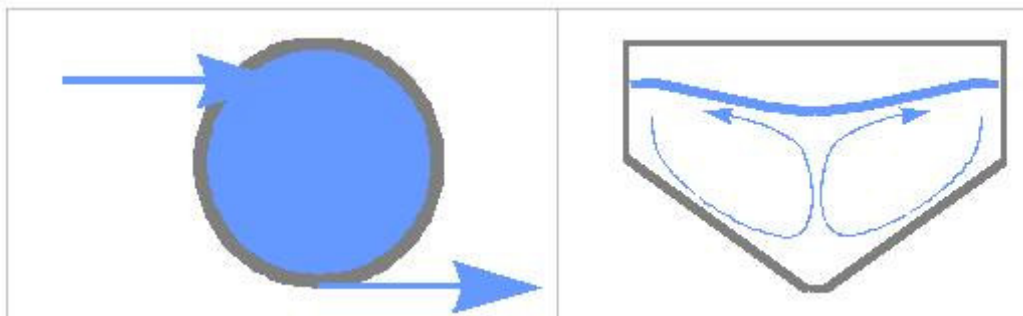

Fig. 120: Stream in Circular Grit Chamber

### **Dimensioning Basis**

#### **Kalbskopf**

Input velocity: < 0.50 – 0.60 m/s

Outlet velocity: < 0.40 – 0.50 m/s

Theoretical retention period without sand accumulation area 30-45s

Outlet base approx. 10 – 15 cm higher than inlet base

With air lift pump: sand accumulation shaft depth = aeratio depth  $\geq$  extraction height over water level + extraction length \* 0.01

#### **ATV Manual Mechanical Waste Water Treatment**

Input velocity: < 0.75 – 1.0 m/s

Outlet velocity: < 0.80 m/s

Theoretical retention period without sand accumulation area 30-45s

Maximum input  $t_R > 25s$

Only one half of the truncated cone like grit chamber area is used to determine the hydraulic retention time. To simplify the calculations of the usable surface area an inner surface area is determined using half the diameter and is then subtracted from the total surface area.

The funnel is designed for a complete dry-weather-flow. The water level only reaches the vertical or cylindrical part of the funnel if there is combined wast water flow.

The recommended funnel slope is 1 : 1.5.

A pile up can be achieved by introducing a following Venturi-channel.

## Handling

You can predefine the number of lines. The waste water input will then be equally distributed to the chosen number of lines.

The sand accumulation shaft is shown on the control screen as being open downwards. The depth of the shaft depends on the chosen sand extractor. The shaft will be deeper than the pumps if air lift pump is chosen. The diameter of the shaft is governed by the necessary area for the extracting machine, the diametral aeration system, and the desired sand storage capacity.

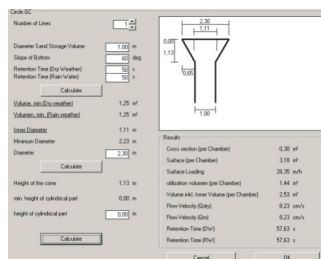

Fig. 121: Screen Circular Chamber

The screen will only be calculated when all steps are gone through. Only then will the results be processed for further steps.

## Aerated Grit Chamber

Aerated grit chambers can be constructed either with or without a grease and floating sludge channel at the side. Sand can be extracted through a suction device or a scrapper. The necessary air demand is governed by the basin's cross section area and length.

The calculation data is summarised below.

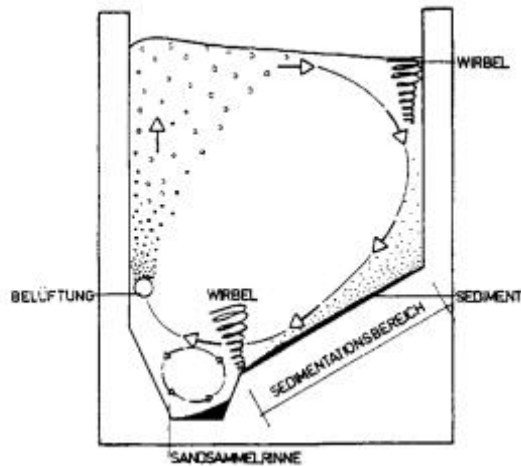

Fig. 122: Cross section of an aerated grit chamber

The dimensioning of aerated rectangular grit chambers with or without grease trap is based on the following literature.

- ATV-Handbuch      Mechanische Abwassereinigung  
Abwassertechnische Vereinigung e.V., Bad Hoenf  
Ernst & Sohn, Berlin, 1996
- M. Boes,            Anordnung und Bemessung der Luftzufuhr von belüfte-  
ten Sandfängen  
Korrespondenz Abwasser 7/90
- A. Stein            Ein Beitrag zur Gestaltung belüfteter Sandfänge  
Korrespondenz Abwasser 4/92
- J. Londong        Beitrag zur Bemessung belüfteter Sandfänge  
Korrespondenz Abwasser 1/88
- ATV-Arbeitsbericht der ATV-Arbeitsgruppe 2.5.1 "Sandfänge"  
im ATV-Fachauschuß 2.5 Absetzverfahren
- Sandabscheideanlagen (Sandfänge und Sandfanggutaufbereitungsanla-  
gen)  
Korrespondenz Abwasser 3/98

Overview over the basic dimensioning process of aerated grit chambers:

horizontal flow velocity	< 0.20 cm/s
width / depth ratio for dry-weather-flow	< 1.0
width / depth ratio for storm-water-flow	< 0.8
cross sectional area	1 to 15 m <sup>2</sup>
basin length	min. 10 times the width, max. 50m
retenion time for storm-water-flow	min. 10 min
aeration depth	30 cm over top of sand accumulation channel
base slope	35 – 45°
specific aeration rate per cross sectional area	0.5 – 1.3 m <sup>3</sup> /(m <sup>3</sup> *h)
whilst having problems with biological phosphate and denitrification	0.1 – 0.2 m <sup>3</sup> /(m <sup>3</sup> *h)

### Dimensioning of Aeration

In the literature, there are different proposals on how to dimension the grit chamber aeration. The above mentioned values are given by the ATV-Arbeitsbericht.

Whereas Stein (34) gives detailed levels of aeration rates per cross sectional area

cross sectional area m <sup>2</sup>	specific aeration rate $\frac{\text{Nm}^3}{\text{m}^3 \cdot \text{h}}$
1.0 – 3.0	0.5 – 0.9
3.0 – 5.0	0.5 – 1.1
> 5.0	0.5 – 1.3

Aeration rates per cross sectional area according to Stein

An empirical equation is given by Londong (35) depending on the kind of aeration system and the aeration depth:

Aeration depth: 0.7 T

Necessary aeration rate for a fine bubble aeration:

$$Q_V = (0,63 + 0,52 * \ln(T_E)^{-0,62}) \quad [\text{m}^3/(\text{m}^3 \cdot \text{h})]$$

Necessary aeration rate for a coarse bubble aeration:

$$Q_V = (0,07 + 0,76 * \ln(T_E)^{-1,33}) \quad [\text{m}^3/(\text{m}^3 \cdot \text{h})]$$

Above mentioned proposals are valid for a width / depth ratio of 0.8.

## Grease Trap

The ATV-Arbeitsbericht gives references on how to dimension a grease trap.

The width of the grease trap can be chosen to be about 0.2 to 0.5 times bSF.

A dimensioning depending on the surface loading rate is possible, too. The surface loading rate should then be  $\leq 25$  m/h.

## Handling

You can predefine the number of Lines. The waste water input will then be equally distributed to the chosen number of Lines.

Aerated Grit Chamber

Number of Lines

Grease Trap

Width Grease Chamber / Width Sand Chamber

Ditch

Width of Groove  m

Depth of Ditch  m

slope of the ditch  deg

Slope of Bottom  deg

Retention Time (Dry Weather)  min

Retention Time (Rain Water)  min

Minimum Volume (Qt)  m<sup>3</sup>

opt. Width  m

Width  m

opt depth (w/h = 0,8)  m

Depth, chosen  m

opt Length (calc. Based of Vmin)  m

Chosen length  m

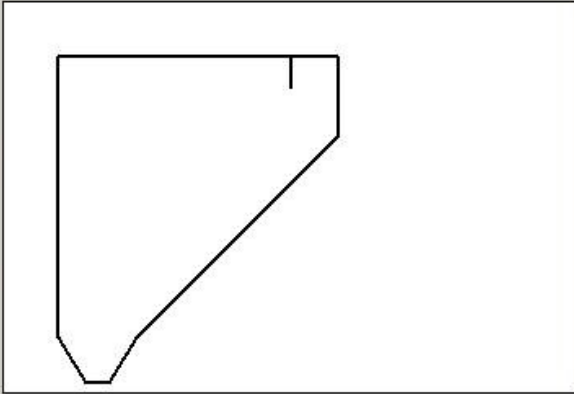

Results

Cross section (per Chamber)	2,20 m <sup>2</sup>
Surface (per Chamber)	22,50 m <sup>2</sup>
Surface Loading	4,00 m/h
Volume (per Chamber)	33,00 m <sup>3</sup>
Ratio Width/Depth	0,83
Flow Velocity (Qdry)	1,14 cm/s
Flow Velocity (Qm)	1,14 cm/s
Retention Time (DW)	21,98 min.
Retention Time (RW)	21,98 min.

Fig. 123: Screen Rectangular Grit Chamber

The grease trap can be either chosen or not. That can be done by ticking the check box **Grease Trap** on or off. Should the grease trap be deactivated then there will be no channel at the side.

Aerated Grit Chamber

Number of Lines

Grease Trap

Ditch

Width of Groove  m

Depth of Ditch  m

slope of the ditch  deg

Slope of Bottom  deg

Retention Time (Dry Weather)  min

Retention Time (Rain Water)  min

Minimum Volume (Qt) 30,03 m<sup>3</sup>

opt. Width 1,50 m

Width  m

opt depth (w/h = 0,8) 1,88 m

Depth, chosen  m

opt Length (calc. Based of Vmin) 13,65 m

Chosen length  m

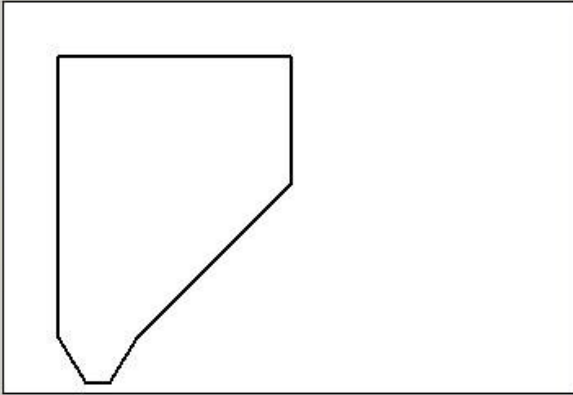

Results

Cross section (per Chamber)	2,20 m <sup>2</sup>
Surface (per Chamber)	20,55 m <sup>2</sup>
Surface Loading	4,38 m <sup>3</sup> /h
Volume (per Chamber)	30,14 m <sup>3</sup>
Ratio Width/Depth	0,83
Flow Velocity (Qdry)	1,14 cm/s
Flow Velocity (Qm)	1,14 cm/s
Retention Time (D'w)	20,07 min.
Retention Time (R'w)	20,07 min.

Fig. 124: Screen Rectangular Grit Chamber; Grease Trap deactivated

The basis for the data can be found above in this chapter.

The screen will only be calculated when all steps are gone through. Only then will the results be processed for further steps.

## 7.13.2 Equipment

### Generell

The screen for choosing the equipment is identical to all different grit chamber types. Each component can either be activated or deactivated.



<input checked="" type="checkbox"/> Aeration Aeration <input type="radio"/> Calc by specific air input <input checked="" type="radio"/> Calc by Formula  <input checked="" type="radio"/> Fine Bubble Aeration <input type="radio"/> coarse bubble Aeration Specific Air Input <span style="float: right;">1,18 (m<sup>3</sup>/h)/m<sup>3</sup></span> <input type="button" value="Calculate"/> Air volume calculated <span style="float: right;">35,70 m<sup>3</sup>/h</span> Air volume chosen <input type="text" value="35,70"/> m <sup>3</sup> /h Number of Blowers <input type="text" value="1"/> <input type="button" value="Data Bank"/> Motor Power <span style="float: right;">2,2 kW</span> Air Volume of each Blower <span style="float: right;">53,00 m<sup>3</sup>/h</span> Pressure Height <span style="float: right;">280 mbar</span>		<input checked="" type="checkbox"/> Grit Transportation Grit Transportation capacity <input type="text" value="30,00"/> m <sup>3</sup> /h <input type="button" value="Grit Transportation"/> <input checked="" type="checkbox"/> Sand Classifier Sand Classifier capacity <input type="text" value="30"/> m <sup>3</sup> /h Motor Power <input type="text" value="0,25"/> kW Result Sand Transportation Sand Concentration for Transport <input type="text" value="5,00"/> % Grit Volume <input type="text" value="12,00"/> l/P/a <input type="button" value="Calculate"/> Daily Grit Production <span style="float: right;">164,38 l/d</span> Daily Transport Volume <span style="float: right;">3,29 m<sup>3</sup>/d</span> chosen transport capacity <span style="float: right;">162 m<sup>3</sup>/h</span> Operation Time of Transport Machine <span style="float: right;">0,02 h/d</span>	
<input type="button" value="Cancel"/> <input type="button" value="OK"/>		<input checked="" type="checkbox"/> Scum Pump Scum Pump capacity <input type="text" value="20,00"/> m <sup>3</sup> /h <input type="button" value="Scum Pump"/> Scum Concentration <input type="text" value="10"/> % Scum Production <input type="text" value="6"/> l/P/a <input type="button" value="Calculate"/> Daily Grease Production <span style="float: right;">82,19 l/d</span> Daily Transport Volume <span style="float: right;">0,82 m<sup>3</sup>/d</span> chosen transport capacity <span style="float: right;">162,00 m<sup>3</sup>/h</span> Operation Time of Transport Machine <span style="float: right;">0,01 h/d</span>	

Fig. 125: Screen Equipment

## Aeration

As mentioned in the dimensioning basis the aeration rate can be chosen either following the ATV-Arbeitsbericht (36) or different empirical proposals. If the empirical proposal after Londong is chosen it can be further distinguished between fine and coarse bubble aeration.

First determine the necessary aeration rate.

You can then choose a fitting compactor from the data base.

## Sand Extraction

First choose the sand extraction rate. The sand extraction rate is not calculated as being continuous, it will rather be done in intervals. The capacity of the sand extraction device has to be chosen according to operational aspects. The extraction rate is mostly around 30m<sup>3</sup>/h.

Afterwards you can choose a compressed air lever, a fitting compactor, or a centrifugal pump respectively.

According to the chosen extraction rate, the calculated amount of sand and the concentration of sand within the extracted material, a daily time of operation for the extraction device can be determined.

## **Circle Grit Chamber**

### **Aeration**

Usually a circular aeration system will be situated within the pump pit of the circular grit chamber. This circular aeration system is loosening the sand on the bottom and cleans it of organic compounds.

The aeration ring is directly situated in the sand accumulation sump. The air leaves the ring through holes. The compressed air is introduced into the grit chamber by means of an air compressor.

The usual aeration rate of a circular grit chambers is approx. 30 m<sup>3</sup>/h.

The aeration can be done continuously in order to keep the water within the circular grit chamber fresh.

Yet, it makes sense to activate the aeration before the extraction process begins, in order to loosening the sand and cleaning it of organic compounds as described above.

### **Sand Extraction**

For sand extraction both centrifugal pump and circular aeration system are possible.

The rotors of centrifugal pumps are quickly worn, even if they are made out of hardened material.

More suitable for the sand extraction are compressed air levers. When using those the circular grit chamber has to be designed respectively, i.e. the aeration depth should be no less than the extraction height plus 10% of the total extraction length. Therefore the sand accumulation sump has to be sufficiently deep.

### **Grease Separation**

Circular grit chambers are usually not designed to separate grease from the rest. Some separation can be achieved, though, e.g. by introducing a scumboard at the outlet or certain constructions which are specific to the constructor. The grease is then pumped to a grease accumulation pit, from where the additional water has to be recirculated into the system.

## Aerated Grit and Grease Chamber

### Aeration

The geometry of the aeration is described within the dimensioning basis. Nowadays membrane aerators are used for the grit chamber aeration. They are put in row and line against the steep wall of the grit chamber.

### Sand Extraction

The sand has to be transported to the sand accumulation sump at the top end of the grit chamber by a scrapper, or the collector pumps the sand-water-mixture directly into the channel at the side of the grit chamber.

### Sand Classifier

The sand will usually be separated from the water in a sand classifier. The remaining water will then be recirculated into the system. When choosing the sand classifier it has to be taken care of that the capacity of the sand extraction device is not higher than the capacity of the sand classifier, i.e. that they have to have similar capacities. Should those capacities differ from each other, you will be notified.

### Grease Extraction

Attached to the grit chamber cleaner is a grease plate, that transports the floating grease from the grease chamber into a grease accumulation pit. The grease is accumulated in the upper section of the pit.

## Sand and Grease Volume

The absolute sand and grease volume can be calculated from the population equivalent and the chosen values for the specific sand and grease volume.

$$\frac{\text{specific sand volume} * PE}{1000 * 365} = \text{absolute sand volume}$$

$$\frac{\text{specific grease volume} * PE}{1000 * 365} = \text{absolute grease volume}$$

spec. sand/grease vol.	volume after water separation	$\frac{1}{P * a}$
PE	Number of People	$P$
<i>absolute amount</i>	<i>amount after water separation</i>	$\frac{m^3}{d}$

The extractable mixture volume can be calculated through the sand and grease concentration.

$$Q_{S/F} = \frac{\text{absolute amount}}{c_{S/F} * 10} \quad \left[ \frac{\text{m}^3}{\text{d}} \right]$$

$Q_s$	daily sand-water-mixture output	$\frac{\text{m}^3}{\text{d}}$
$c_s$	concentration of sand within the sand-water-mixture <i>5 % equals 50 kg sand per extracted m<sup>3</sup></i>	%

## 8 Data Bank

In the databank the machines required for the operation of the wastewater plant are specified with their technical data and reference costs. Altogether four different databanks for mixing devices, screw pumps, centrifugal pumps and blowers are available.

In the form **Aeration** the databanks for blower and mixing devices are available.

In the form **Return Sludge** the databanks for screw pumps, centrifugal pumps and air lift pump blowers are accessed.

In the form **Sludge Container** a databank for selecting mixing devices is connected.

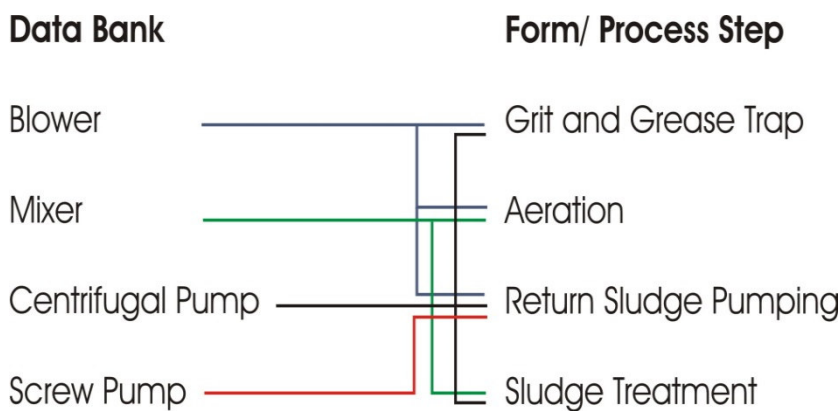

Clicking on **DATA BANK** in each of the above mentioned forms will open and give access to the databank.

When opening a databank a suitable machine is suggested selected according to specific criteria. The selection procedure for each databank is described below. Next to the databank window another window is placed displaying the relevant data for the selection of the according installation.

Hersteller	Baureihe	Fabrikat	Gegendruck (mbar)	Förderung (m³/h)	Nennleistung (kW)	Leistungsaufnahme (kW)	Strom (A)	Spannung (V)	Motorwirkungsgrad (%)	Cosφ	L
Aerzen	Delta Blower G5	GM 30 L	650	1400	37	26	0	0	93	0	B
Aerzen	Delta Blower G5	GM 30 L	650	1500	37	27,5	0	0	93	0	B
Aerzen	Delta Blower G5	GM 80 L	650	1800	55	44	0	0	94	0	B
Rietschle	DLT	6	700	5,7	0,3	0,3	0	0	68	0	B
Rietschle	DLT	10	700	8,3	0,45	0,45	0	0	72	0	B
Rietschle	DLT	25	700	22	1,1	1,1	0	0	77	0	B
Rietschle	DLT	40	700	37,8	1,85	1,85	0	0	80	0	B
Becker	KDT	3.60	700	47	2,2	1,6	0	0	81	0	B
Becker	KDT	3.60	700	48	2,2	1,7	0	0	81	0	B
Becker	KDT	3.80	700	62	3	2,4	0	0	83	0	B
Rietschle	DTA	80	700	66	3	2,4	0	0	83	0	B
Aerzen	Delta Blower G5	GM 3 S	700	78	4	3,1	0	0	83	0	B
Aerzen	Delta Blower G5	GM 3 S	700	78	4	3,12	0	0	83	0	B
Becker	KDT	3.100	700	90,5	4	3,2	0	0	83	0	B
Aerzen	Delta Blower G5	GM 3 S	700	108	5,5	3,79	0	0	82	0	B
Aerzen	Delta Blower G5	GM 4 S	700	114,6	5,5	4,1	0	0	82	0	B
Aerzen	Delta Blower G5	GM 4 S	700	114,6	5,5	4,12	0	0	82	0	B
Becker	KDT	3.140	700	127	5,5	4,4	0	0	82	0	B
Aerzen	Delta Blower G5	GM 3 S	700	133,8	5,5	4,32	0	0	82	0	B
Aerzen	Delta Blower G5	GM 3 S	700	133,8	5,5	4,36	0	0	82	0	B
Aerzen	Delta Blower G5	GM 3 S	700	142,2	5,5	4,56	0	0	82	0	B
Aerzen	Delta Blower G5	GM 4 S	700	157,2	7,5	5,03	0	0	83	0	B
Aerzen	Delta Blower G5	GM 3 S	700	159	5,5	4,9	0	0	82	0	B
Aerzen	Delta Blower G5	GM 7 L	700	174,6	7,5	6,11	0	0	83	0	B
Aerzen	Delta Blower G5	GM 3 S	700	186	7,5	5,56	0	0	83	0	B

Fig. 126: Databank for Blowers

The recommended unit may be accepted or another unit may be chosen from the available selection.

If you want to select another record from the database, simply go to this record with the mouse and select it by double-clicking or by pressing the Apply key.

The refresh button always takes you to the automatically selected aggregate.

If there is no suitable conveyor unit in the database, you have the option of adding to the data set. To do this, select the first icon for a new data set in the icon bar.

An empty mask will appear for entering new data. Enter the key values of the chosen new installation into the according input fields.

Click on **Save Data** and to enter further choices select the appearing **Further Data** by clicking on **Yes**.

Again an empty mask appears to enter another set of data.

Gebläse-Datenbank - Hinzufügen	
Gebläse-Datenbank	0
Hersteller	
Fabrikat	
Baureihe	
Gegendruck (mbar)	0
Förderung (m³/h)	0.00
Nennleistung (kW)	0.0
Leistungsaufnahme (kW)	0.0
Strom (A)	0.00
Spannung (V)	0.0
CosJ	0.000
Motorwirkungsgrad (%)	0.0
Speichern Abbrechen	

Fig. 127: New Set

To leave this form by saving the last data set click on save data. The question **Further Data** appears. Click on **No**. You can also leave the form by **Cancel**. However in this case the last entered data are not saved.

Now the databank is automatically updated and the entered data sets are available for all future computations.

## 8.1 Pumps

Left to the databank window the minimum requirements for the selection of the corresponding pump are displayed. Here the transport capacity results from the required total transport volume divided by the number of operating pumps.



Fig. 128: Minimum Required Values

AQUA DESIGNER will suggest an installation when the data bank is accessed during the dimensioning. Primarily the program will take the transportation height into account and secondarily the transport volume.

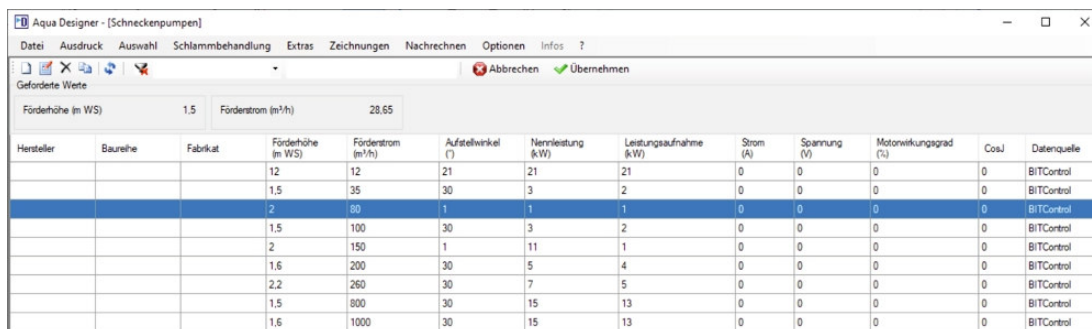

Fig. 129: Databank Screw Pump

The transportation height is the manometric transportation height. The Capacity is the maximum transport volume. It should be larger or equal to the previous displayed transport volume.

The nominal motor power of the engine corresponds with the specification on the engine type plate. The power consumption is the power requirement at the operation point.

The given type of pump enables you to find pump characteristics in a pump catalog.



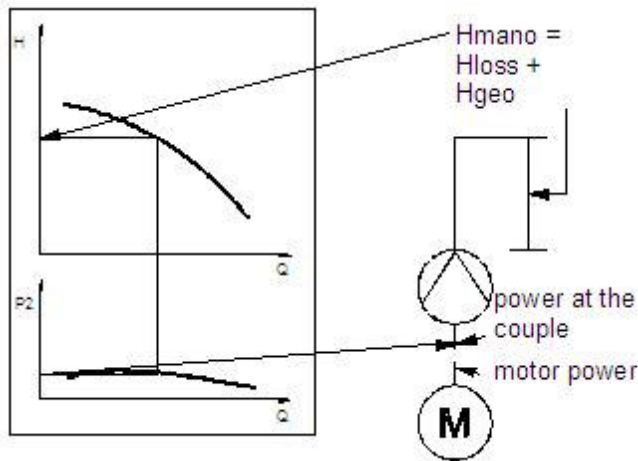

Fig. 130: Pump Characteristics and Capacity

## 8.2 Mixer

For the sludge container and the activated sludge tank mixing devices are selected. The required dimensioning data for selecting a mixing device or mixing devices respectively are displayed when accessing a databank window during the dimensioning process.

AQUA DESIGNER will suggest a unit that is selected according to the nominal capacity of the mixer engine. The mixer with the next in order nominal capacity is selected depending on the required energy input.

Aqua Designer - [Rührwerke]											
Datei Ausdruck Auswahl Schlammbehandlung Extras Zeichnungen Nachrechnen Optionen Infos ?											
Geforderte Werte											
Erforderlicher Energieertrag (kW) 0.5											
Hersteller	Baureihe	Fabrikat	Rührwerksdurchmesser (mm)	Nennleistung (kW)	Leistungsaufnahme (kW)	Strom (A)	Spannung (V)	Motorwirkungsgrad (%)	Cosφ	Datenquelle	
Xylem	Flygt Low speed	4351	175	0.8	0	0	0	0	0	BITControl	
Xylem	Flygt Low speed	4351	200	0.8	0	0	0	0	0	BITControl	
Xylem	Flygt Low speed	4351	175	0.9	0	0	0	0	0	BITControl	
Xylem	Flygt Low speed	4351	200	0.9	0	0	0	0	0	BITControl	
Xylem	Flygt Low speed	4410	2200	0.9	0	0	0	0	0	BITControl	
Xylem	Flygt Low speed	4351	175	1	0	0	0	0	0	BITControl	
Xylem	Flygt Low speed	4351	200	1	0	0	0	0	0	BITControl	
EMU	TR	225	2500	1.1	0	0	0	0	0	BITControl	
EMU	TR	325	2500	1.1	0	0	0	0	0	BITControl	
Xylem	Flygt Low speed	4351	175	1.2	0	0	0	0	0	BITControl	
Xylem	Flygt Low speed	4351	200	1.2	0	0	0	0	0	BITControl	
Xylem	Flygt Compact	4630	370	1.5	0	0	0	0	0	BITControl	
EMU	TR	60-2	600	1.75	0	0	0	0	0	BITControl	
EMU	TR	215	1500	1.75	0	0	0	0	0	BITControl	
EMU	TR	315	1500	1.75	0	0	0	0	0	BITControl	
EMU	TR	320	2000	1.75	0	0	0	0	0	BITControl	

Fig. 131: Databank Mixer

The recommended mixer may be accepted or another mixer may be chosen from the available selection.

The required energy input from the dimensioning is accepted for the power consumption. The investment costs are evaluated with this value.

## Activated Sludge Tank

A specific energy input is suggested or selected by the user in the window **Mixing Device** of the **Aeration** form. The databank suggests an adequate mixing device for the chosen specific energy input. Choosing a smaller mixing device than necessary for the chosen specific energy input the required quantity of mixers is calculated automatically.

### Example:

The activated sludge tank volume is 1000 m<sup>3</sup> and the specific energy input 3 W/m<sup>3</sup>.

AQUA DESIGNER suggests a mixer with minimum nominal capacity of 3 kW after accessing the databank. Now choose a mixer with 1,3 kW nominal capacity.

You will require at least three of the selected mixers to secure the required energy input.

$$3 * 1,3 \text{ kW} = 3,9 \text{ kW} > 3,0 \text{ kW}$$

For the following computation three mixers with each 1,3 kW are selected.

## Sludge Container

In the form **Sludge Container** a specific energy input is preselected or chosen by the user as well. The databank selects a mixing device with a nominal capacity meeting the minimum requirements for the energy input.

The user may select a smaller mixing device.

In contrast to the selection process in the form **Aeration** however, the number of mixers is not increased.

The dimensioning will still take only one unit into account selecting a mixer with a nominal capacity lower than the chosen energy input.

You may add data or installation choices respectively to the databank by clicking on **New** when no suitable mixing device is available from the databank. An empty mask will appear for entering new data.

In the left window the required data from the computation are displayed.

The nominal capacity is the nominal capacity of the engine and is in accordance with the motor-type plate.

**Technical Informations:**

Usually slow rotating mixers are used in the biology. The diameter of the mixer is up to 2500 mm in these units with slow revolving propeller.

## 8.3 Blower

Blower are required for the aeration of the activated sludge tank and the return sludge transport.

In the dimensions considered here mainly rotary piston blower are used for the aeration. Compressors may be installed in small wastewater plants.

Predominantly compressors are used for the return sludge transport. This method of transport is particularly suitable for small plants.

### Aeration

The quantity of blowers is entered in the **Aeration** form. The required total hourly air volume is divided by the number of blowers.

Clicking on **Databank** the databank opens for the selection of blowers for the activated sludge tank aeration.

In the **Value** window the blower counter pressure and the required hourly air volume per blower is shown.

The counter pressure consists of the immersion depth and the aeration system losses.

The immersion depth is the water depth minus the installation level of the aerators. The installation level for the aerators is set as 30 cm above the tank base and a constructiv empirical value. The losses of the aeration system -pipeline losses and pressure losses of the aerator- are added with 150 mbar to the immersion depth.

**Example:**

The water depth was selected as 4,8 m.

The immersion depth is 4,5 m. This results in a counter pressure of 450 mbar.

The pressure loss in the pipeline and aeration system is 150 mbar.

Thus the counter pressure for the dimensioning of the blower is 600 mbar.

### Return Sludge Transport

Blower are available from the corresponding databank when choosing the option **Air Lift Pump** in the **Return Sludge** form.

Predominantly compressors are available for this application as air lift pumps are particularly suitable for small wastewater plants.

Compressors are economic for small air volumes.

Enter the number of blowers in the **Air Lift Pump** window. The required air volume is divided by the entered number of blowers.

Here the counter pressure results directly from the secondary sedimentation tank water depth ( $h_e = WT$ ).

Primarily AQUA DESIGNER selects from the databank based on the counter pressure.

Hersteller	Baureihe	Fabrikat	Gegendruck (mbar)	Förderung (m³/h)	Nennleistung (kW)	Leistungsaufnahme (kW)	Strom (A)	Spannung (V)	Motorwirkungsgrad (%)	Cosφ
Aerzen	Delta Blower G5	GM 30 L	650	1400	37	26	0	0	93	0
Aerzen	Delta Blower G5	GM 30 L	650	1500	37	27,5	0	0	93	0
Aerzen	Delta Blower G5	GM 80 L	650	1800	55	44	0	0	94	0
Rietschle	DLT	6	700	5,7	0,3	0,3	0	0	68	0
Rietschle	DLT	10	700	8,3	0,45	0,45	0	0	72	0
Rietschle	DLT	25	700	22	1,1	1,1	0	0	77	0
Rietschle	DLT	40	700	37,8	1,85	1,85	0	0	80	0
Becker	KDT	3,60	700	47	2,2	1,6	0	0	81	0
Becker	KDT	3,60	700	48	2,2	1,7	0	0	81	0
Becker	KDT	3,80	700	62	3	2,4	0	0	83	0
Rietschle	DTA	80	700	66	3	2,4	0	0	83	0
Aerzen	Delta Blower G5	GM 3 S	700	78	4	3,1	0	0	83	0
Aerzen	Delta Blower G5	GM 3 S	700	78	4	3,12	0	0	83	0
Becker	KDT	3,100	700	90,5	4	3,2	0	0	83	0
Aerzen	Delta Blower G5	GM 3 S	700	108	5,5	3,79	0	0	82	0
Aerzen	Delta Blower G5	GM 4 S	700	114,6	5,5	4,1	0	0	82	0
Aerzen	Delta Blower G5	GM 4 S	700	114,6	5,5	4,12	0	0	82	0
Becker	KDT	3,140	700	127	5,5	4,4	0	0	82	0
Aerzen	Delta Blower G5	GM 3 S	700	133,8	5,5	4,32	0	0	82	0
Aerzen	Delta Blower G5	GM 3 S	700	133,8	5,5	4,36	0	0	82	0
Aerzen	Delta Blower G5	GM 3 S	700	142,2	5,5	4,56	0	0	82	0
Aerzen	Delta Blower G5	GM 4 S	700	157,2	7,5	5,03	0	0	83	0
Aerzen	Delta Blower G5	GM 3 S	700	159	5,5	4,9	0	0	82	0
Aerzen	Delta Blower G5	GM 7 L	700	174,6	7,5	6,11	0	0	83	0
Aerzen	Delta Blower G5	GM 3 S	700	186	7,5	5,56	0	0	83	0

Fig. 132: Selection of Blowers

The introduction level for the compressed air should preferably be as deep as possible for the most effective result. The pipeline losses are small.

#### Example:

Having selected a tank with a water depth of 6,5 m in the Secondary Sedimentation Tank form a counter pressure of 6,5 mWS is displayed in the databank **Required Value** window. The databank selects a blower based on this value.

The selection is primarily based on the counter pressure and secondarily on the transport volume.

The power consumption is the power requirement at the operation point.

The given type of pump enables you to find pump characteristics in a pump catalog.

BITControl	AQUA DESIGNER 9.2 - Manual	Seite: <b>219</b> von 314
	9 Project Data Bank	Version: <b>92-00</b>

## 9 Project Data Bank

Under File> Database> Add New Project you can save the results of your calculation in an Access database. In the database, detailed results with all interesting intermediate values are stored.

The data is structured according to the project name. So give your project a meaningful project name in the form Load. The file name is not used for the data storage.

If a project already exists with the project name you have selected, you will be asked to replace this project. If you select YES, the existing project will be overwritten. If you want to keep the old project, select NO and give the project a different project name in the form Load.

In future, tools for evaluating various projects will be added to the Access database. Then you will have the opportunity to compare and evaluate projects based on graphs and reports.

## 10 Menu Report

**Menu > Report** contains a complete documentation of the selected processes and chosen concepts.

It includes the description, the documentation of the computations, machine- and measuring lists and a summary of the operating and investment costs.

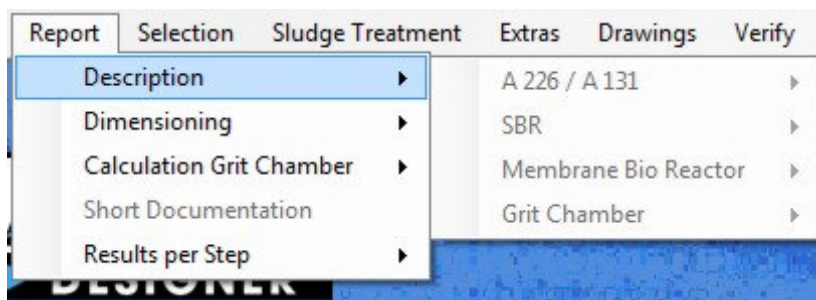

Fig. 133: Menu Report

The design layout is prepared in a way that it is presentable as documentation or validation without requiring further editorial work.

Please note that the text may be printed in English as well as German using the menu bar language option.

### 10.1 Operation

#### Keys and Scroll Bars

Different keys are available to you in the design layout.

With the >> and << keys you can go forward and backward in the document.

A scroll bar is available for longer texts. Clicking on the scroll bar to the right of the screen will move the text vertically up or down.

Return to the **Main Window** clicking on **OK**.

#### Printing

You may instantly print individual design components by clicking on **Print**. In AQUA DESIGNER only the complete text will be printed for the Description and the calculation of operating and investment costs.

Individual parts may be printed from the technical wastewater plant dimensioning. Choose **Print** from the menu bar located on the right. A window appears asking for **Print All** or **Print Current Page**. Choosing **Print Current Page** will print the current page on the screen. The complete technical wastewater computation will be printed with **Print All**.

The printer configuration can not be changed in the AQUA DESIGNER program.

The printer settings should be on **DIN A4, Portrait Orientation** before starting to print. You can set up the printer configuration in another WINDOWS program e.x. Word or Excel or in the Print Manager.

## 10.2 Description

The selected wastewater plant concept is described in detail in the Description. The textblocks are assembled according to the **Component Selection** for the Pretreatment Step, Outflow and the operation building. These construction groups were not covered in the preceding computation process. They are to be selected separately. You will find the details in the chapter on 'Extras'.

The description of the biological step is automatically assembled following the according computation. The according documentation will be presented in the description depending on the selection of denitrification and phosphorus removal.

The *Description* is accessible with **Report > Description**.

A title page for the description appears. The complete description may be printed on this page.

Clicking on **Title Page** will print a cover page for the complete design layout with description, technical wastewater plant computations and operation and investment cost evaluation.

## 10.3 Dimensioning

The dimensioning is documented in detail in the calculation validation or the technical wastewater plant computation respectively. The calculation steps are presented in detail to enable confirmation and validation.

### Sections of the Technical Plant Dimensioning:

#### Basic Data

- Wastewater Inflow
- Loads
- Selected Concept

#### Biological Step

- Activated Sludge Tank
- Construction

- Oxygen Demand (Denitrification optional)
- Technical Equipment
- Heat Removal in the blower room
- Phosphorus Removal (optional)
- Secondary Sedimentation Tank
- Construction
- Technical Equipment
- Clear Water Outlet (*Effluent Outlet*)
- (*Scaled*) Drawing

### Return Sludge Pump Station

- Excess Sludge Pump Station
- Sludge Treatment Construction
- Technical Equipment

The technical wastewater dimensioning documents the conducted computation in the AQUA DESIGNER program and thus, refers only to the biological step.

The technical wastewater dimensioning is accessible with **Documentation > Dimensioning**.

The title page for the technical wastewater dimensioning appears.

### Scaled Drawing

You can go directly to the scaled drawing with the **Drawing** key facilitating the review of the computation.

**The drawing is a scaled drawing.  
It is automatically and stepwise  
adapted  
to the page setting of the print**

The drawings consist of a top view and section with construction measurements.

The selected construction is presented in the drawing corresponding with the chosen construction type e.x. separate tanks, package plants, compact plants.

The display on the screen depends on the chosen screen view. The print automatically adapts to the chosen printer parameter.

The scale resulting from the adaption is shown.

Clicking **OK** on any page will bring you back to the **Main Window**.

## 10.4 Calculation of the Grit Chamber

If the grit and grease chamber has been selected in **Selection**, the documentation



BITControl	AQUA DESIGNER 9.2 - Manual	Seite: <b>223</b> von 314
	10 Menu Report	Version: <b>92-00</b>

can be printed here.

## 10.5 Short Print

A conclusion of the way of design is collected and provided for printing.

## 10.6 Individual Results

The calculations for activated chamber and clarifier can be printed individually.

## 10.7 Machine List – Excel Export

Based on the calculation and the selection in **Extras – Components**, a list of machines and measuring equipment is generated and can be exported to Excel. The machine list contains a standard set of machines, as it is usually required for a sewage treatment plant according to the selected procedure.

For the machines selected from databases, all data is also concluded in the machine list. These are the motor data, flow rates, machine types and makes.

A plant identification system is also automatically generated in the list. The identification numbers are also the link to the flow diagram.

## 10.8 Machine List – XML Export

A XML file can be generated as interface to other software products. For example the list can be imported by “ISO by Zahnen” and will be used as basis for further engineering steps.

## 10.9 Supplementary Calculations

Additional calculations are conducted on the basis of the dimensioning data and documented in the technical wastewater dimensioning.

### Industrial and Trade Components

Two different values are indicated for the concentrations of wastewater components in the basic data.

Initially the data are shown as entered in the form **Basic Data** viewing each single part of inflow.

The concentrations of the municipal, trade and industrial wastewater components are related to the Dry Weather Flow in the following table for **Wastewater Inflow**.

Thus, the fraction of each component in relation to the total inflow is shown. The single concentrations in the table add to the total concentration of the corresponding components.

### Air Exchange in the Blower Room

Care has to be taken for the room temperature not to rise too high when the blowers are installed within a building. The heat emission from the engines must be conducted off the room.

Part of the heat is transmitted off the room by the blowers that are constantly drawing in air from outside and transmit warm air into the activated chamber.

If this process of heat removal is incomplete an additional Ventilator must be installed that removes any remaining heat with an adequate airflow.

The radiated heat from the engines results from the (thermal) efficiency. A total of 15 % of the nominal capacity of the engine is set as heat loss.

The required air volume for heat removal is dependent from the specific heat capacity of the air and the density.

The required flow for the heat removal results to:

$$Q_L = \frac{n_G \cdot P_n \cdot \varepsilon \cdot 3600}{c_p \cdot \rho_L \cdot dT} \quad \left[ \frac{m^3}{h} \right]$$

$n_G$	Blower Quantity	
$P_n$	Nominal Capacity	[kW]
$\varepsilon$	Heat Loss Share of the Motor Capacity	
$c_p$	Specific Heat Capacity	[kJ/(kg * K)]
$\rho_L$	Density of Air	[kg/l]
$dT$	Tolerated Temperature Increase in the Blower Room	[K]

The physical characteristics of the air -specific heat capacity  $c_p$  and density  $\rho_L$  - are taken from the VDI-Wärmeatlas /16/.

Physical Characteristics at 25°C and 1 bar:

$$c_p = 1,007 \text{ [kJ/(kg*K)]}$$

$$\rho_L = 1,168 \text{ [kg/m}^3\text{]}$$

It is possible to install the blowers outside a building. In this case no additional heat removal is necessary.

For small population equivalents the blowers are often sufficient to remove the produced air with the air flow for the biology. No ventilation is required in this case.

It is not permitted to directly use the warm air from the blower room for the temperation of the screen room. This is prohibited because the screen

BITControl	AQUA DESIGNER 9.2 - Manual	Seite: <b>225</b> von 314
	10 Menu Report	Version: <b>92-00</b>

room is defined as hazardous area.

### **Pipelines**

The siphon pipe from the activated sludge tank into the secondary sedimentation tank is designed for a maximum flow velocity of 0,5 m/s.

The outlet pipe is designed for a maximum flow velocity of 1,0 m/s.

## 11 Menu Sludge Treatment

The concept of sludge treatment depends on the kind of process of the water line.

If simultaneous aerobic sludge stabilization is chosen, its possible to dimension one or more sludge storage tanks.

If the water line is designed for separate sludge stabilization, tools for anaerobic sludge stabilization are available.

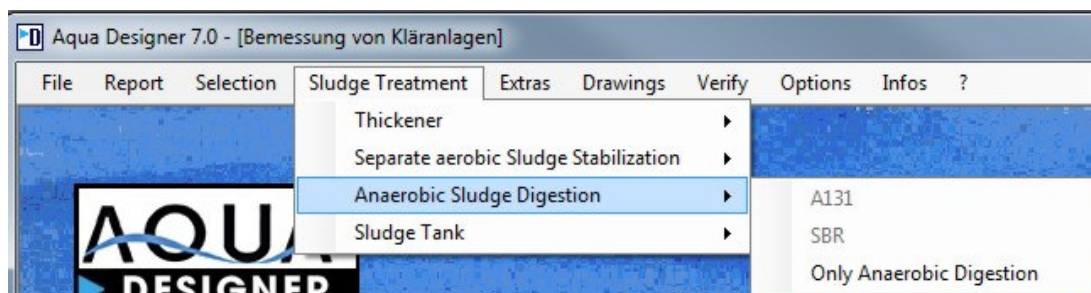

Fig. 134: Menu > Sludge Treatment

### 11.1 Thickener

Before treating the sludge, it should be thickened in a static thickener to 20 – 40 kg/m<sup>3</sup>.

The formular for the design of a thickener is available via **Sludge Treatment > Thickener**.

The thickener is simply designet for the retention time, oriented on the recommendations of Imhoff /44/.

You can edit the concentration after thickening at **Options > General Constants > Sludge Treatment**.

Also herefor you find recommendations at Imhoff: "Handbuch der Stadtentwässerung"/44/ and also in the ATV-"Handbuch Klärschlamm".

Kind of Sludge	Thickening Time	Possive DS-Concentrations
Raw Sludge	1 d	8,0 %
Activated Sludge		1 – 5 %
Sludge from Aerobic Thermophil Sludge Treatment (ATS)		3 – 5 %
Mixed Sludge		3 – 7 %

The common device for thickening is the rabble rake. If you choose the rabble rake, its energy demand will be considered in the operating costs.

The anaerobic digester has to be feeded from the thickener. Therefor here you can select a progressive cavity pump. The energy for feeding will then also be

considered in the operating costs.

Thickener

Mixer  Sludge Rake

progressing cavity pump

Retention Time  d

Volume 653,47 m<sup>3</sup>

Chosen Diameter  m

Height 33,28 m

Fig. 135: Collected sludge and disposal costs with individual groups

The supernatant will also be considered in the total balances and is taken in account for the internal flows.

## 11.2 Sludge Tank

For sludge treatment the storage in one or several sludge containers with gravitational thickening is planned.

Clicking on **Menu > Sludge Treatment > Sludge Tank** the form for dimensioning the sludge container opens.

sludge tank

Mixer

Centrifugal Pump

Sludge storage time  d

Number of Tanks

Calculate

Minimum Volume of each Tank 886,99 m<sup>3</sup>

Chosen Diameter  m

Calculate

Height 11,29 m

Fig. 136: Form Sludge Container

### Sludge Detention Period

A sludge detention period of 90 d is suggested. This value may be altered in the corresponding input field by the user.

The sludge detention period depends on the wastewater plant size, the method of disposal and any further sludge treatment. A sludge detention period of 180 d is often demanded for small wastewater plants. A minimum period of 3 months - the nonvegetation time- has to be maintained for agricultural disposal. This corresponds with the above value.

The sludge detention period may be reduced depending on the operational requirements if a sludge dewatering process is planned. A common value for the sludge detention period is 20 d. This applies for a mobile mechanical sludge dewatering as well.

### Thickening

Through sole gravitational thickening of aerobically stabilized sludge a maximum solids concentration of 5 % or 50 kg/m<sup>3</sup> respectively is achieved.

Using preliminary dewatering processes (like centrifuges or drum sieves) the sludge is thickened to a value of about 8 %.

Adding flocculants increases the solids concentration.

### Container Quantity

The construction of several containers is recommended for large wastewater plants. Operational advantages include the possibility of alternate loading of the containers and consequently the increase of the detention period for gravitational thickening.

Clicking on the first field for **Calculate** the required volume for each container is shown. Choosing two containers the displayed volume represents half of the required total volume.

A diameter is preselected. Clicking on the second field for **Calculate** the corresponding water depth appears. Selecting a different diameter in the input field **Diameter, selected** the geometry of the sludge container may be altered.

### Mixing Device

The contents of the sludge container are mixed in intervals to dissolve water accumulations in the sludge. A specific energy of 30 W/m<sup>3</sup> applied by the mixing device is suggested for the above solids concentration and sole thickening of about 5 %.

This value is preselected in the window **Mixing Device**. It may be altered by the user entering another value in the input field **Spec. energy input**.

Choosing a lower specific energy for the mixing device is recommended for lower thickening rates selected by the user.

Clicking on **Databank** the databank for the mixing devices appears. The best matching mixing device from the databank is suggested.

See the chapter on databanks for details on databank function and operation..

Return to the **Main Window** with **OK**.

## 11.3 Anaerobic Sludge Digestion

### 11.3.1 General

Before calculating the sludge treatment, the water line has to be completed.

The instructions leaflet ATV-VDWK-M 368 defines the economical limit for the anaerobic stabilization of sludge at 10.000 – 50.000 population values [/47/](#). Due to the changed funding situation through the subsidies for regenerative energy and constantly increasing energy costs it is necessary to check this evaluation. Due to the tendencies at the energy market the anaerobic stabilization of sludge is sure to be economically efficient for ever-decreasing constructions. Withal the condition is, that the utilisation of gas occurs through a cogeneration unit (CHP) . It is really necessary to check this, resp. include it in planning, while choosing the anaerobic stabilization of sludge.

The treatment methods of the anaerobic stabilization of sludge are multifaceted. It involves as well the method of dewatering in single dewatering stages, as the rotting process and finally gas utilisation itself.

AQUA DESIGNER provides the basic scheme. With this basic scheme you can measure the single positions and receive sufficient exact information about the volume of sludge and energy questions for the draft stage. The dewatering aims for preliminary dewatering; in most cases as static thickening or dewatering of the full-rotten sludge, usually through mechanical sludge dewatering, can be determined in the form **General constants**. In addition see the section **Dry matter content**

somewhat further below.

Particularly the integration of the sludge treatment in the entire calculation allows you the energetic comparison of the simultaneous aerobic stabilization of sludge and the anaerobic sludge rotting process. In such a way a very important construction module for the evaluation of the entire economic efficiency is provided.

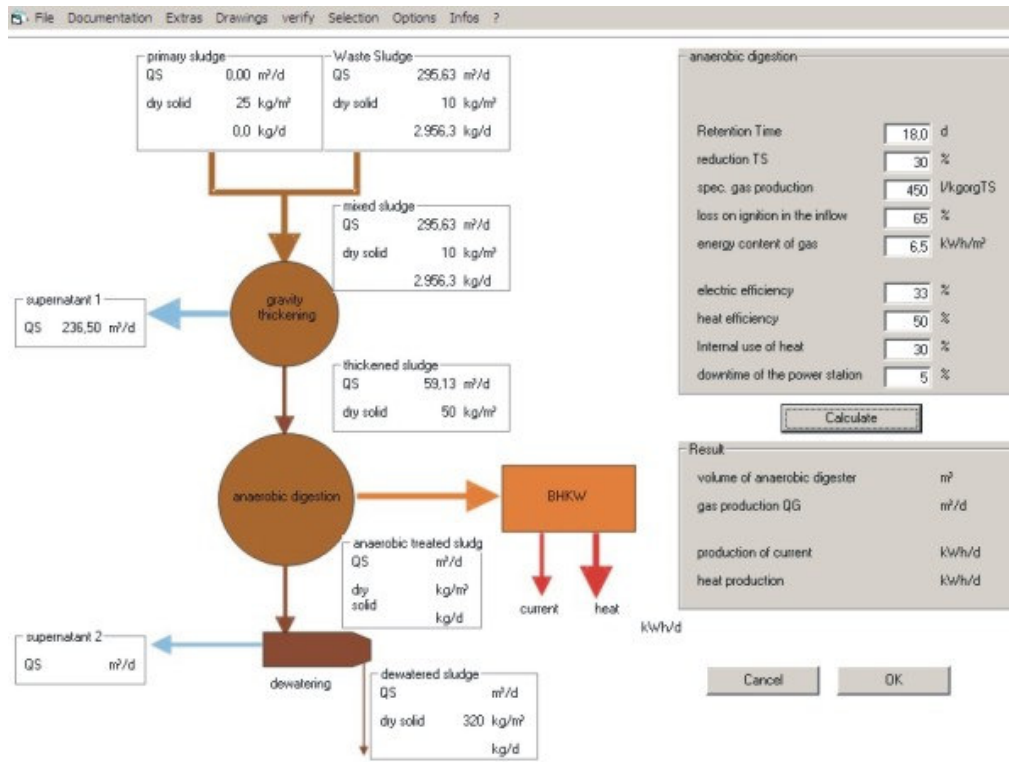

Fig. 137: Form Anaerobic Sludge Digestion

### 11.3.2 Handling

To design the rotting process of the sludge, select in menu **Extras > Sludge treatment > Anaerobic sludge digestion** for the actually applied method (A 131 or SBR).

In order to interpret the rotting process based on the measurement of the biological level, you must first of all measure completely the water way, i.e.: clearing basin in the down-stream stage, vitalizing basin, aeration and return sludge delivery. The measured way in the fill-in form must be completely selected in green. Than the calculation of the rotting stage, appropriate to the measurement of the waterway, is available for you.

### 11.3.3 Activated and Thickened Sludge

Two sludge flows are feede into the Sludge Treatment. The primary sludge is untreated and unstabilized. This compartment is very good digestible or fermentable. The surplus activated sludge is partly stabilized. It depends on the sludge age of the biological stage.



## Primary Sludge

The amount of primary sludge results out of the suspended solids in the inflow  $X_{TS,Z}$ , the efficiency of separation in the primary sedimentation and the dry solids concentration in the primary settling tank.

$$PS_d = \frac{DS * PE * d_{DS,PS}}{1000 * DS_{PS}} \left[ \frac{m^3}{d} \right]$$

PS	Primary Sludge Amount	$m^3/d$
DS	Suspended Solids Inflow	$g/(PE*d)$
PE	Population Equivalent	
$D_{DS,PS}$	Decrease of suspended solids	%
$DS_{VK}$	Thickening in the primary sedimentation	$kg/m^3$

## Surplus Activated Sludge

The surplus activated sludge will be calculated in the biological treatment part.

## Thickened Sludge

A simple design method for the thickener is contained.

Kind of Sludge	Thickening time	Dry solids concentrations
Pre sedimentation sludge	1 d	8,0 %
Activated sludge/waste sludge		1 – 5 %
Sludge out of ATS		3 – 5 %
Mixed sludge		3 – 7 %

Standard Values from Taschenbuch der Stadtentwässerung [/44/](#).

The tank is dimensioned, based on the retention time.

### 11.3.4 Anaerobic Digestion

Retention time of the anaerobic digester

$$tRt = \frac{Q_{sludge}}{V_{Digester}} = 20 \text{ [d]}$$

Tank volumes of more than 10.000 – 15.000  $m^3$  are not recommended.

Load	Hydraulic Retention Time ( $t_R$ ) d	Organic Dry Solids Volume Loading $\frac{kgoTS}{m^3 \cdot d}$

Smaller Plants < 50.000 PE	20	2,0
Middle Sized Plants 50.000 – 100.000 PE	15 – 20	2,0-3,5
Large Sized Plants > 100.000 E	15	3,5-5,0

Table 4.2-10 /49/. Standard Values for digester design (summary)

For above recommended standard values the following conditions should be complied /49/:

- Municipal, pre thickened sludge, without specific industrial influence
- Primary Sludge without inhibiting compartments
- Fermenter Temperature 35 – 37 °C
- Pre Heating of the sludge to fermenter temperature
- Mixing of the fermenter about 5 times per day and 20 operation hours per day
- Feed of the fermenter in multiple charges, minimum 3 charges per day
- With included rainwater treatment or chemical precipitation ann additional volume of 20 % is recommended.

Further to the retention time the organic volume loading should be verified. [/44/](#)

$$BRF = \frac{Q_{rawsludge} * \frac{DS_{rawsludge}}{100} \% * \frac{GV}{100} \%}{V_F} \quad \left[ \frac{kgOTR}{m^3 \cdot d} \right]$$

BRF = 2 – 3 kgorgTS/(m<sup>3</sup>xd)BRF = 2 – 3 kgorgTS/(m<sup>3</sup>xd)

BRF

GV

V<sub>F</sub>

Middle sized plants

Large sized plants

Organic volume loading

Volatile, loss on ignition

Volume Fermenter

kgorgTS/(m<sup>3</sup>xd)kgorgTS/(m<sup>3</sup>xd)kgOTR/(m<sup>3</sup>d)m<sup>3</sup>

## Mixing

The specific power density for mixing has to be 5 – 15 W/m<sup>3</sup>, depending on the dry solids concentration in the tank.

## Heating

To secure the process temperature of about 37 °C, the digester has to be provided with heat. This heat is usually produced out of the gas. An average value for the heat demand of the process will be 30 % of the produced heat.

## Gas Production

An intensive mixing is important for good gas production. Also static conditions of raw sludge feeding and temperature are very important.

Kind of operation of the biological stage		Organical Load	Expected biogas production
1.	Sludge age activated chamber (AC)tTS = 8 d (Nitrification in summer, partly denitrification)	Inflow activated stage 35 g BOD5/(PE x d) (large sized primary sed.)	Average: 20,7 l/(PE x d) Intervall: 16,5 – 25 l/(PE x d)
2.	Sludge age (AC) tTS = 15 d (Nitrification and Denitrification)	Inflow activated stage 35 gBOD5/(PE x d)	Average: 18,3 l/( PE x d) Intervall: 10,5 – 15,9 l/( PE x d)
3.	Sludge age (AC) tTS = 15 d	Inflow activated stage 48 gBBO5/(PE x d) (no primary sed.,rough desilting)	Average: 13,2 l/(Ewxd) Intervall: f10,5 – 15,9 l/( PE x d)
4.	Sludge age (AC)tTS = 15 d	Inflow activated stage 60 gBOD5/(PE x d) (without primary sed.)	Average: 7,8 l/( PE x d) Intervall: 6,2 – 9,4 l/( PE x d)
5.	Extended aeration min tTS = 25 d	Inflow activated stage 50 gBOD5/(PE x d) (without primary sed.)	Average: 4,4 l/( PE x d) Intervall: 3,5 – 5,3 l/( PE x d)

Table 5 [/46/](#): Dependence of the expected biogas production from the process of wastewater

Recommended values for gas production:

/44/ Imhoff, 450 l/kgO<sub>2</sub>MLSS

/47, DWA, 400 – 500 l/kgO<sub>2</sub>MLSS

The energy content of biogas with 60 -70 Vol% Methan is about 6,0 – 7,0 kWh/m<sup>3</sup>.

[/46/](#) /49/

## 11.4 Separate Aerobic Sludge Stabilization

The design is based on the leaflet DWA-M 368/47 / "Biological stabilization of sludge". There are two ways of aerobic stabilization in AQUA DESIGNER available.

These are the separate aerobic stabilization at normal temperature and the aerobic thermophilic sludge stabilization.

Handling

Separate aerobic sludge treatment is available through sludge treatment menu>

Separate aerobic stabilization. The menu is activated only when a waterway, A 226, A131, SBR or MBR is completely calculated.

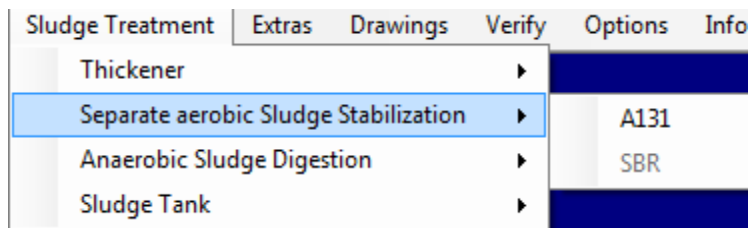

Fig. 138: Menu Separate aerobic Sludge Stabilization

## Primary and Excess Sludge

Two streams of sludge, the sludge treatment are supplied. The primary sludge from the primary settling stage is completely untreated and not stabilized. It has high organic contents and needs to be further stabilized.

The excess or secondary sludge is partially stabilized. The degree of stabilization depends on the sludge age, which is established in biology.

The primary sludge produced in the primary settling stage is determined from the suspended solids in the feed to the treatment plant XTS, Z, the separation and the achievable dry matter concentration in the primary settling stage. It is calculated using the following formula:

$$PS_d = \frac{TS * EW * d_{TS,VK}}{1000 * TS_{VK}} \quad \left[ \frac{m^3}{d} \right]$$

PS	primary sludge amount	m <sup>3</sup> /d
TS	MLSS to the plant	g/(E*d)
EW	population equivalent	
d <sub>TS,VK</sub>	degradation of solids in the primary sedimentation	%
TS <sub>VK</sub>	thickening in the primary sedimentation	kg/m <sup>3</sup>

The excess sludge is calculated in biology.

## Thickened Sludge

Thickening of primary and excess sludge can be selected now. The degree of thickening is set in the general constants, as this value is also used in other places. Change the thickening degree, by changing the value in the **menu – options - global constants** in the map sludge treatment.

The thickening can be selected for both primary as well as excess sludge. After thickening the two streams are combined.

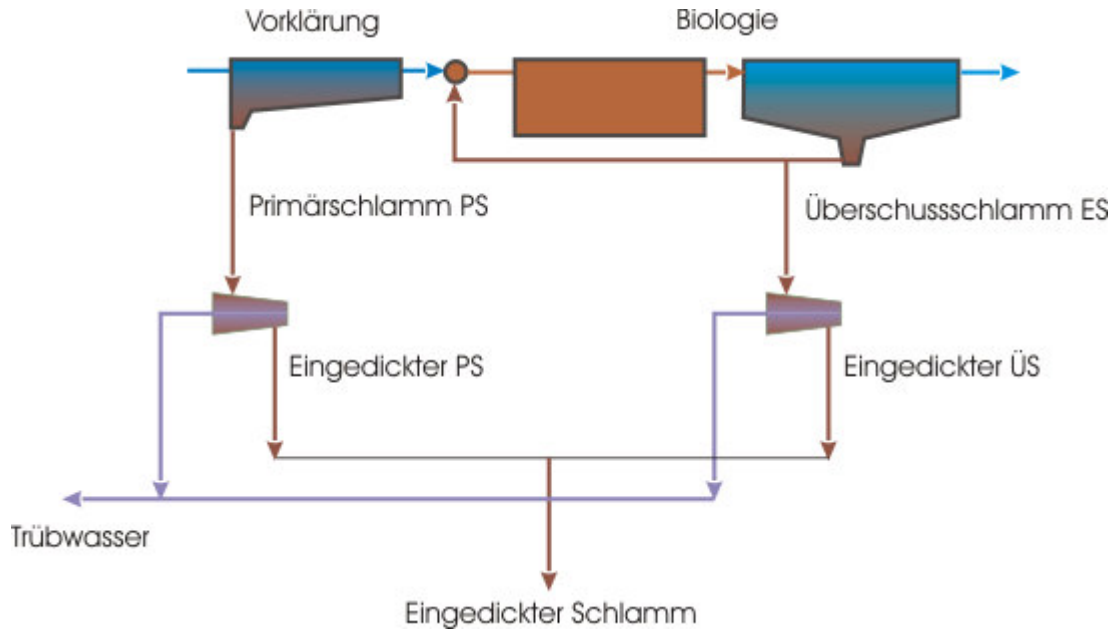

Fig. 139: Sludge thickening

It is recommended to treat the primary sludge static and the excess sludge mechanical / 47 /.

### 11.4.1 Material Balances for Thickening

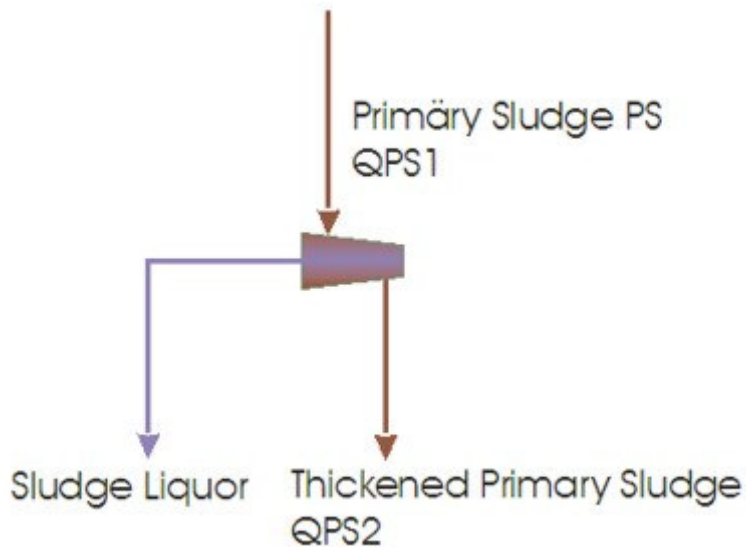

Fig. 140: Material Balances

#### Supernatant Amount

$$Q_{TW} = Q_{PS1} - Q_{PS2} \quad \text{m}^3/\text{d}$$

$$Q_{TW} = \frac{PS_d}{TS_{PS1}} - \frac{PS_d}{TS_{PS2}} \quad \frac{m^3}{d}$$

### Mixed Sludge and Concentrations

$$Q_{MS} = \frac{PS_d}{TS_{PS}} + \frac{\dot{U}S_d}{TS_{\dot{U}S}} \quad \frac{m^3}{d}$$

$$MS_d = PS_d + \dot{U}S_d \quad \text{kg/d}$$

$$TS_{MS} = \frac{MS_d}{Q_{MS}} \quad \frac{kg}{m^3}$$

PS <sub>d</sub>	Primary Sludge Amount per Day	kg/d
TS <sub>PS</sub>	Dry Solids Concentration PS	kg/m <sup>3</sup>
Q <sub>PS</sub>	Primary Sludge Volume per Day	m <sup>3</sup> /d
ÜS <sub>d</sub>	Excess Sludge Mass per Day	kg/d
TS <sub>ÜS</sub>	Dry Solids Concentration Excess Sludge	kg/m <sup>3</sup>
Q <sub>ÜS</sub>	Excess Sludge Volume per Day	m <sup>3</sup> /d
MS <sub>d</sub>	Mixed Sludge per Day	kg/d
TS <sub>MS</sub>	Dry Solids Concentration Mixed Sludge	kg/m <sup>3</sup>
Q <sub>MS</sub>	Mixed Sludge Volume per Day	m <sup>3</sup> /d
Q <sub>TW</sub>	Supernatant Volume per Day	m <sup>3</sup> /d

### Organic Part of Dry Solids Concentration

The organic dry matter concentration of the sludge is determined by Table 3, M 368 /47/

Primary Sludge

$$o_{TR}/TR = 0,67$$

Excess Sludge

t <sub>TS</sub> = 15 d, t <sub>R,PS</sub> = 1,0 h	o <sub>TR</sub> /TR = 0,7
t <sub>TS</sub> = 25 d, without PS	o <sub>TR</sub> /TR = 0,65

## 11.4.2 Separate aerobic Sludge Stabilization

The separate aerobic stabilization takes place in open uninsulated chambers. There is no appreciable increase in temperature due to the exothermic stabilization processes.

Key data for the design:

- Retention Time t<sub>R</sub> >= 20 d (Minimum Temperature T >= 10 °C)
- Operationally required solids content in stabilization basin 3 - 4% TR
- Required aeration capacity OC > = 2.2 kgO<sub>2</sub> / (m<sup>3</sup> \* d), for a VS destruction of 30-35%
- Required power density for aeration and mixing NR > = 50 W / m<sup>3</sup>

Air Demand

Luftbedarf

$$QL = \frac{OC * QMS}{\alpha * fO_2 * WT * 24} \quad \frac{m^3}{h}$$

OC	Oxygen Demand kgO <sub>2</sub> /(m <sup>3</sup> *d)
QMS	Mixed Sludge volume per day m <sup>3</sup> /d
α	Oxygen Input Factor, about 0.3 because of high dry solids content
fO <sub>2</sub>	Oxygen Input Capability of the Aerators gO <sub>2</sub> /(m <sup>3</sup> *m)
WT	Water Level m

### 11.4.3 Separate aerobic thermophilic stabilization

In insulated, covered containers, the medium is heated due to the exothermic decomposition processes up to 45 - 65 ° C. At the elevated temperature, the degradation processes run faster and there is simultaneously a decontamination.

Key Data for Design:

- retention time  $t > = 5$  d (minimum temperature T10 ° C)
- Operationally required solids content in stabilization basin from 3.5 to 6.5% TR
- Required aeration capacity  $OC > = 2.2$  kgO<sub>2</sub> / (m<sup>3</sup> \* d), for a VS destruction of 30-35%
- Required power density for aeration and mixing  $NR > = 80-180$  W / m<sup>3</sup>

Air Demand:

$$QL = \frac{1,2 * 3,367 * COD_{roh} * \alpha * VR}{\Delta O_2 * t_A * 24} \quad \frac{m^3}{h}$$

3,367	conversion factor m <sup>3</sup> L/kgO <sub>2</sub>
1,2	safety factor kgO <sub>2</sub> /kgCSBdeg
α	COD degradation degree
CSBroh	COD concentration in the raw sludge, ca. 1,6 kg/kg
t <sub>A</sub>	stabilization time d
VR	Reactor Volume m <sup>3</sup>

## 11.5 Sludge Balance

The retention time of sludge in the secondary sedimentation depends on the sludge removal process and the return sludge flow.

Mainly there are two kinds of sludge removal devices, sludge scraper and suction devices.

### Short-Circuit Sludge Flow

As the sludge removal flow rate  $Q_{SR}$  is oftgen smaller than the return sludge flow rate  $Q_{RS}$ , with sludge scrapers, a short-circuit sludge flow rate  $Q_{short}$  occurs between inlet and sludge removal point (hopper) and wirth suction facilities from the zone above the thickening zone.

The following applies:

$$Q_{Short} = Q_{RS} - Q_{SR} \quad (m^3/h)$$

Solid matter balance:

$$Q_{RS} * SS_{RS} = Q_{SR} * SS_{BS} + Q_{Short} * SS_{EAT} \quad (kg/h)$$

Short-circuit sludge flow  $Q_{Short}$ :

$$Q_{Short} = \frac{Q_{RS} * SS_{RS} - Q_{SR} * SS_{BS}}{SS_{EAT}} \quad \frac{m^3}{h}$$

$Q_{Short}$	short-circuit sludge flow in sedimentation hambers	$m^3 / h$
$Q_{RS}$	return sludge flow	$m^3 / h$
$Q_{SR}$	removal sludge flow rate	$m^3 / h$
$SS_{RS}$	suspended solids concentration in return sludge	$kg / m^3$
$SS_{BS}$	suspended solids concentration in the bottom sludge of secondary sedimentations	$kg / m^3$
$SS_{EAT}$	suspended solids concentration in the effluent of the biological reactor	$kg / m^3$

### Bottom Sludge and Return Sludge

Recommended thickening time:

- Activated chamber without nitrification: 1,5 - 2,0 ( $t_e$  in h)
- Activated chamber with nitrification: 1,0 - 1,5 ( $t_e$  in h)
- Activated chamber with denitrification: 2,0 - ( 2,5 ) ( $t_e$  in h)

The sludge removal device has to designed so, that the thickening time not will be exceeded.



Suspended solids concentration in bottom sludge:

$$TS_{BS} = \frac{1000}{ISV} * \sqrt[3]{tE} \quad \left[ \frac{kg}{m^3} \right]$$

The decrease of concentration because of short circuit sludge flow will be taken into account by the removal factor:

- scraper :  $SS_{RS}$  ca.  $0,7 * SS_{BS}$
- suction device:  $SS_{RS}$  ca.  $0,5 - 0,7 * SS_{BS}$

## 12 Menu Extras

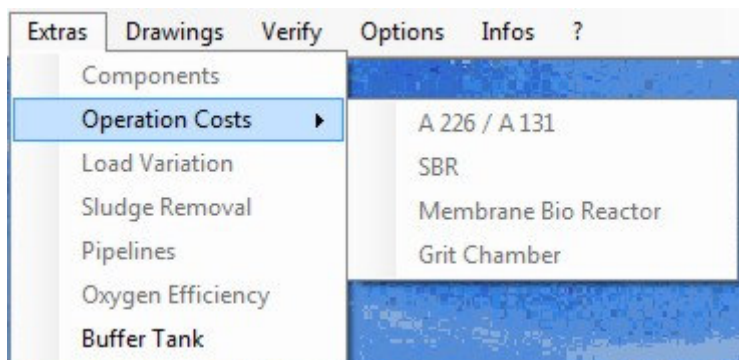

Fig. 141: Menu > Extras

### 12.1 Components

Additional components like inflow pumping station or screens can be selected in case to complete the documentation and the operational costs.

All parts which are calculated and designed with AQUA DESIGNER are not part of the components list.

As further result you get a machine and measuring list.

Based on the machine and measuring list a flow diagram is generated automatically.

In the sheet Extras – Components its possible, to create the construction of a wwtp. After selection text blocks, lists and operation cost is collected.

In a second map measuring equipment can be selected.

### 12.2 Operational Costs

Choose **description > operating costs** from the menu bar. The title window operating costs opens.

#### 12.2.1 Control Keys

Go back to the **Main Window** from any page with clicking on **OK**.

Return from the result display window to the basic data input fields for the operating cost calculation with the **>> key**.

Go directly to the window for entering the basic data for the operating cost calculation with the **<< key**. Changes in the calculation may be conducted fast with these keys.

Obtain a printout of the operating cost calculation with clicking on **Print**.

Choose **>>**.

The windows for entering the basic data of the operating costs opens.

The calculation of the operating costs incorporates the energy costs, sludge and residual material disposal costs and the personnel costs.

The basic data for the operating cost calculation are entered corresponding with the selection of components and the dimensioning.

Only the operating costs for the biological step in accordance with the selected calculation method are evaluated when no additional components were chosen.

The basic data for the evaluation of the operating costs is entered one after another into three different forms. These forms correspond with the categorization of the operating costs.

Efficiency and delivery head for pumps as well as population equivalents of further *Verbraucher* are entered in the form **Energy Consumption**.

The amount of accumulating sludge based on empirical values and the dimensioning is preselected for the form **Sludge Disposal and Disposal Costs**.

Labour requirements depending on the size of the wastewater plant and the design features are selected by the user in the **Personnel** form.

## 12.2.2 Energy Costs

Pump efficiency and delivery head is entered in the window **Energy Consumption**. The mean transport volumes are calculated based on the dimensioning.

Only the pumps for return sludge and excess sludge transport will be listed in the energy form when no additional components were selected.

Additional energy consuming devices are automatically shown when further construction groups were selected in the component selection.

### Pumping Stations

For the pumping stations:

- Inflow Pumping Station
- Intermediate Pumping Station
- Outflow Pumping Station

The delivery head must be reviewed individually and adapted manually as this value depends very much on the individual local conditions.

#### **Technical Informations:**

In the inflow pumping station the mechanical step particularly the screen should be served evenly. Screw pumps are particularly suited for this purpose.

Using centrifugal pumps in the inflow e.x. an even flow is enabled by frequency regulated engines.

It is to be noted that unclarified wastewater is transported. The free passage of the pumps should be at least 100 mm. The pressure pipe should at

least be selected as DN 100.

A plant efficiency of 65 % may be assumed as directive value for pumping station with centrifugal pumps.

Screw Pumps are particularly suitable to lift large water volumes over small height differences. Also they are suitable for the regular and even wastewater transport in the influent area. Using screw pumps for the return sludge transport is economical for large wastewater plants. Also the return sludge is transported with care, thus the activated sludge flocs stay intact and unbroken.

A plant efficiency of 75 % may be assumed for screw pumps, if the operating point recommends the choice of this kind of pump.

Air Lift Pumps are used for the return sludge transport. This method of transport goes with high operational costs. However, this is outweighed by favorable investment costs and a careful activated sludge transport in small plants.

The air lift pump efficiency is around 45 %.

### **Combined (Sewer) System**

The frequency of rain may be selected when the collector is constructed as combined (sewer) system. It determines the expected frequency of rain water occurrence. This value is taken into account in the evaluation of energy costs for pumping.

A yearly precipitation of 600 - 1000 ml can be accepted for Germany depending on the climate area. In case of a rainstorm only the initial high loaded peak is collected and reduced in volume flow before entering the wastewater plant. In the event of continuous rain the storage tank will only refill the discharged amount. Thus the ratio of the combined sewerage inflow to the total wastewater inflow depends on the length of period of a stormrain event.

The rain frequency depending on the number of rain days is to be entered for the region where the wastewater plant will be located.#

### **Wastewater Transport**

The required energy for the wastewater transport is calculated with the following equation, the law of energy conservation:

The energy consumption is shown for a whole year period:

$$E = \frac{24 \cdot 365 \cdot Q \cdot \rho \cdot g \cdot H}{e \cdot 3,6 \cdot 1000} \left[ \frac{\text{kWh}}{\text{a}} \right]$$

E	Energy Consumption	[kWh/a]
$\rho$	Density of the Water	[kg/m <sup>3</sup> ]

H	Manometric Pumping Head	[m]
g	Acceleration of Gravity	[m/s <sup>2</sup> ]
Q	Volume flow	[m <sup>3</sup> /h]
$\varepsilon$	Plant Efficiency	

The volume flow is calculated from the daily wastewater volume. An average hourly volume flow lower than the volume flow selected for the plant design results.

Only dry weather flow is present in the **separate sewerage system**. The hourly volume flow is composed of the domestic and extraneous wastewater inflow. In contrast to the dimensioning the dry weather flow is calculated for a 24 h period as well.

$$Q_{\text{average}} = \frac{Q_{\text{sd}}}{24} + \frac{Q_{\text{fd}}}{24} \quad \left[ \frac{\text{m}^3}{\text{h}} \right]$$

Qsd	daily domestic wastewater	[m <sup>3</sup> /d]
Qfd	daily extraneous wastewater	[m <sup>3</sup> /d]

The rainwater must be included into the calculation for the **combined sewerage system**. A frequency of stormrain events must be selected for evaluating average transport volumes.

The rain frequency  $n_R$  is entered in the window for **Energy Consumption** by the user.

The mean transport volume with consideration of the additional rain wastewater results as follows:

$$Q_{\text{average}} = \frac{Q_{\text{td}}}{24} + n_R * \left( Q_m - \frac{Q_{\text{td}}}{24} \right) \quad \left[ \frac{\text{m}^3}{\text{h}} \right]$$

Qtd	Daily Dry Weather Flow	[m <sup>3</sup> /d]
Qm	Hourly Rain Water Flow	[m <sup>3</sup> /h]

The individual plant efficiency depends on the selected installation. For each of the pumping stations centrifugal pumps, screw pumps and airlift pumps are offered depending on the selected method.

### Other Installations

The energy costs for the other installations is evaluated depending on the operating time and the nominal capacity.

### **Mechanical Clarification**

The size of the mechanical (preliminary) clarification correspond with the technical data of commonly used installations.

The operation period for the screen is preselected as 6 h/d based on an empirical value.

An operation period of 12 h/d is set when an aerated grit chamber is selected.

Air lift pumps transport the grit. The air lift pump is installed at the entrance of the grit chamber in the grit collecting channel. It resumes operation when the scraper reaches his start position. The operation period of the air lift pump is preselected as 2 h/d.

The operation period of the grit classifier corresponds with the air lift pump operation period that is 2 h/d.

The grease separator operates 2 h/d as well.

The operation of the grit chamber scraper is initiated through a time program (oder: controlled by a time switch). An operation period of 3 h/d is assu med.

Commonly Square Grit Chambers have only a short aeration period for the grit aeration and a grit transport mechanism. Here an air lift pump is assumed for the grit transport.

The power consumption is preselected according to experiences with well known installations.

### Biological Step

The rotary piston blower were selected from the databank during the dimensioning. There an aeration period was shown. The blowers were designed according to the air demand for the selected aeration period.

The blower output is generally slightly higher than the required air volume.

Furthermore the design oxygen load OB does not corresponds with the average oxygen load. In the design OB peak loads are included.

### Mean oxygen load based on the ATV A131

The mean oxygen load is calculated based on the A 131 /39/, however. the calculation does not include the peak loads or shock loads.

The shock factors  $f_c$  and  $f_N$  are selected as 1 in the equation for calculating the oxygen load.

Without shock factors OB, respectively  $OB_{\text{Schmutzwasser}}$  is

In *pure water*:

$$OB_{\text{purewater}} = \frac{C_s}{C_s - C_x} * (OU_c + OU_N) \left[ \frac{\text{kgO}_2}{\text{kgBOD}_5} \right]$$

In wastewater:

$$OB_{\text{wastewater}} = \frac{OB_{\text{purewater}}}{\alpha OB} \left[ \frac{\text{kgO}_2}{\text{kgBOD}_5} \right]$$

The mean yearly water temperature is selected as 15°C.

The oxygen saturation concentration for saturated water vapor air and standard pressure (101,325 kPa) is described as a temperature dependent value only /1/.

$$C_{s,\text{theor}} = \frac{2234,34}{(T+45,93)^{1,31403}} \left[ \frac{\text{gO}_2}{\text{m}^3} \right]$$

Thus the oxygen saturation concentration in 15°C is 10,09 mg/l.

For intermittant aeration:

$$\frac{C_s}{C_s - C_x} = \frac{10,09}{10,09 - 2,0} = 1,25$$

$C_s$  Oxygen Saturation Concentration *mg/l*

$C_x$  Operating Oxygen Concentration during the Aeration Period *mg/l*

$OU_N$  is selected depending on the chosen clarification process of nitrification or denitrification.  $OU_C$  as well as  $OU_N$  are known from the dimensioning.

$$OB_{\text{mittel}} = \frac{C_s}{C_s - C_x} * (OU_C + OU_N) \left[ \frac{\text{kgO}_2}{\text{kgBOD}_5} \right]$$

### Mean oxygen load based on the ATV A 226

A fixed mean OB is assumed for the evaluation of the blower operation period based on the A 226 /58/. The mean OB is:

$$OB_{\text{mittel}} = 2,5 \left[ \frac{\text{kgO}_2}{\text{kgBOD}_5} \right]$$

The daily air demand for the blower is calculated with the above evaluated mean OB. The average blower operation period results with the output capacity of the selected blower.

$$QL_{\text{Betrieb}} = \frac{OB_{\text{mittel}} * B_{d,\text{BOD}_5} * 1000}{fO_2 * hE} \left[ \frac{\text{m}^3}{\text{d}} \right]$$

$QL_{\text{Betrieb}}$  Daily Mean Air Demand *[m³/d]*

The true blower operation period is lower than the operation period based on the dimensioning because of the above described operating conditions.

Blower Operation Period:

$$tL_{\text{Operation}} = \frac{QL_{\text{operation}}}{QL_{\text{blower}} * n_{\text{blower}}} \left[ \frac{\text{h}}{\text{d}} \right]$$

$QL_{\text{Blower}}$  Selected Blower Output  $[m^3/h]$   
put

The blower power consumption is obtained from the databank.

AQUA DESIGNER allows the user to choose a blower with a lower than required capacity. In this case a notice to your attention appears in the Aeration form pointing out the selection.

In the calculation there is the possibility of a result of more than 24 h for the blower operation period if a much smaller blower is selected than suggested in the dimensioning process. In this event the operation period will automatically be fixed at 24 h/d. Only a maximum operation period of 24 h/d is possible for the blowers.

This design corresponds with the operation reality. The tank aeration is insufficient when blowers of insufficient size are selected even with their continuous operation.

### Operation Period of the Mixers

The mixers are usually operated continuously. They keep the activated sludge in suspension during the unaerated period and ensure a complete mixing of wastewater and activated sludge. The additional circulation improves the oxygen intake during the aerated phase.

The power consumption corresponds with the required energy supply in the dimensioning.

### Sludge Treatment

The sludge tank mixer is operated only for short periods to improve the settleability of the sludge. The power consumption corresponds with the required energy supply in the dimensioning and the operation period is 2 h.

The pump is designed for a default power of 1,5 kW and a daily operation period of 0,5 h. It is only required for the tank drainage.

The energy demand for pumping is listed at the pumping stations above.

The energy demand of the thickener and the mixing in the digester is based on experience and literature, like [/44/](#).

You are able to edit these values in the form.



## Total Energy Costs

The yearly energy consumption for each installation is assembled and summarized in a table.

Enter the prize for energy in \$/kWh into the **Energy Consumption** form.

The yearly energy costs result as a product from the yearly energy consumption and the specific energy prize.

Heat demand of the sludge treatment

The sludge treatment, especially the digestion itself needs a part of the produced heat for the digestion process. Therefore an average part of the produced heat is included in the energy balance. Its priced with the same tax as the produced heat.

### 12.2.3 Sludge Disposal

Different sludge types accumulate in the primary and biological treatment plant depending on the selected method of treatment.

In the preliminary treatment screenings and grit collect. Primary sludge from the primary sedimentation tank collects if a primary sedimentation tank was selected. Excess sludge from the biological step is collected and must be disposed of.

Amount of Sludge	
Grit	12,00 l/(P*a)
Grease	6,00 l/(P*a)
Waste Sludge	0,99 kg/kg
SS thickened	320 kg/m³

Removal Costs	
Grit	<input type="text" value="150,00"/> EURO/m³
Grease	<input type="text" value="150,00"/> EURO/m³
Waste Sludge	<input type="text" value="25,00"/> EURO/m³

Fig. 142: Collected Sludge and Disposal Costs with individual groups

In the above form not all building blocks of a wastewater plant are included. All

building blocks must have been previously selected in the component selection to obtain a complete assembly. The groups will automatically be displayed if they were already selected in the Description. In this form only the components resulting from the dimensioning will appear. This is the appearance when no additional components were chosen.

## Preliminary Treatment

### Screen Contents

AQUA DESIGNER considers the volume of collected screenings when a screen was selected for the preliminary treatment in the component selection.

From experience in the wastewater plant operation an unpressed screenings volume of about  $32 \text{ l}/(\text{E}^*a)$  collects. Usually the screening step is followed by a screenings press to reduce the screenings volume to  $16 \text{ l}/(\text{E}^*a)$ . The suggested value may be altered by the user.

#### Information:

The investment for a screenings press usually pays off fast as costs for disposal of screenings have become very expensive.

### Grit

The collecting grit is considered in the operation costs if a detritor, an aerated grit chamber, a grease trap or a compact installation is selected in the component selection.

The collected grit volume is classified and set as  $16 \text{ l}/(\text{E}^*a)$ . This value may be altered by the user.

Grit dewatering is not considered. In small wastewater plants container with bottom sieve screen and gate valves are used. In larger wastewater plants a grit classifier precedes the container.

### Grease

The collecting grease is considered in the operation costs when an aerated grit chamber and grease trap or a compact installation with grease trap is selected in the component selection.

Grease is usually separated in aerated grit chambers. The collecting grease is set as  $6 \text{ l}/(\text{E}^*a)$  on the basis of wastewater plant operation experience. This value may be altered by the user.

## Primary Sludge

The collecting primary sludge is considered in the calculation of the operating costs when a primary treatment is selected in the component selection.

The collecting primary sludge volume is set as about  $40 \text{ l}/(\text{E}^*a)$ .

## Disposal Costs for Primary Treatment

Costs for the disposal of the screenings, grease and grit disposal come from experiences with costs for landfill disposal. The costs vary largely for different regions and we recommend for the user to inquire on the local costs for disposal.

## Excess Sludge

The amount of collecting excess sludge results from the technical wastewater plant calculation.

The chemical sludge from the phosphate precipitation is included in the indicated amount of excess sludge.

The relevant sludge volume for the operation costs results after the thickening in the sludge container.

The disposal costs in the window **Sludge Disposal-Disposal Costs** applies to agricultural disposal. These costs vary in different regions as well and should be inquired locally.

## 12.2.4 Personnel Costs

The costs for personnel depend on the selected methods, the degree of automation and the wastewater plant size.

The report of the special ATV committee 2.12 for the operation of wastewater plants and personnel for the operation of wastewater plants (Arbeitsbericht des ATV-Fachausschusses 2.12 „Betrieb von Kläranlagen“ Personalbedarf für den Betrieb von Kläranlagen) includes recommendations for evaluating personnel requirements.

The report indicates the personnel requirements for wastewater plants serving population equivalents between 2000 and 250.000.

These costs should be evaluated with particular care as costs for personnel particularly in small wastewater plants may be of significant economic influence for a selected design.

The daily working period must be calculated from the working hours per week if the plant is not staffed daily.

E.x. a daily working period of 0,8 h/d results if the wastewater plant is staffed for half a day per week or 4 hours per week only.

The yearly costs for personnel are calculated as follows:

$$P_a = P_n * G_a * \frac{td}{8} \quad \left[ \frac{\text{€}}{\text{a}} \right]$$

$P_a$	Costs for Personnel	€/a
$P_n$	Number of Staff Members	
$G_a$	Yearly Salary	€/a
$td$	Daily Working Time	h/d

## 12.2.5 Total Operation Costs

At the end the yearly operation costs consisting of energy costs, sludge disposal costs and costs for personnel are assembled and summarized.

The specific operation costs per population equivalent are shown in addition to the total operation costs.

## 12.2.6 Benefits of Anaerobic Digestion

If an anaerobic digestion is part of the design, its possible to produce electricity and heat. The electricity can be delivered to the power supplier for a fee. The heat can be used for the operation buildings. The fee of the electricity and the cost savings because of the use of the heat are listed at the end of the operating costs.

## 12.3 Load Variation

The oxygen transfer capability is described in the ATV M209 guideline. For pure water is the oxygen transfer capability specified in this text as the value is usually requested for analysis.

Oxygen transfer capability:

$$OP = \frac{OC}{P} \quad \left[ \frac{kg}{kWh} \right]$$

OC is the oxygen mass transferred into a pure water tank of given size within one hour by an aeration system at an oxygen concentration of  $C = 0$  mg/l, a water temperature of 20°C and under standard pressure (atmospheric normal pressure of 1,103 hPa).

Oxygen transfer into pure water (20°C):

$$OC = \frac{V * kLa_{20} * C_{s,20}}{1000} \quad \left[ \frac{kg}{h} \right]$$

$kLa_{20}$  is evaluated when measuring the oxygen transfer.

Here the oxygen transfer capability is evaluated based on the design data. The oxygen transfer is calculated analogue to the calculation for the air demand.

The following applies to the air demand, calculated from the oxygen demand, in the case of fine bubble compressed air ventilation:

$$Q_L = \frac{OC * 1000}{fO_2 * h_E} \quad \left[ \frac{m^3}{h} \right]$$

$Q_L$  Required air volume per hour [m<sup>3</sup>/h]

f <sub>O2</sub>	Oxygen transfer factor	[g/(m <sup>3</sup> *m)]
h <sub>E</sub>	injection depth	[m]
OC	Oxygen supply	[kg/h]

The hourly air volume is established by the selected blower. The oxygen transfer factor (oxygen transfer capacity, fO<sub>2</sub>) is a characteristic value of the selected aerator. The expected operating value may be entered into the form for the oxygen transfer capability. The value does not need to meet the dimensioning value as that often is preselected comprising safety ranges.

Oxygen supply:

$$OC = \frac{QL * fO2_{Operation} * hE}{1000} \left[ \frac{kg}{h} \right]$$

P is the power consumption of the aeration and the circulation units. It is useful to inquire about the power consumption of the circulation unit with the supplying company as it usually differs considerably from the rated power. The power consumption of the blowers is known from the data bank.

## 12.4 Pipelines

Choose **Extras > Pipelines**.

The diameters of the pipelines are calculated based on the flow velocity. Its not an hydraulical calculation.

The flow velocities for the evaluation of the pipeline diameters are available at General Constants in the folder Buildings/Equipment. In the frame Flow Velocities you can edit the velocity for water and air.

### Water Pipes

The connecting pipelines between the treatment building have to be designed for various water flows. The flow in the return sludge pipes depends on the return sludge ratio. The pipeline between activated chamber and secondary sedimentation has to transport the inflow and the return sludge.

### Air Support Pipelines

The air support pipeline system is usually very ramified. Here you get a list of the various diameters.

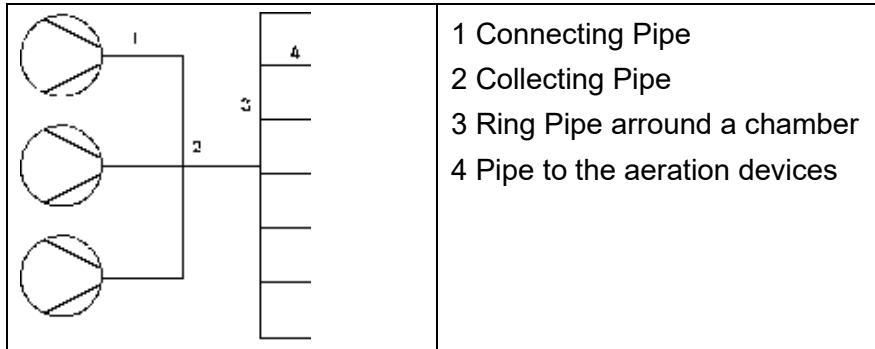

Fig. 143: Air supply pipeline system

## 12.5 Oxygen Efficiency

The oxygen efficiency is described in the ATV Paper M 209 /23/. Further information will be found at Wagner /28/.

Here the oxygen efficiency in pure water will be evaluated, because this parameter usually has to be verified.

### Definition

$$OP = \frac{OC}{P} \quad \left[ \frac{kg}{kWh} \right]$$

Also declared as SAE, Standard Aeration Efficiency.

OC is the amount of oxygen, which should be solved from a oxygen concentration  $C = 0$  mg/l, at a water temperature of 20 °C at an atmospherical pressure of 1,103 hPa within an hour into a chamber of a defined size, filled with pure water.

$$OC = \frac{V * kLa_{20} * Cs_{,20}}{1000} \quad \left[ \frac{kg}{h} \right]$$

$Kla_{20}$  will be evaluated by the oxygen input measuring.

### Membrane Aeration

AQUA DESIGNER evaluates the oxygen efficiency based on the design values. The oxygen supply will be calculated like in the calculation of the oxygen demand.

Calculation Data

<b>Blower</b>		<b>Spec. Oxygen Yield in Pure Water</b>	
Number of Blowers	2	Dimensioning	18,0 gO <sub>2</sub> / (m <sup>2</sup> *m)
Power Consumption per Blower	19,2 kW	Operation	<input type="text" value="18,0"/> gO <sub>2</sub> / (m <sup>2</sup> *m)
mechanical Losses	5,0 %	<b>Aeration Depth</b>	
Motor Efficiency	92,0 %	Aeration Depth	3,70 m
Electrical Power Consumption	21,9 kW	<input type="button" value="Calculate"/>	
Power Consumption, total	43,8 kW	<b>Result</b>	
<b>Mixers</b>		Hourly Oxygen Input	145,5 kgO <sub>2</sub> /h
Number of Mixers	2	<b>Oxygen Yield</b>	
Motor Power per Mixer	4,5 kW	Blower	3,32 kgO <sub>2</sub> /kWh
Motor Power, total	9 kW	Total Blowers and Mixers	2,75 kgO <sub>2</sub> /kWh
Power Consumption per Mixer	<input type="text" value="4,5"/> kW	<input type="button" value="Cancel"/> <input type="button" value="OK"/>	

Fig. 144: Oxygen efficiency

Air demand, evaluated from the oxygen demand:

$$Q_L = \frac{OC * 1000}{fO_2 * h_E} \left[ \frac{m^3}{h} \right]$$

QL	Hourly Air Supply	[m <sup>3</sup> /h]
fO <sub>2</sub>	Oxygen Transfer Capability	[g/(m <sup>3</sup> *m)]
h <sub>E</sub>	Immersion Depth	[m]
OC	Oxygen Demand	[kg/h]

The hourly air supply is defined by the selected blowers. The oxygen transfer capability is a parameter of the aeration device. The value in operation can be defined in the formular **Oxygen Efficiency**. It can differ from the design value, because often the design value is chosen with security factors.

Oxygen Input:

$$OC = \frac{QL * fO_{2operation} * hE}{1000} \left[ \frac{kg}{h} \right]$$

P is the power consumption of the blowers and mixers. For the mixing devices its recommend to request the aggregats by a supplier to get detaild values for the power consumption. The power consumption of the blowers is known out of the data bank. Mechanical losses and the efficiency of the motor are considered.

### Blowers

The coupling power is known out of the data bank. Mechanical losses are considered by a value of 5 %. Also important is the efficiency of the motor. At 5,5 kW you

can assume an efficiency of about 83 %. At 100 kW motor power the efficiency is about 95 %.

The power consumption can be estimated by

$$P_{A,el} = \frac{P_{Coupling} * 1,05}{\eta_{Motor}}$$

Following you find some average values of the motor efficiency of roots blowers.

2-pole Motors (3000 min<sup>-1</sup>)

Nominal power kW	4,0	11,0	45,0	110	500
Efficiency %	83	87	93,7	95,4	97

4-pole Motors (1500 min<sup>-1</sup>)

Nominal power kW	4,0	11,0	45,0	110	500
Efficiency %	83	86	93	95,1	96,8

## Surface Aeration

At Wagner /28/ you will find experimental evaluated models for the different aeration types.

Oxygen efficiency of horizontal axis aerators (rotors)

$$ON10 = 1,97 - 0,0058 * LD \left[ \frac{kgO_2}{kWh} \right]$$

Oxygen efficiency of vertical axis aerators in plug flow reactors

$$ON10 = 2,36 - 0,0121 * LD \left[ \frac{kgO_2}{kWh} \right]$$

(not statistical verified)

Oxygen efficiency of vertical axis aerators in mixed reactors

$$ON10 = 1,41 + 0,0055 * LD \left[ \frac{kgO_2}{kWh} \right]$$

## Mixing

If Mixers are selected, the power will be considered in the oxygen efficiency. Because the power consumption of the mixing will not be calculated in AQUA DESIGNER,



BITControl	AQUA DESIGNER 9.2 - Manual	Seite: <b>255</b> von 314
	12 Menu Extras	Version: <b>92-00</b>

here the nominal power is taken into account. If the power consumption is known by the suppliers data, you can enter this value into the input field **Power Consumption per Mixer**.

## 13 Menu Drawings

The true scaled drawings are a powerful component of AQUA DESIGNER to verify the way of design and to add drawings to your documentations. For an experienced engineer, the drawing will show immediately while calculating, whether the design is matching to his demands and all aspects are accurately.

The mass calculation and buoyancy supports you with additional information to proof economical aspects or to hand out additional information for the tendering.

### 13.1 Drawings

Clicking on **Drawings > Drawings > A 226/A131** the form for editing the true scaled drawings opens.

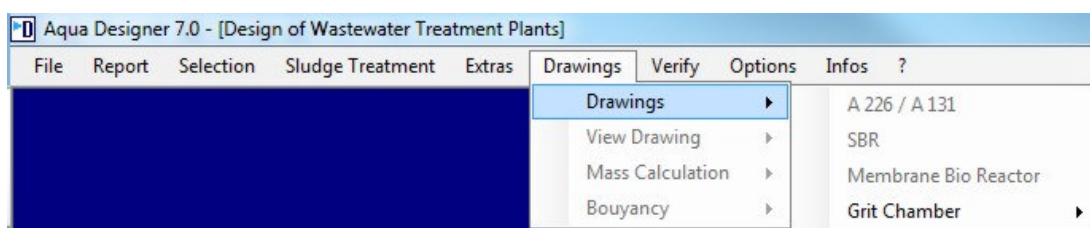

Fig. 145: Menu > Drawings

If you have designed separated chambers for sedimentation and activated chamber, an intermediate form will occur. Here you have to decide what chamber you want to display.

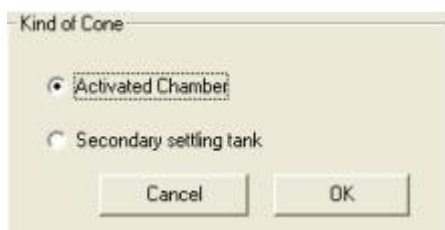

Fig. 146: Form Intermediate form for choosing activated or sedimentation chamber

Here for example, you want to see the activated chamber.  
After clicking OK the form for editing the drawings will occur.

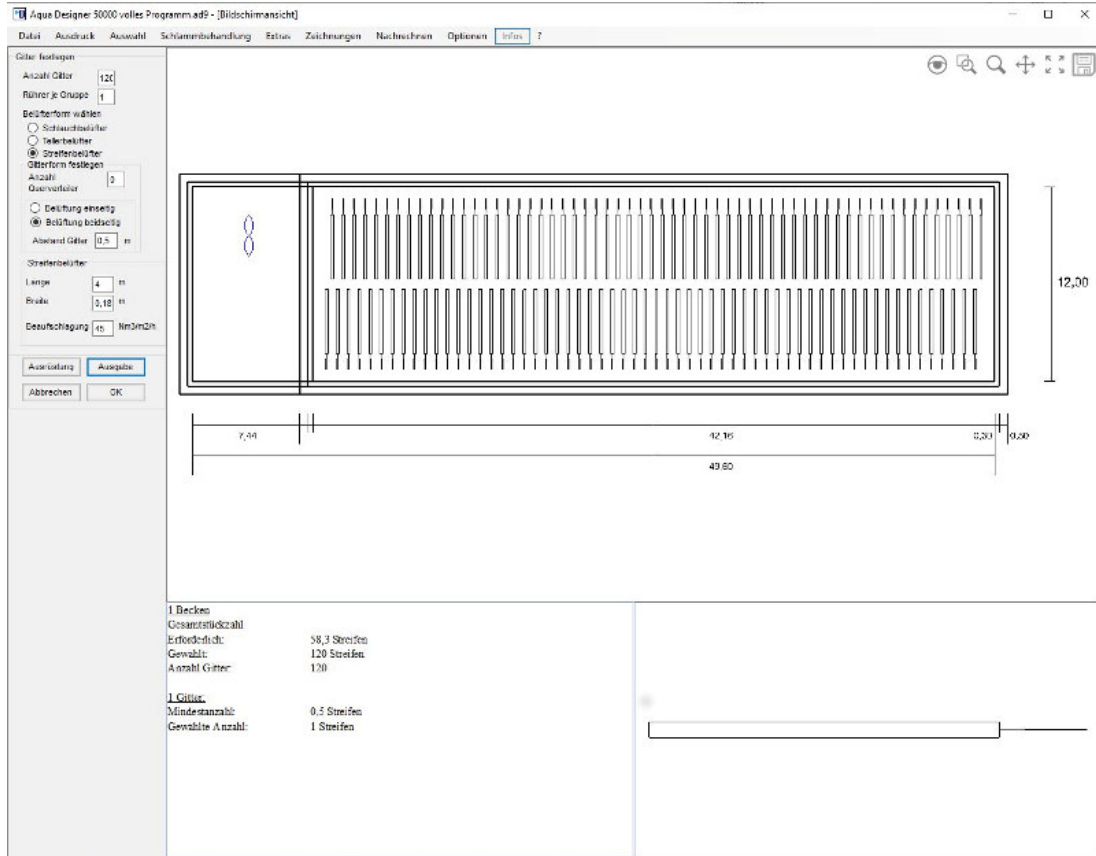

Fig. 147: Form drawings for activated chamber

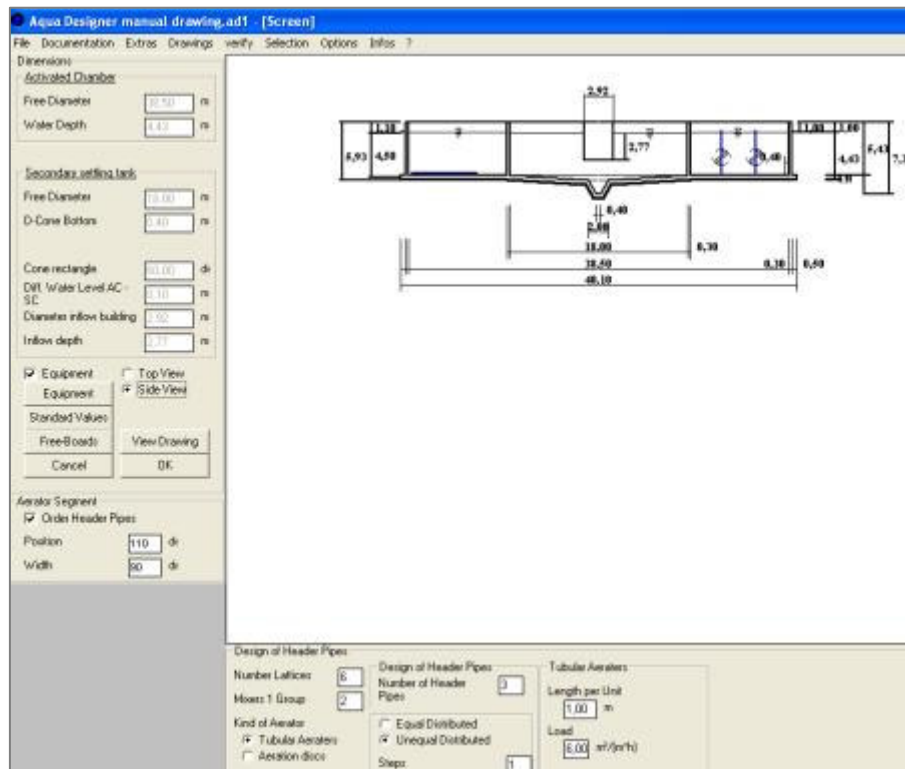

Fig. 148: Form drawings for compact chamber system

You are able to edit the true scaled drawings directly in AQUA DESIGNER. As the dimensions of the chamber are results of the design, these values are fixed. The diameter of the chambers cannot be changed after finishing the design. Also, if you have calculated a compact chamber, the thickness of the inner wall cannot be changed.

This value has to be pre selected before starting calculating. The value for the thickness of the wall of the sedimentation chamber can be edited in **Options > general constants > Buildings/Equipment > Data of the Building > Inner sedimentation tank > Wall thickness sediment. Tank.**

### 13.1.1 Fields

Dimensions

Activated Chamber

Free Diameter  m

Water Depth  m

Secondary settling tank

Free Diameter  m

D-Cone Bottom  m

Cone rectangle  dk

Diff. Water Level AC - SC  m

Diameter inflow building  m

Inflow depth  m

Equipment  Top View  
 Side View

Equipment

Standard Values

Free-Boards

Cancel

Aerator Segment

Order Header Pipes

Position  deg

Width  deg

Fig. 149: Editing the building

The dimensions of the building are only displayed. These values cannot be changed

in this form.

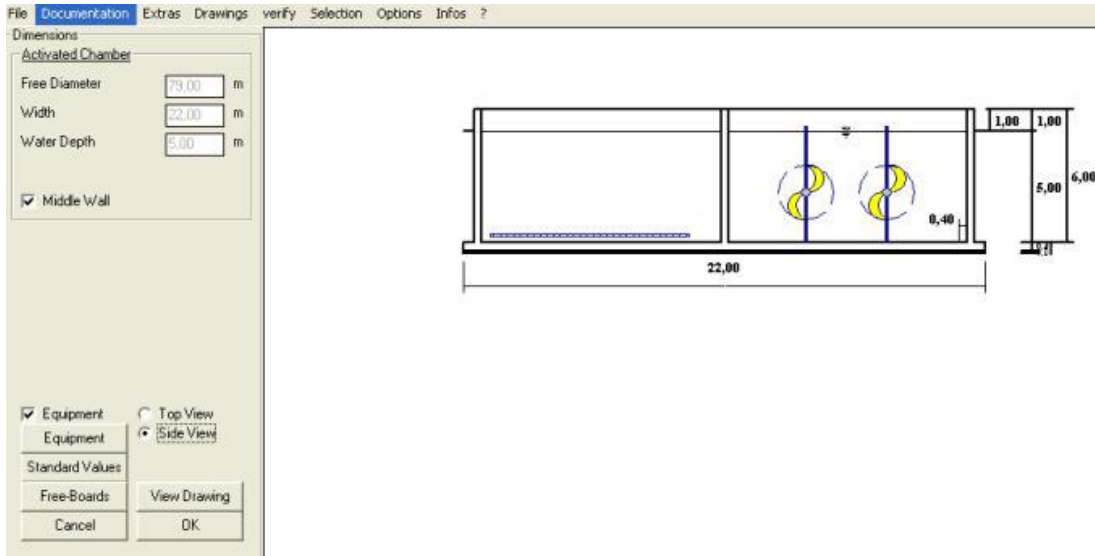
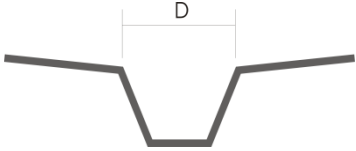

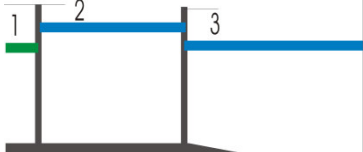
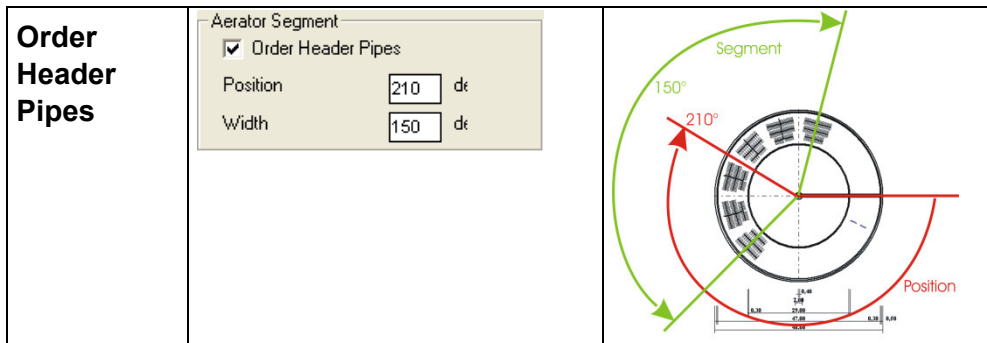

Fig. 150: form for oxidation ditch

<b>Middle Wall</b>	The <b>middle wall</b> can be inactivated. After inactivating, the middle wall will be removed.	
<b>Equipment</b>	The aeration system and the mixers are displayed in the drawing, for example to verify whether the dimensions are fitting to the size of the chamber. By inactivating the label Equipment, only the building will be drawn.	
<b>Buttons</b>	Values to be edited are available by the buttons Equipment, Standard Values and Free-Boards.	
<b>Equipment</b>		<p>Distance to Wall Distance of the lattice to the outer ring wall. Distance of the Tubes Distance between the aeration tubes, fixed on the header pipes. Distance of Discs As before for aeration discs Mixers Its strongly recommended to let enough space between the mixer and the aeration equipment. This space can be edited here.</p>

<p><b>Standard Values</b></p>	<p>Standard Values</p> <p>Activated Chamber</p> <p>Thickness Wall Activated Chamber <input type="text" value="0,30"/> m</p> <p>Secondary settling tank</p> <p>Wall thickness sedimentat. tank <input type="text" value="0,30"/> m</p> <p>Diameter Sludge Cone <input type="text" value="2,00"/> m</p> <p>bottom height</p> <p>Slope of Bottom <input type="text" value="3,78"/> deg</p> <p>bottom thickness <input type="text" value="40,00"/> cm</p> <p>Width of Spur <input type="text" value="50,00"/> cm</p> <p>Base Concrete <input type="text" value="10,00"/> cm</p> <p>W x L low point <input type="text" value="40,00"/> cm</p> <p>Cancel OK</p>	<p><b>Thickness Wall Activated Chamber</b> Outer Wall of an activated or combined chamber system.</p> <p><b>Wall thickness sedimentation tank</b> Outer wall of a sedimentation tank, or inner wall of a combined chamber system. In combined chamber systems this value can only be edited before starting the calculation in the form general constants.</p> <p><b>Diameter Sludge Cone</b></p>  <p><b>Width or the Spur</b></p>  <p><b>WxL low point</b> At the low point you can de-water the chamber.</p>
<p><b>Free Boards</b></p>	<p>Free-Boards</p> <p>Outer free-board <input type="text" value="1,00"/> m</p> <p>Inner Free-Board Activated Chamber <input type="text" value="1,00"/> m</p> <p>Inner Free-Board Sedimentation Chamber <input type="text" value="0,00"/> m</p> <p>Cancel OK</p>	 <p>1 outer free board 2 inner free board activated chamber 3 inner free board sedimentation chamber</p>



## Tools for Drawings

In the upper right corner you will find menus to work with the drawings. First there are some zoom functions.

### The magnifier

Click the symbol. The move over the drawing and a circular detail will be enlarged.

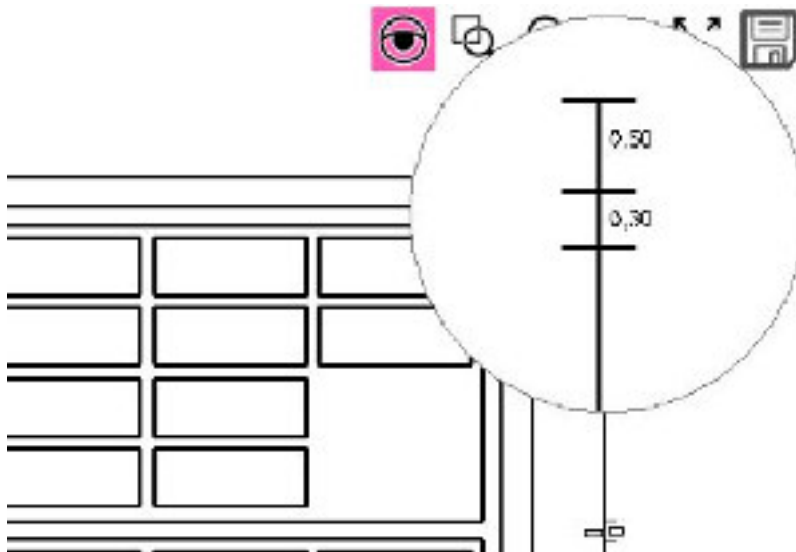

Fig. 151: Form drawings, magnifier

### The zoom rectangular

Click the symbol for the zoom rectangular and draw a rectangular in the drawing area.

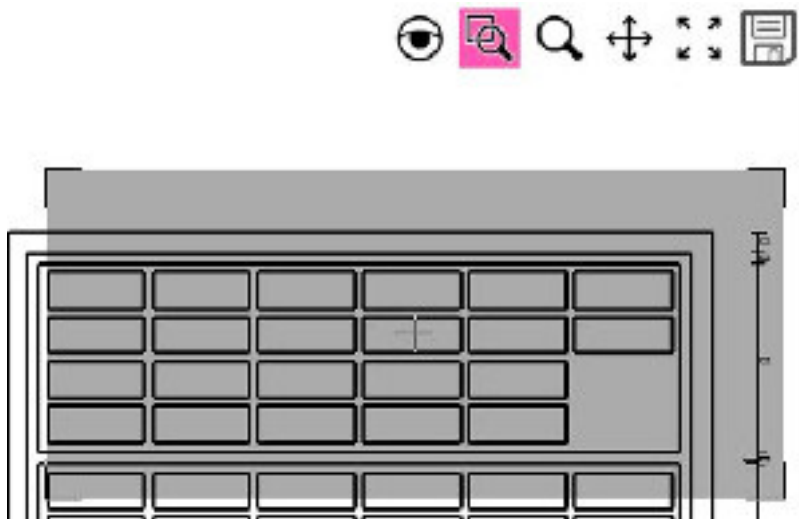

Fig. 152: Form drawings, rectangular enlargement

#### The dynamic magnifier

Click the dynamic magnifier. Now you can change the size by moving the magnifier.

#### Move the drawing

Click the Move symbol. Now you can move the drawing in the drawing area.

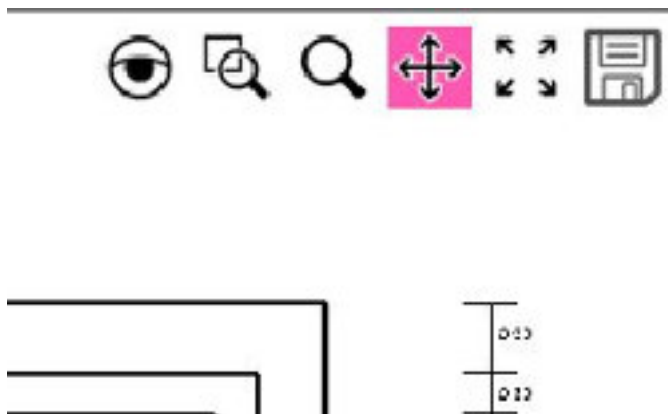

Fig. 153: Form drawings, move the drawing

#### Positioning

Click on the symbol and the drawing will be adapted to the drawing area.



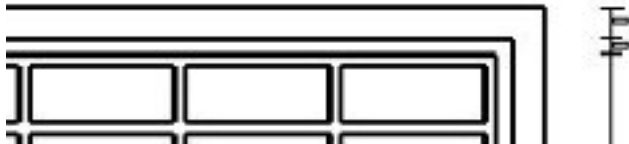
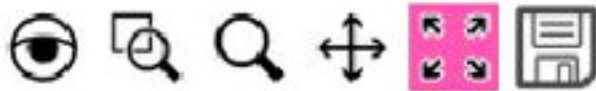

Fig. 154: Form drawings, positioning the drawing

### Export

By saving the drawing, you are able to chose several formats.

- dwg, dxf, bmp, emf, gif, jpg, png, tif

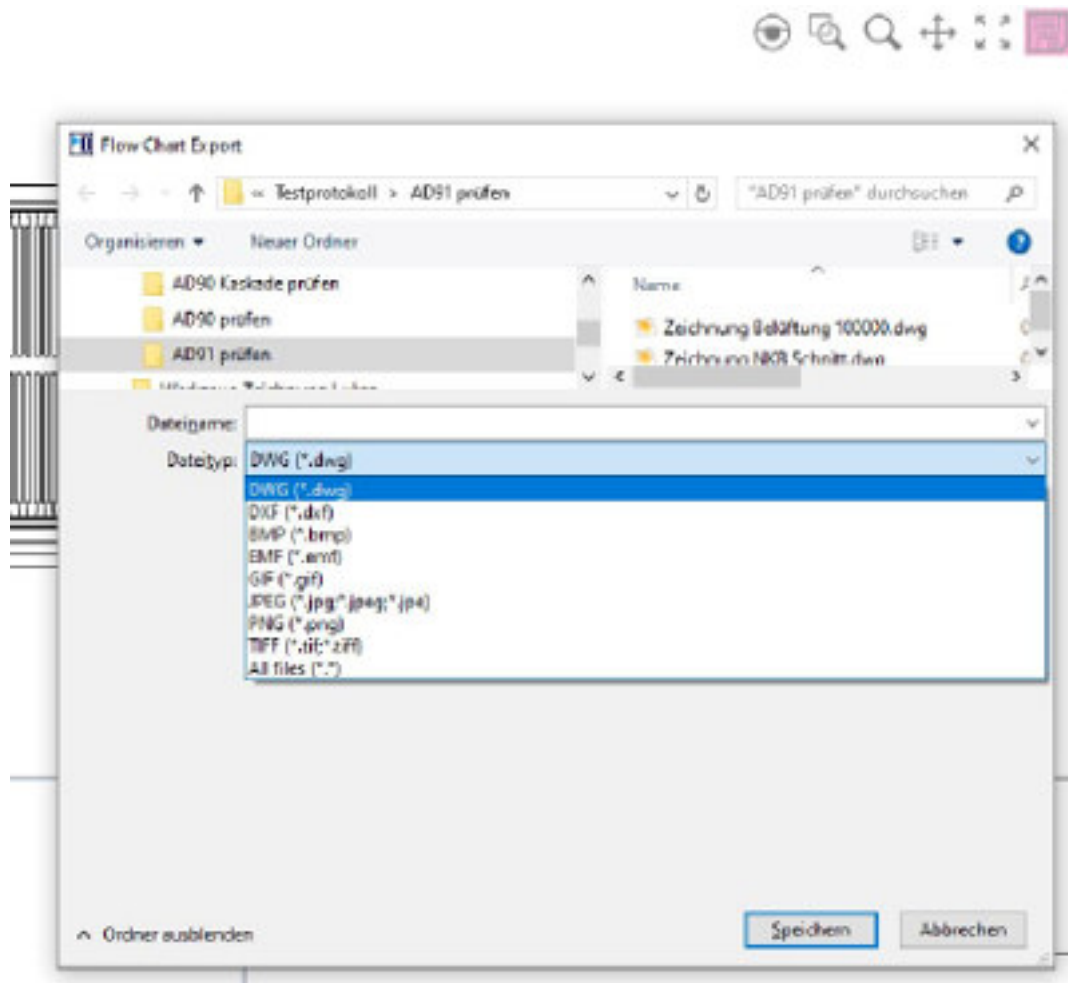

Fig. 155: Form drawings, save and export

### 13.1.2 Membrane Aeration System

After calculating the oxygen and air demand for suppressed air systems and selecting blowers and mixers, the aeration and mixing system is displayed inside of the activated chamber also as true scaled drawing.

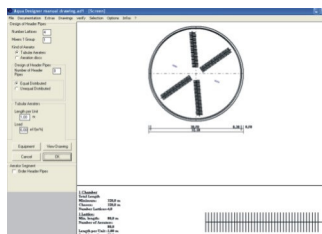

Fig. 156: Activated chamber aeration system

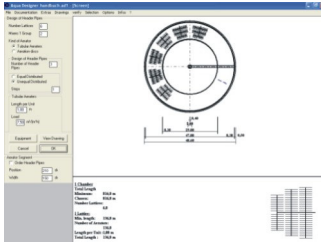

Fig. 157: Combined chamber system, aeration placement

The form opens in Top View modus. The properties of the aeration system can be edited on the left side. At the bottom part of the form, a detailed drawing of one aeration lattice is displayed.

### 13.1.3 Control Picture

At the calculation step for the sedimentation tank and at the activated chamber you are able to view the design of the chamber.

After calculating a sedimentation chamber or an activated chamber press the button Control Picture.

A true scaled drawing of the chamber will appear.

You are able to display as top view or side view.

### 13.1.4 Output of Drawings

You are able to Print the drawings, or to export them as a DXF-File.

For output of the drawings you have to open the form drawings with **Drawings > drawing** or with **Control Picture** or in **Membrane Aerator**.

After the drawing is displayed on the screen, select **Drawings > View Drawing > Print or DXF**.

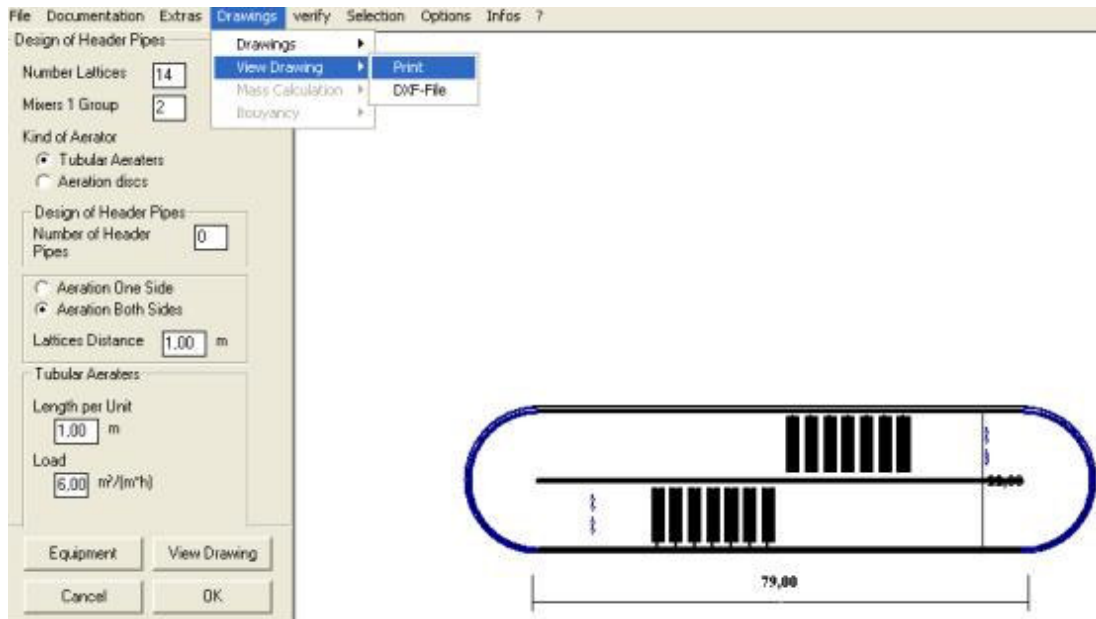

Fig. 158: Menu for output of drawings

## 13.2 Flow diagram

After calculating a complete project, a flow scheme can be generated according to the way of design.

The flow diagram concludes all components calculated and selected by the components selection (see **Extras – Components**).

### 13.2.1 Grit and Grease Chamber, Primary Sedimentation and biological Trap

If by **Selection > Grit and Grease Chamber** this process unit has been calculated, this automatically is inserted into the flow diagram. The selected numbers of machines is matching to the way of design.

The same is for primary sedimentation and biology. Also here the number of lines and machines and kind of machines is displayed in the diagram.

### 13.2.2 Further process units

Process units which are not calculated in AQUA DESIGNER can be added by **Extras > Components**.

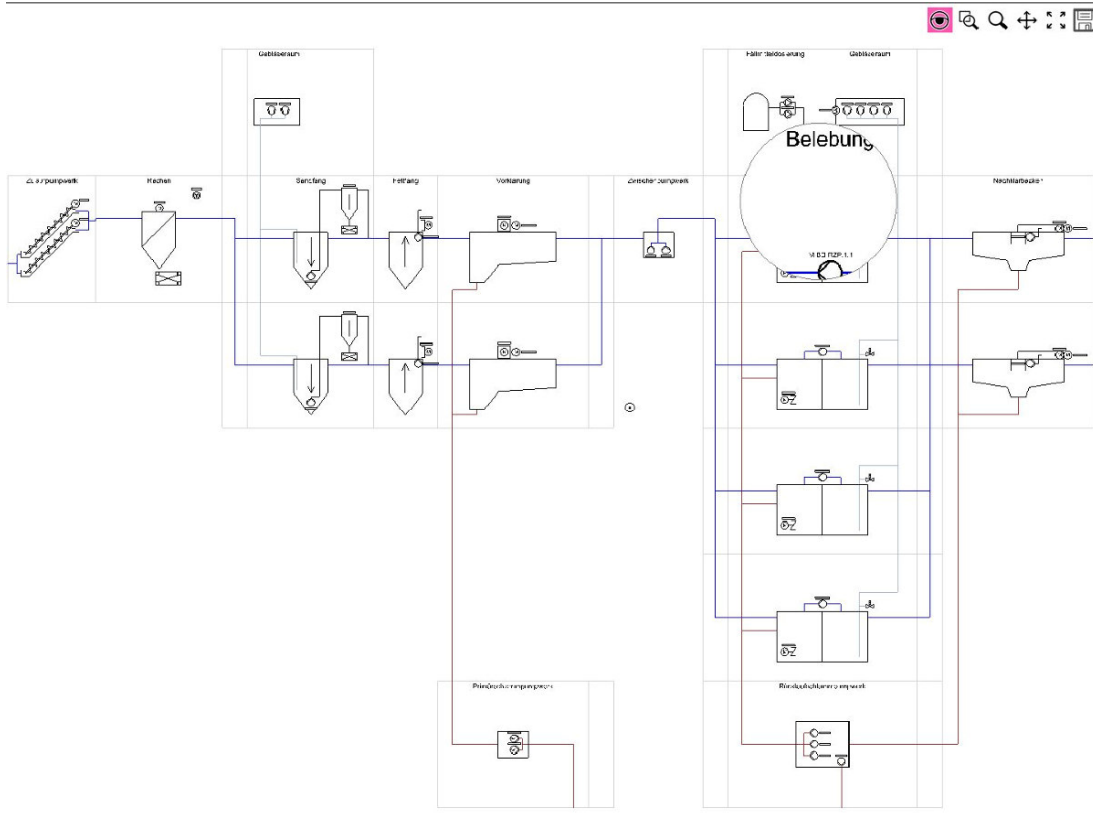

Fig. 159: flow diagramm / example

### 13.2.3 Export

By the save function ist possible to save several formats.

DWG, DXF, BMP, EMF, GIF, JPG, PNG, TIF

## 13.3 Mass Calculation

Before calculating the masses of concrete and excavation you may edit the drawing. The masses are based on the chosen values for wall thickness, spur and free boards.

Clicking on **Drawing > Mass Calculation > A226 / A131** the form for mass calculation opens.

Chamber	
Activated Chamber	
Wall thickness	30 cm
bottom thickness	40 cm
Width of Spur	50 cm
Outer free-board	1,00 m
Inner freeboard	1,00 m
Secondary settling tank	
Wall thickness	30 cm
Inner freeboard	1,10 m
Excavation	
Slope of the Pit	<input type="text" value="45"/> °
Work Space	<input type="text" value="1,0"/> m

Cancel      OK

Fig. 160: Form for mass calculation

Only the values for the Slope of the Pit and the Work Space has to be selected. Then, all information for calculating concrete and excavation is provided.

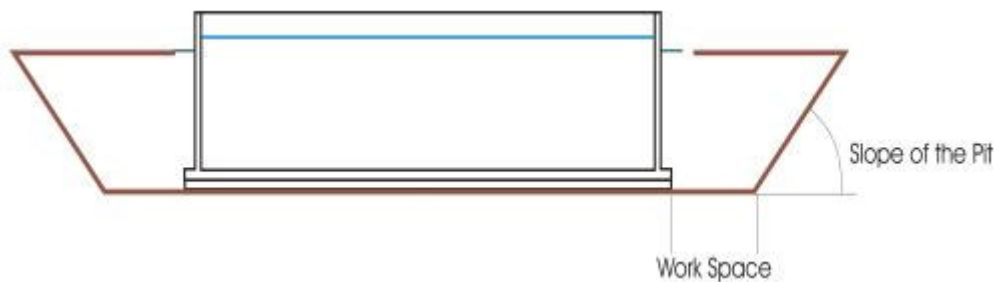

Fig. 161: Pit for activated chamber

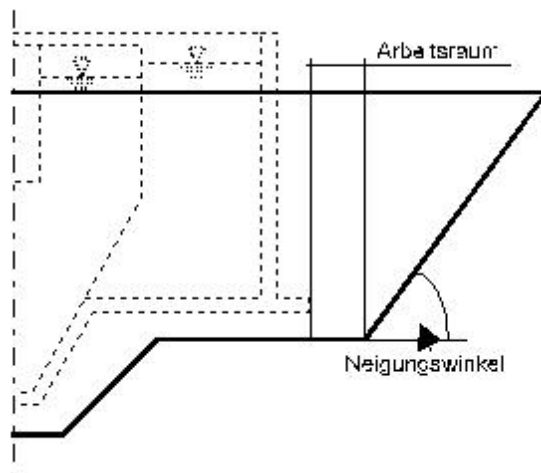

Fig. 162: Pit for compact chamber

Neigungswinkel = Slope

Arbeitsraum = Work Space

## 13.4 Bouyancy

Before calculating the bouyancy for a chamber you may edit the drawing. The masses are based on the chosen values for wall thickness, spur and free boards. Clicking on **Drawings > Bouyancy > A 226/A131** the form for **bouyancy** opens.

Chamber	
Activated Chamber	
Wall thickness	30 cm
bottom thickness	40 cm
Width of Spur	50 cm
Outer free-board	1,00 m
Inner freeboard	1,00 m
Secondary settling tank	
Wall thickness	30 cm
bottom thickness	30 cm
Width of Spur	50 cm
Outer free-board	1,00 m
Inner freeboard	0,00 m
Calculation Parameter	
Spec. Weight of Solids	<input type="text" value="1,5"/> kg/l
Specific Weight of Concrete	<input type="text" value="2,5"/> kg/l
Friction rectangel	<input type="text" value="0"/> °
Cancel <input type="button" value="OK"/>	

Fig. 163: Form for calculation of bouyancy

The weight of the technical equipment will not be considered.

The bouyancy will be calculated based on the mass of the building. The resulting permitted ground water level is ment for an empty chamber.

If there is chosen a spur, the concrete of the spur and also the soil mass on the spur is considered for the mass of the chamber.

The friction rectangle depends on the properties of the soil.



## 14 Menu Verify

### 14.1 Generell

With the help of the Recalculation menu you are able to assess the actual (theoretical) capacity of the currently operating wastewater plant or of parts of the plant.

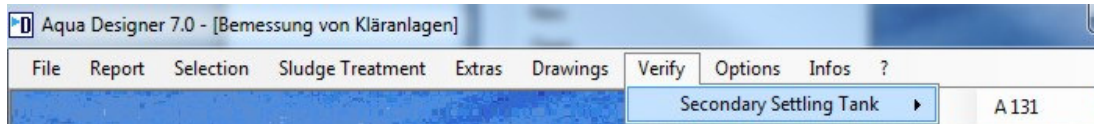

Fig. 164: Menu > Verify

The actual capacity of many of the existing plants is not known as they were dimensioned on the basis of currently outdated regulations. It is, therefore, necessary to recalculate the plant capacity on the basis of the most current regulations for any expansion or addition of lines.

For this purpose, the previously demonstrated dimensioning process is reversed. This means that based on the evaluated dimensions, the permitted charges and loads are recalculated.

### 14.2 Secondary Sedimentation Tank

It is possible to recalculate existing sedimentation chambers based on the DWA guidelines A 226 and A131. The data for dimensioning the surface area and the water depths are entered first. The permitted hydraulic load of the existing chamber is calculated from the selected MLSS for the activated sludge chamber, the return sludge ratio and the data for the sludge characteristics.

#### 14.2.1 Calculation

##### Surface Area

You have the choice of circular, rectangular or hopper-bottom tanks.

Choose **Other** Tanks and enter a surface when the existing type of tank is not listed.

##### Flow

You can choose the **Vertical** or **Horizontal Flow** option for recalculating an existing circular chamber.

For a deep sedimentation chamber, it is useful to examine the possibility of calculating a vertical flow sedimentation.

Choose **Vertical Flow** in the **Flow** window to calculate this variation.

The present sedimentation chamber will now be considered a vertical flow sedimentation tank. The sludge volume loading is preselected as 650 l/(m<sup>2</sup>\*h). AQUA DESIGNER calculates the inflow depth in accordance with the applicable guideline and examines the feasibility of vertical flow for the chamber. If the preconditions for a vertical flow tank are not satisfied, AQUA DESIGNER will not continue with the computation. At this point, change to the **Horizontal Flow** option to continue the calculation.

Input

Form of the Tank

Round Tank       Hopper Tank

Rectangular Tank       Other

Round Tank

Flooding

Horizontal       Partly vertical       Vertical

Diameter	15,00	m
Water Depth (Border)	4,00	m
Water Depth (Central Build.)	5,00	m
Diameter of Inflow building	2,00	m
Inflow Depth	3,00	m

Calculate

Fig. 165: Existing Circular Chamber

For a horizontal flow sedimentation tank the sludge load volume is preselected as  $q_{sv} = 450 \text{ l}/(\text{m}^2 \cdot \text{h})$ .

A hopper-bottom tank is calculated as vertical flow chamber by the program.

Rectangular tanks and tanks entered into the **Other Tanks** option are calculated as horizontal-flow chambers.

For rectangular sedimentation tanks the disturbing or inlet zone is not included into the effective surface area. According to the ATV, the water depth will be suggested as length of this zone. Please see the part on Secondary Sedimentation tanks as Rectangular Tanks in the Dimensioning Chapter as well.

## Water Depth

The peripheral water depth and the water depth at the central inlet is required for calculating the secondary sedimentation tank slope. The slope and the total depth at 2/3 of the flow distance are calculated from the peripheral and central water depths.

### Central Inlet

The volume of the existing inlet has to be considered in subtracting it from the total volume if it remains in operation. Therefore, the corresponding dimensions have to be entered.

### Channel System

The return sludge ratio is selected depending on the type of channel system. For a combined sewerage system, the maximum RS will be  $0.75 * Q_m$  for the dimensioning. See also the chapter **Dimensioning > Basic Data**.

### Dry Solid Matter

In addition to the data on the dimensions of the building, data on the mixed liquor suspended solids MLSS are needed.

The solids concentration in the activated sludge chamber and the selected return sludge ratio determine the required degree of thickening in the sedimentation chamber.

The sludge volume index ISV determines the sedimentation characteristics of the sludge.

The factor TSRS/TSBS demonstrates the degree of impairment of the thickening process by sludge removal devices.

Further information is available in the chapter Dimensioning under the keyword Load.

## 14.2.2 Proof

The proof is calculated analogous to the calculation of sedimentation tanks previously described in the Sedimentation chapter. The calculation is reversed using the data on the existing dimensions.

### DWA-A 226:

The permitted maximum inflow is calculated based on the surface area.

For horizontal flow:

For the sludge volume loading:

$$q_{sv} = 450 \left[ \frac{l}{m^2 * h} \right]$$

For the surface loading:

$$qA = \frac{qsv}{SSAT * ISV} \left[ \frac{m}{h} \right]$$

For strom water inflow:

$$Qmz = qA * A_{NB} \left[ \frac{m^3}{h} \right]$$

### 14.2.3 Hints

A hint appears when an existing horizontal flow sedimentation tank can also be calculated as a vertical flow chamber. This is the case for an inflow depth larger than half the horizontal flow distance.

A hint appears when the vertical flow option has been selected and the condition of inflow > flow distance/2 is not fulfilled. The program will not allow you to continue the calculation with the vertical flow option.

A hint appears when the conditions for minimum depths are not guaranteed. Again the program will not allow you to continue the calculation.

The following minimum depths are required:

Peripheral Depth: >= 3.5 m

Total Depth: >= 4.0 m

Hopper-bottom Tanks:

Height Cylinder: >= 1/3 Height Cone

Height Cylinder >= 2.0 m for separated sewer system

Height Cylinder >= 3.0 m for combined sewer system

### DWA-A131

The levels of the sedimentation chamber liquid zones for the present sedimentation chamber are evaluated using an iteration with qsv and qA until the total depth corresponds with the liquid level zones.

The sludge thickening time and the sludge concentration factor are calculated on the basis of the entered values for the MLSS in the activated sludge chamber, the return sludge ratio and the sludge volume index.

$$SS_{RS} = \frac{SS_{AT} + SS_{AT} * RV}{RV} \left[ \frac{kg}{m^3} \right]$$

$$SS_{BS} = \frac{SSRS}{SSRS / SSBS} \left[ \frac{kg}{m^3} \right]$$

$$tE = \left( \frac{SS_{BS} * ISV}{1000} \right)^3 [h]$$

BITControl	AQUA DESIGNER 9.2 - Manual	Seite: <b>275</b> von 314
	14 Menu Verify	Version: <b>92-00</b>

$$C = 300 * tE + 500 \quad [\text{kg/m}^3]$$

The maximum qsv is 450 l/(m<sup>2</sup>\*h) for the horizontal flow sedimentation and 600 l/(m<sup>2</sup>\*h) for the vertical flow sedimentation.

A hint appears when an existing horizontal flow sedimentation tank can also be calculated as a vertical flow chamber. This is the case for an inflow depth larger than half the horizontal flow distance.

A hint appears when the vertical flow option has been selected and the condition of inflow > flow distance/2 is not fulfilled. The program will not allow you to continue the calculation with the vertical flow option.

A hint appears when the conditions for minimum depths are not guaranteed. Again the program will not allow you to continue the calculation.

The following minimum depths are required:

Peripheral Depth: 2.5 m

Total Depth: 2.0 m

## 15 Menu Options

### 15.1 Language

Click on **Menu > Options > Language** and choose one them.

If you change from a CE (central european)-font to the chinese or the cyrillic font, you first have to activate the according font on your PC and to make a new start of your PC.

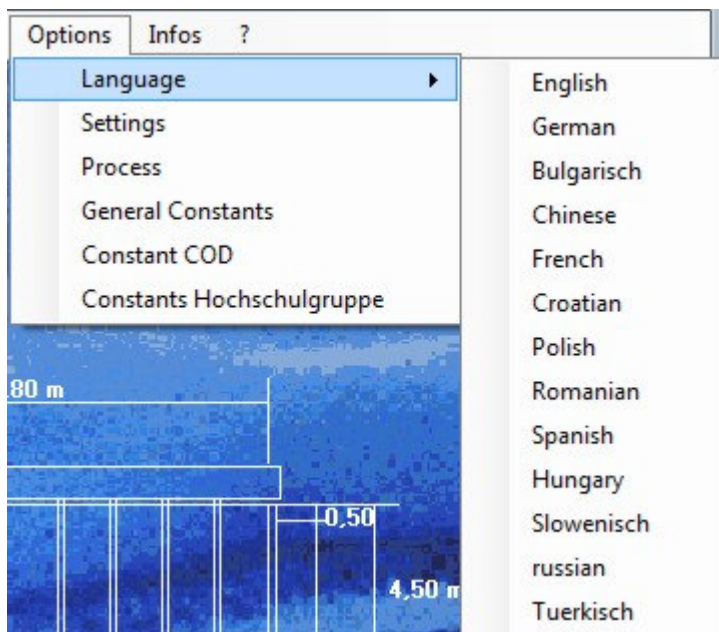

Fig. 166: Menu > Options > Language

### 15.2 Settings

Click on **Menu > Options > Settings**. A formular to choose different parameter for the calculation process or the documentation appears.

#### 15.2.1 Options

##### Multiline

Clicking on **Multiline** the program allows you to calculate several parallel lines in the biological step. Selecting **Multiple Lines** the option is marked.

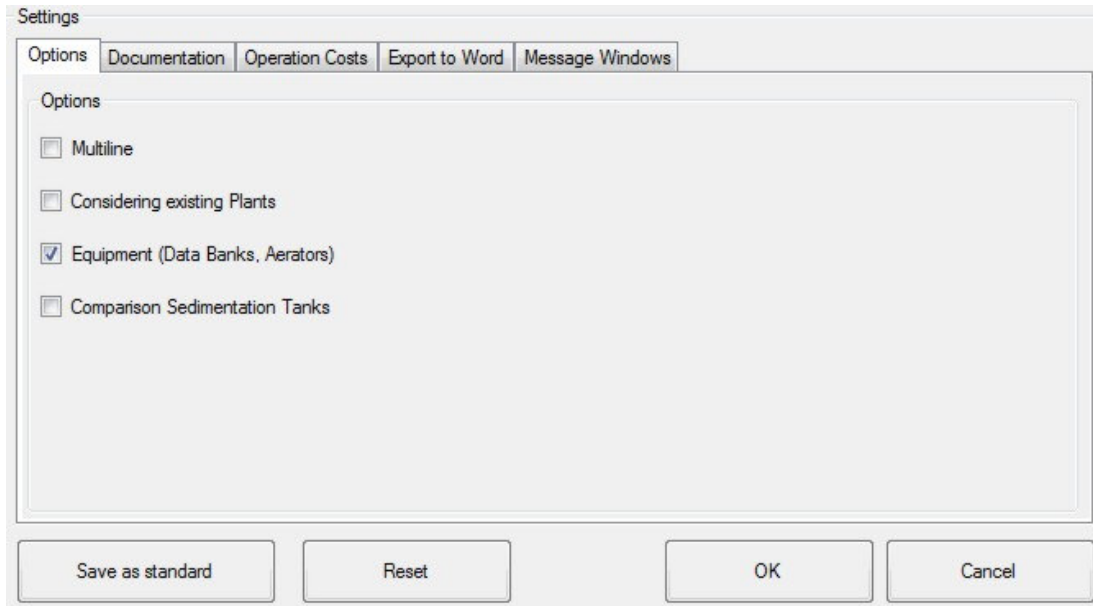

Fig. 167: Menu Options > Settings > Options

Intermediate windows will appear for the **Multiple Lines** and the **Incorporating Existing Plant Components** in the **Options** asking you for the number of lines to be installed for the secondary sedimentation tanks or the activated sludge tanks.

### Secondary Sedimentation Tank

Select a sedimentation chamber by clicking on the according field after completing the **Basic Data** form. If the **Multiple Lines** option has been selected, an intermediate window will appear. Here the desired number of parallel lines or chambers is entered.

Clicking on OK, the familiar form for calculating secondary sedimentation chambers will appear.

All data in this form are linked with one secondary sedimentation chamber. The dimensioning is based on the wastewater inflow volume for one line.

It is only possible to calculate parallel lines of the same size.

Preexisting lines that are incorporated into the dimensioning may differ from the size of new constructed lines.

### Activated Sludge Tank

Enter the desired number of parallel lines or chambers into the field **Number of Activated Sludge Chambers** of the intermediate window. In the form for the dimensioning of activated sludge chambers one chamber is calculated only based on the load for one line. All data in this form are linked to one line or one chamber.

## Aeration

The oxygen demand and required air volume is calculated for the entire wastewater plant and displayed accordingly.

## Blower

The number of blowers for the entire wastewater plant is listed in the field: **Number of Blowers**. The default value is set for two blowers for each line. You may enter any number of blowers. For example 8 blowers are suggested by AQUA DESIGNER when choosing 4 lines. It is, however, possible to set 3 blowers for 4 lines. The total capacity of all blowers chosen from the databank will be equally distributed over all the lines.

## Mixer

One mixer is selected for each line. The number of mixers entered must be dividable through the number of lines. For example you will enter 4, 8, 12 or 16 mixers when choosing four lines.

## Aeration

In the Aeration form all the values are based on one sedimentation tank only. Also the result display for one aeration screen in the lower right window is calculated for one sedimentation tank only.

## Considering Existing Plants

Existing plant components may be incorporated into the calculation of new lines or the expansion of an existing plant.

Click on **Options > Incorporate existing Plant**.

A form appears in the **main window** after clicking on **Secondary Sedimentation Tank** and **Activated Sludge Tank** as before with choosing the option **Multiple Lines**.

## Sedimentation Tanks

Click on **(Re)Calculate Existing (Secondary Sedimentation) Tank** in the **Existing Sedimentation Tank** window. You can recalculate an existing secondary sedimentation tank with this procedure and include the result into the design.



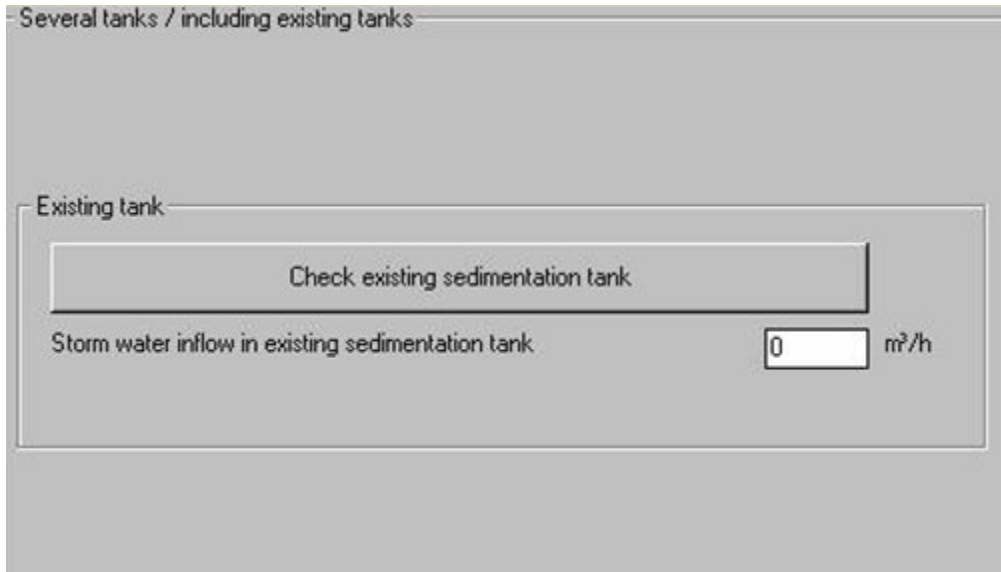

Fig. 168: Intermediate windows for taking existing sedimentation tanks into account

Operational instructions for the Recalculation forms were previously available in this chapter under the keyword Recalculation.

Values like the sludge volume index or the return sludge ratio that were entered previously into the form Basic Data will be only displayed in this section and cannot be changed anymore.

The resulting hydraulic load is displayed in the form **Recalculation**. You may accept the displayed result in the field **Selected Combined Wastewater Inflow** (Qmz) or enter another value. For example, it may be helpful to enter half the hydraulic load at this point when the construction of a second line of the same size is planned.

The value entered in the field for **Selected Combined Wastewater Inflow** (Qmz) is incorporated into the computation and deducted from the total inflow. The dimensioning of one or more secondary sedimentation tanks is conducted with the remaining inflow.

The remaining inflow will be divided by the the number of selected lines when **Multiple Lines** were selected. Therefore, it is possible to incorporate an existing tank into the computation or calculate an expansion with an increase in the number of lines.

### Activated Chamber

Similar to the dimensioning of the sedimenation tanks you can incorpore an existing activated sludge tank in the dimensioning of the activated sludge chamber. Values previously entered in the form Basic Data cannot be changed at this point.

The BOD5 load of the existing plant will be substracted from the total BOD5 load. The new chambers/tanks will be dimensioned for the remaining BOD5 load.

### Aeration

Calculating the oxygen intake and supply there is again the choice of only

calculating the capacity for an existing plant or to calculate the required aeration capacity for the total load of a new plant.

Clicking on the control box as demonstrated in the picture above, the fraction of the existing plant will not be included in the calculation for the new plant.

Leaving the control box blank, the aeration for the new activated sludge tanks is calculated based on the total load.

## Return Sludge Transport

As described above it is again possible to incorporate existing plant components in the calculation of the return sludge transport.

Selecting the according control box, the capacity of the existing plant components will be subtracted from the computation of the new construction. (oder: included in the dimensioning of the new return sludge transport facility.) However, leaving the control box blank the return sludge transport is calculated for the entire wastewater inflow accessing the according form or clicking on the according option in the Comparative Window.

## Equipment

If you have to calculate a project very fast und don't need the equipment, deactivate the control box **Equipment (Data Banks, Aerators)**.

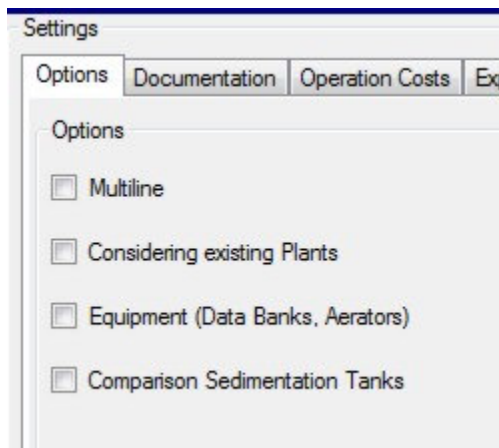

Fig. 169: Options: Design without Equipment

## Comparison Sedimentation Tanks

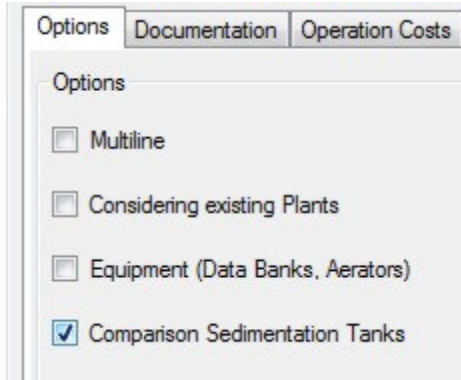

Fig. 170: Options: Comparison Sedimentation Tanks

It is possible to dimension several secondary sedimentation tanks in parallel. In the right part of the Main Window the **Comparison NB** part is active for comparing the dimensioning of several secondary sedimentation tanks.

The number of possible choices for secondary sedimentation tanks is based on the selected ATV guideline. Calculating a plant based on the A 226 /58/ all secondary sedimentation tank variations according to the A 226 and A131 are at your choice. Calculations based on the A131 allow only the secondary sedimentation tank variations according to the A131.

This is based on the permitted choices in the ATV guidelines.

Two secondary sedimentation tanks are compared in each step. Having calculated three secondary sedimentation tanks the tanks of same type or the tanks based on the same ATV guideline are compared with each other.

A 126/A 131 vertically flooded sedimentation tanks				
	Vertical sedimentation chamber			
	A 126		A 131	
Total height	10,45	m	10,12	m
Surface	63,62	m	95,03	m
Volume	350,03	m <sup>3</sup>	385,76	m <sup>3</sup>

A 126 horizontal  
 A 126 vertically flooded sedimentation tanks  
 A 131 horizontal  
 A 131 vertically flooded sedimentation tanks

Fig. 171: Comparison of Secondary Sedimentation Tanks

**Example:**

Calculate the vertical-flow secondary sedimentation tank based on the ATV A 226 /58/ and ATV A131. In the right part of the **Main Window** the field **Comparison NB** with the field **vertical A 226/A131** is activated.

Additionally calculate the horizontal-flow secondary sedimentation tank based on the A 226. Now the fields **A 226 horizontal/vertical** and **vertical**

**A 226/A131** are activated.

Clicking on any active field opens a window that compares selected values of the secondary sedimentation tanks. Select one of the computed secondary sedimentation tanks by clicking on the according option field.

Without an individual selection at this time the very first computed secondary sedimentation tank is preselected by the program.

Leave the window by clicking on **OK**.

The dimensions of the selected tank are used for the subsequent computation.

**Example:**

Calculate the vertical-flow secondary sedimentation tank based on the ATV A 226 and ATV A131. In the right part of the **Main Window** the field **Comparison NB** with the field **vertical A 226/A131** becomes activ.

Additionally calculate the horizontal-flow secondary sedimentation tank based on the A 226. Now the fields **A 226 horizontal/vertical** and **vertical A 226/A131** are activ.

Clicking on an activ field opens a window with comparative values for the secondary sedimentation tanks. Choosing an option field one of the computed secondary sedimentation tanks is selected.

Without an individual selection the very first computed secondary sedimentation tank is preselected by the program.

Leave the window clicking on **OK**.

The values of the selected tank are used for the subsequent computation.

## 15.2.2 Documentation

If you chose these items they will appear in the documentation.

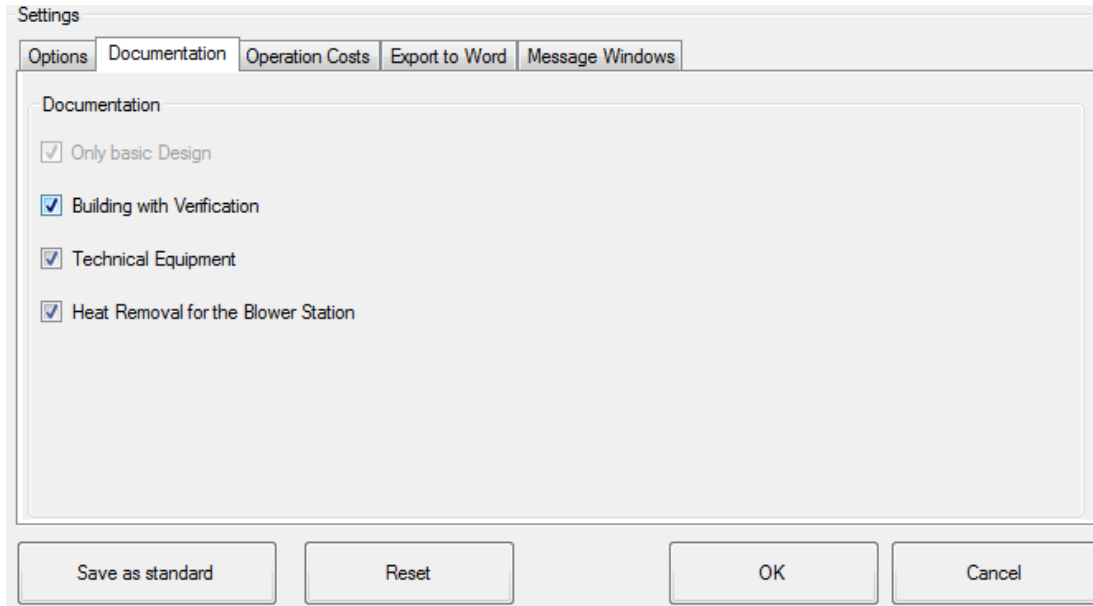

Fig. 172: Options > Settings > Documentation

### 15.2.3 Operation Costs

As in Documentation, some items can be selected.

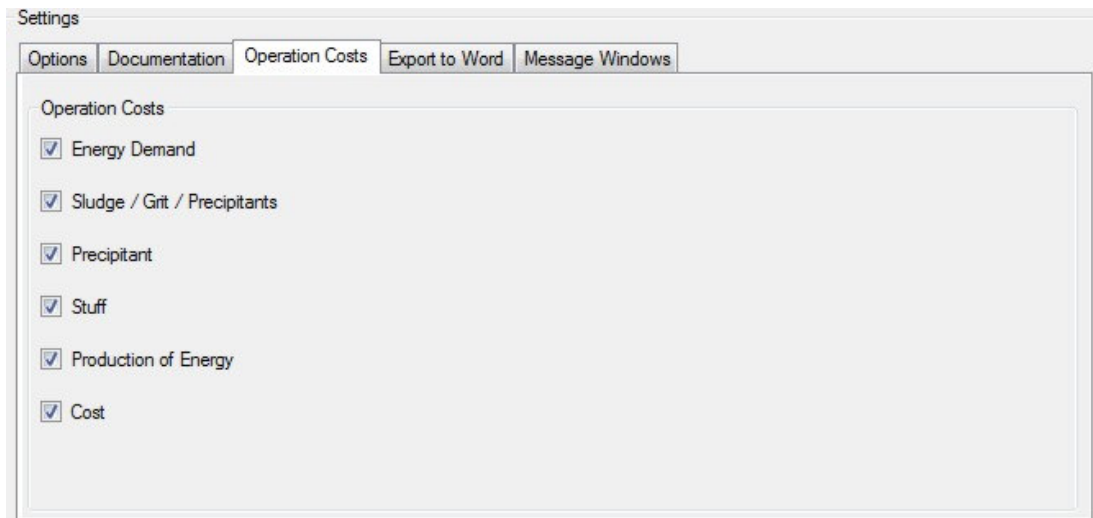

Fig. 173: Options > Settings > Operation Costs

### 15.2.4 Export to Word

All Documentation can be exported to Word. If the Formular Editor is not installed, instead of the formulas an Error will appear. In the chineases language version this also can occur if you work with an chineases operation system.

If its not possible to solve this problem in Word, you are able to change the export conditions for formulas.

## 15.2.5 Message Window

In the **Message Window** you can activate a message window for the SBR calculation.

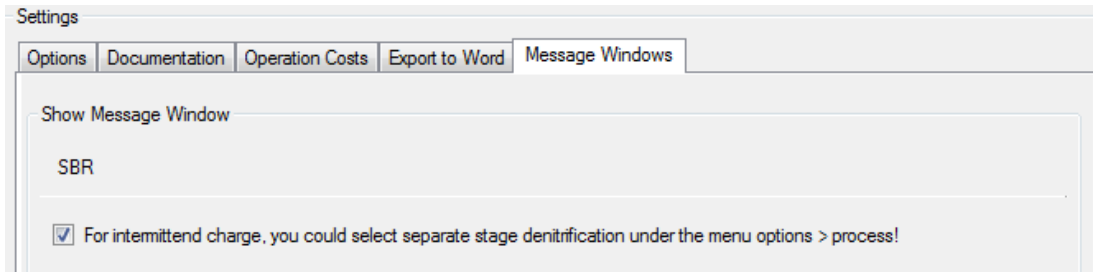

Fig. 174: Options > Settings > Message Windows

## 15.3 Process

Before starting the calculation you have to select the basis of calculation, the cleaning process and the kind of aeration. The possible variants are concluded in this form.

### 15.3.1 Nutrient Elimination

Before you start a calculation, the standard and the elimination process has to be chosen. The available variants are at Options – Process.

Nitrogen Elimination

only Carbon Degradation

only Nitrification

intermittend

Separate Stage

Simultaneous

combined

Basis of Design A 131

Separate Stage Anaerobic Mix Tank

Separate Stage Aerobic Selector

COD

Aeration

Membrane Aerator

Surface Aerators

Guideline

DWA  MSIG

IDEA

OK Cancel

Fig. 175: Options > Process

### 15.3.2 Basis of Design A 131

Design with COD, the anaerobic chamber and the aerobic selector are only available for the DWA-A 131, 2016.

The selector helps to prevent bulking sludge.

Ein Selektor wurde eingeführt, um Blähschlamm Bildung zu vermeiden.

### 15.3.3 Aeration

Information for variants of the aeration are in Chapter Dimensioning in Aeration.

### 15.3.4 Standards

Beside the DWA standards some parts of Metcalf & Eddy and MSIG is already implemented. That concerns load and some process steps.

For SBR processes there is further to the standard SBR process a process with continuous inflow and intermittend clear water decantation. If the SBR process with continuous inflow is chosen, the line for SBR is adapted accordingly.

A headline IDEA (Intermittend Decant Extended Aeration) appears.

## 15.4 General Constants

### 15.4.1 Generell

Fig. 176: Options > General Constants

### Temperature

When calculating the sludge load, the temperature is taken into account based on a selected sludge age and in accordance with the ATV A 131 /39/. For climate conditions very different from those in western Europe it is necessary to change the temperature. For example an average temperature of 20 or 25 °C should be selected for (most) african countries.

### Peak Factors

The DWA standard is not used everywhere without restriction. Especially für the aeration there are different methods. By the peak factors for carbon and nutrient the design can be adapted to other methods.

### Oxygen Content

The concentration of oxygen during operaton should be selected depending on the process.



BITControl	AQUA DESIGNER 9.2 - Manual	Seite: <b>287</b> von 314
	15 Menu Options	Version: <b>92-00</b>

### **Load Variation, Case Study**

The aeration is designed for the most unfavorable case, based on the leaflet DWA-M 229-1. 4 cases are recommended there. A minimum, average and maximum case and a prognosis. Valid for the design is case 2.

The set temperature is taken in the aeration form.

### **Case Study Temperature**

When designing the activated sludge basin according to A131, the temperature is included in the calculation of the specific excess sludge production and thus the sludge load. It makes sense to change the design temperature if you are working out a plan or an offer for a region with different climatic conditions. In many African countries it makes sense to calculate with a temperature of 20 or 25°C.

### **Specific Excess Sludge Production**

The excess sludge production is depending on the water temperature. So for deviating temperature it is useful to change the temperature here.

### **Maximum Sludge Volume Loading**

The recommended values of the DWA are preselected. Here you are able to change the value for horizontal and vertical flow clarifiers.

### **SBR**

SBR plants are usually fed by batches. Then at the beginning you will have a higher oxygen demand. This can be considered by the factor for increased oxygen demand at the beginning.

### **Yield COD**

The Yield is not the same for all of the standards or kinds of wastewater. So here you can adapt it to your conditions.

## **15.4.2 Load**

Also the load is different for different regions. This depends for example on the amount of wasted food which gets into the sewer.

Spec. Name	Code	Value	Unit
Spec. Municipal Wastewater Flow		125,00	l/(P*d)
Infiltration quantity		50,00	%
Spec. BOD5-Charge	b.dsb5	60,00	g/(P*d)
Spec. COD-Charge	b.dcsb	120,00	g/(P*d)
Spec. MLSS-Charge	b.dts	70,00	g/(P*d)
Spec. TKN - Charge	b.dkn	11,00	g/(P*d)
Spec. P-Charge	b.dp	1,80	g/(P*d)
Spec. NO3-N-Load	b.dno3	0,00	g/(P*d)

Radio button options:  DWA,  MSIG,  M&E,  Custom

Buttons: Reset, Save as standard, OK, Cancel

Fig. 177: Options &gt; General Constants &gt; Load

## 15.4.3 Nitrogen Balance

### N-Incorporation in the biomass

The preselected value for the fraction of microorganisms nitrogen incorporation is a recommended value from the ATV guideline. For special or extraordinary compositions and differing ratios of the BOD5 and nutrients in the wastewater, it is necessary to determine the composition and select suitable values in the program.

Parameter	Value	Unit
Part of Ammonia in the TKN	50	%
N-Incorporation in the Biomass	0,040	kgN/kgBOD5
Organic-N in the Outflow	2,00	mg/l
Oxygen Concentration in the Outflow of the Activated Sludge Chamber	3,00	mg/l

Fig. 178: Options &gt; Process: Nitrogen Balance

## 15.4.4 Sludge Treatment

General	Load	Nitrogen Balance	Sludge Treatment	Buildings / Equipment	Precipitant
Sludge Treatment					
SS-Waste Sludge (Output)			1,0 %		
SS-Primary Sludge (Output)			2,5 %		
SS-Thickening			5,0 %		
SS-Sludge Tank			5,0 %		
SS Dewatering			32,0 %		
SS-Sludge Disposal			32,0 %		

Fig. 179: Options &gt; Generell Constants: Sludge Treatment

The MLSS of several sludge treatment steps are based on experience. In AQUA DESIGNER everytime you get recommended values, based on literature. The dry solids concentration depends on the kind of thickening or dewatering process. For example in a filter belt you get a different concentration than in a filter press or a decanter.

Therefore it is able to edit these values and to enter your own MLSS concentration for each step.

The chosen dry solids concentrations also have influence on the supernatant amount.

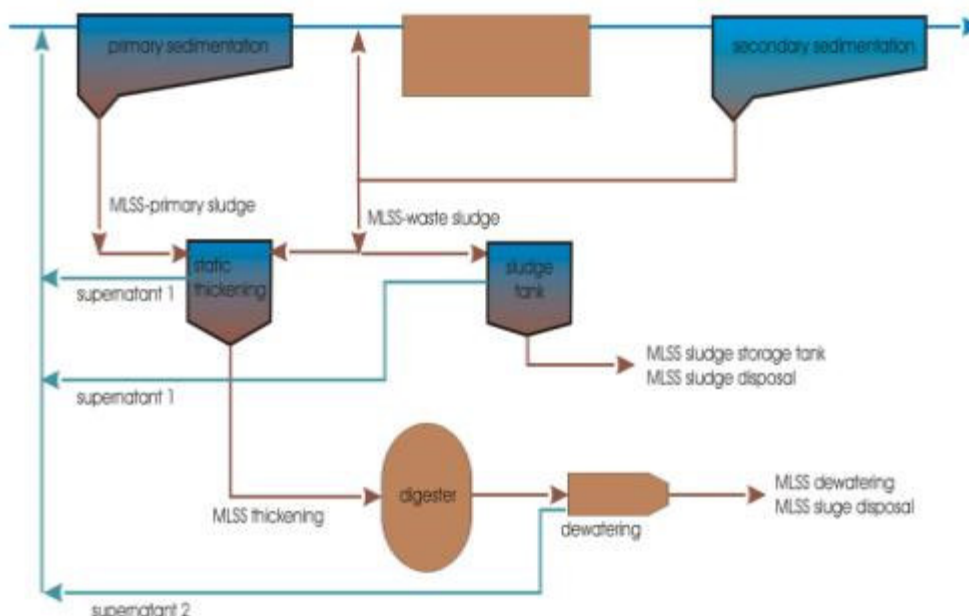

Fig. 180: Steps of Sludge Treatment

### 15.4.5 Buildings / Equipment

Choose **Options > Generell Constants > Building / Equipment**. Enter your data

for building, machines, aeration and flow velocity.

The screenshot shows the 'Buildings / Equipment' tab with the following data:

Section	Parameter	Value	Unit
Data of the Building	Inner Sedimentation Tank		
	Difference of Water Levels	10,0	cm
	Inner Sedimentation Tank		
	Wall Thickness Sedimentat. Tank	30,0	cm
Secondary Settling Tank	Base slope (round Tank)	3,8	°
	Base Slope (rectangular Tank)	3,8	°
	Lower Diameter of Cone	40,0	cm
Machines	Blower mechanical Losses (%)	5,0	
Aeration	Aeration Depth over Base	30	cm
	Loss of pressure in the Pipes	150	mbar
Flow Velocities	Water	1,0	m/s
	Air	12,0	m/s

Fig. 181: Options > Generell Constants: Buildings / Equipment

## 15.4.6 Precipitant

Click on **Options > Generell Constants > Precipitant**.

Here you can enter new precipitants and choose other parameters for the external C-Dosage. On the left site you could vary some parameters of iron and aluminium salt.

The screenshot shows the 'Precipitant' tab with the following data:

Section	Parameter	Value	Unit
Dosing Chemical External C-Dosage	Methanol		
	Density	790	kg/m <sup>3</sup>
	COD-Concentration	1185	kg/m <sup>3</sup>
	Denitrification Capacity	0,30	kgN/kgCSB
	Denitrification Rate	2,5	g/(kg*h)
	Additional ES-Production	0,50	kg/kgCSB
	Buttons	Remove Chemical, Add Dosing Chemical, Save	
DWA/ATV Settings	<input type="checkbox"/> Dosage Volume acc. to DWA (0,2 kgN/kgCSB)		
	<input checked="" type="checkbox"/> Additional ES-Production acc. to DWA (ATV) (0,5 kg/kgCSB)		
	<input checked="" type="checkbox"/> Organic Part of MLSS acc. to ATV-M368		
Organic Part of MLSS	0,70		
Input Dosage Medium	<input type="radio"/> Dosage before Activated Chamber		
	<input checked="" type="radio"/> Dosage after Activated Chamber		
	<input type="radio"/> Dosage in Return Sludge		
Density Precipitant	Iron Salt FeCl3		
	Dichte	1,50	kg/l
	Konzentration	40,0	%
	Aluminium Salt AlCl3		
	Dichte	1,50	kg/l
	Konzentration	40,0	%
Iron Salt FeSO4			
Dichte	1,23	kg/l	
Konzentration	45,0	%	
Buttons	Reset, Save as standard, OK, Cancel		

Fig. 182: Options > Generell Constants: Precipitant

## 15.5 Constants COD

Click on **Options > Constants COD**. In the formular you set the arguments for the Chemical oxygen demand COD.

Part of Particular COD of the Organic Dry Substance	1,20	gCOD/gOrganic Dry Solid
Constant for Dimensioning of the Inflow Concentration of the separate COD fractions:		
Inert Part of the particular COD relating to the total particular COD	0,25	
Inert Part of the dissolved COD relating to the total COD	0,05	
Anorganic Part of the Particular COD (without Primary Clarification)	0,30	
Anorganic Part of the Particular COD (with Primary Clarification)	0,20	
Degree of Yield	0,67	
Decomposition Coefficient	0,17	1/d
Inert Part of the COD of the Biological Degradation	0,20	

Fig. 183: Options > Constants COD

## 15.6 Constants Hochschulgruppe

Choose **Options > Constants Hochschulgruppe**. In this formular you can vary a lot of parameters, like kinetic, stöchiometric or oscillation factors.

Kinetic Factors			Stoichiometric Factors		
Maximum Growth Rate	nmax	0,52 1/d	Part of Inert Rests of Died Bacteria	fp	0,6
Reaction Constant for nmax	Kn	0,7 mgN/l	Part of N in the Biomass	B	0,12
Die Rate of Nitrificants	bA	0,05 1/d	Part of N in the Inert Materia	li	0,01
Die-Off Rate of heterotrophic Bacteria	bH	0,17 1/d	Inert Part of Biological Degradation	fi	0,2
Temperature Factor for the growth of Nitrificants	fT,A	1,103	Part of P in the Biomass	ip	0,03
Temperature Factor for the Die-off-Rate of Nitrificants	fT,bA	1,09	BOD5-Efficiency in the Activated Chamber	eta	0,95
Temperature Factor for growth and die-off of the heterotrophic bacteria	fT,bH	1,073	Oscillation Factor		
Yield of Nitrificants	YA	0,15	Security Factor	f'	1,25
Yield of heterotrophic Biomass	YH	0,75	Substrate Oxidation	fOV,s	0,56
Reduction of O2-Depletion in the Anoxic Zone	fd	0,75	Rate of endogenous Metabolism	fOV,e	0,2
			<input type="button" value="Standard Values"/> <input type="button" value="OK"/> <input type="button" value="Cancel"/>		

Fig. 184: Options > Constants Hochschulgruppe

## 15.7 Details

### Shock Factors for Oxygen Supply

The ATV guideline is not universally accepted and employed in all its details in German countries. This particularly affects the dimensioning of aeration systems. The program can adapt to different values for carbon dioxide and nitrogen respiration. However, the ATV values offer a safe alternative for dimensioning the oxygen supply.

### Immersion Depth

The difference between water depth and immersion depth depends on the construction of the aeration system. A distance of 30 cm is applicable for most of the systems. You may enter another value for other construction plans. For example, in case of pressure loss at a limit for blowers you may enter a lower difference to increase the immersion depth.

(Changing the immersion depth makes it possible to achieve a lower or higher pressure for the blowers.)

### Pressure Losses in the Air Pipes

The pressure loss in the air pipes are automatically added to the immersion depth for dimensioning of the blowers. This pressure loss depends on the total length of the pipes, the pipe layout, and to a large extent on the selected aeration equipment and aerator load. The preselected value has been proven to be sufficient in practice. However, you can change this factor when you are sure about a lower pressure loss of your system and thus, the system will work more economically lowering operating costs.

### SS<sub>RS</sub> / SS<sub>BS</sub>

The ratio of the mixed liquor suspended solids concentration at the bottom of the sedimentation tank and in the return sludge is dependent on the selected sludge removal system.

A ratio of 0.5 is suggested for a suction remover. A value of 0.7 should ideally be selected for a sludge scraper. The ratio will automatically be selected as 1 for the hopper-bottomed secondary sedimentation tank as there is no special removal system required.

### Water Level Difference

The water level difference of the activated chamber and the sedimentation chamber results from a hydraulic calculation. The hydraulic calculation is not yet part of AQUA DESIGNER. An average value 10 – 30 cm is suggested. The lower value is

BITControl	AQUA DESIGNER 9.2 - Manual	Seite: <b>293</b> von 314
	15 Menu Options	Version: <b>92-00</b>

in effect for compact systems, the higher value for separate chambers.

### Sedimentation Tank Wall Thickness

For a compact system, the thickness of the sedimentation tank wall is taken into account when calculating the activated sludge tank outer diameter and volume.

It is not possible to change this value in the form **drawings**. For changing the wall thickness value, it is necessary to recalculate the activated chamber starting from the sedimentation tank step.

### Bottom Slope / Circular Chambers

For the bottom slope of the sedimentation chamber the commonly applied value of 1/15 or 3.8° is preselected.

Enter a slope of 0° when using a suction remover and remember then to change the MLSS ratio. This is not automatically done by the program as the factor of 0.5 is not explicitly required.

### Bottom Slope / Rectangular Chambers

A lower angle for the slope can be selected for a rectangular chamber. In AQUA DESIGNER, like the value for circular chambers, the default value is set as 1/15 or 3,8°.

### Cone Base Diameter

A cone is present in several constructions for sedimentation tanks. For compact chambers the basic diameter is the diameter at the bottom of the tank. This value will be taken into account for calculating the hopper-bottom tank water depth.

For sedimentation tanks with flat bottoms, the basic diameter is the diameter at the bottom of the sludge collecting cone.

### Flow Velocities

The diameter of air and water pipelines is calculated using the flow velocity of water and air. For more information see the chapter **Extras > Pipelines**.

## 16 Formularic Symbols

German	English	Unit	Description
a	A		Respiration growth factor
ADüker	Asyphon	m <sup>2</sup>	Surface of the inlet in sedimentation chambers
ANB	A <sub>ST</sub>	m <sup>2</sup>	Surface of the Sedimentation Chamber
Al	Al	mg/l	Precipitant amount in Aluminium
$\alpha$ OC	$\alpha$		Quotient of oxygen transfer in activated sludge and in clean water
B	B		Part of nutrient in biomass (xH+xA), Hochschulansatz
bA	bA	d <sup>-1</sup>	die rates of autotrophic organism, Hochschulansatz
bH	bH	d <sup>-1</sup>	Die rates of heterotrophic organism, Hochschulansatz
BB	AT		Activated Chamber/ Aeration Tank
BBelüfter	BAerator	m <sup>3</sup> /(m <sup>3</sup> *h)	Load of the Aerators
Bd,BSB5	Bd,BOD5 F/M*	kg/d	BOD <sub>5</sub> -Charge
BR	BR,BOD5	kg/(m <sup>3</sup> *d)	BOD <sub>5</sub> -volume loading
BSB5	BOD5	mg/l	Biological oxygen demand in 5 days
BSB5zu	BOD5i	mg/l	Inflow concentration to the activated chamber
BTS	BSS,BOD	kg/(kg*d)	BOD <sub>5</sub> -sludge loading
C	C	l/m <sup>3</sup>	Sludge concentration depending on the thickening time in the sedimentation chamber
C <sub>i/g</sub>	C <sub>i/g</sub>	mg/l	Concentration of industriell or trade waste water components
cp	Cp	kJ/(kg*K)	specific heat capacity
Cs	Cs	mg/l	Dissolved oxygen saturation concentration dependent on the temperature and partial pressure
Cs,theor	Cs,theor	mg/l	Oxygen Saturation Concentration at an average temperature
CSB	COD	mg/l	Chemical oxygen demand
Cx	Cx	mg/l	Desired dissolved oxygen concentration in aeration tanks (DO)
DBB	DAT	m	Outer free diameter of the activated chamber
DBBSohle	D <sub>AT,Bottom</sub>	m	Diameter of the sedimentation chamber at the bottom of the activated chamber (compact plant)
DDüker	Dsyphon	m	Diameter of the inlet fo sedimentation chambers
DNB	D <sub>ST</sub>	m	Diameter of the sedimentation chamber
Dspitze	D <sub>bottom</sub>	m	Diameter of hopper tanks at the bottom
dT	dT	K	Increasment of temperature
DTrichter	D <sub>hopper</sub>	m	Diameter of the sludge collecting cone in horicontal flooded sedimentation chambers



German	English	Unit	Description
E	I	I	Inhabitants
$\varepsilon$	$\varepsilon$		Part of heat emission of the motor power
E	E	kWh/a	Yearly energy demand for wastewater transport
Eh	Eh	kWh/h	Hourly energy demand for wastewater transport
EW	PT	-	Total number of inhabitants and population equivalents referred to the parameters BOD <sub>5</sub> or COD
fA	fA		Volume exchange ratio
fA,max	fA,max		Maximum volume exchange ratio
fA,vor	fA,vor		Proposed volume exchange ratio
fA,TW	fA,TW		Volume exchange ratio at dry weather
fC	fC	-	Peak factor for carbon respiration
fN	fN	-	Peak factor for ammonium respiration
fO <sub>2</sub>	fO <sub>2</sub>	gO <sub>2</sub> /(m <sup>3</sup> *m)	Oxygen transfer capacity
Fe	Fe	mg/l	Precipitant amount in Fe
FS	FS	m	Flow distance in the sedimentation chamber
ftbh	ftbh	-	Conversion factor for temperature influent
G	G	m/s <sup>2</sup>	Gravitation factor
Ga	Ga	Dollar/a	Yearly salary for one person
f'	F'		Safety factor
FD	FD		Decreasing of respiration at anoxic conditions
Fi	Fi		Inert part out of biomass degradation
fT,A	fT,A		Temperature factor for autotrophic growth
fT,bA	fT,bA		Temperature factor for the autotrophic die rate
fT,bH	fT,bH		Temperature factor for the heterotrophic die
Fp	Fp		Part of inert solids
$\eta$	$\eta$		Yield of BOD-degradation
H	H	M	Manometric transportation height (pumping head)
h1	h1	M	Height of the clear water zone in the sedimentation chamber
h2	h2	M	Height of the dividing zone in the sedimentation chamber
h3	h3	m	Height of the storage zone in the sedimentation chamber
h4	h4	m	Height of the thickening zone in the sedimentation chamber
HBB	HAT	m	Water depth of the activated Chamber
he	He	m	Infiltration height of the inlet
hE	HE	m	Immersion depth of air
hges	hges	m	Water depth in the sedimentation chamber
HKegel	HCone	m	Difference between the peripheral water depth and the depth at the sludge collecting cone in the

German	English	Unit	Description
			sedimentation chamber
HMitte	H <sub>middle</sub>	m	Water depth at the sludge collecting cone in the sedimentation chamber
hmittel	h <sub>average</sub>	h/d	Hour index
h <sub>NB</sub>	h <sub>ST</sub>	m	Water depth in the sedimentation chamber
H <sub>NBRand</sub>	H <sub>NBper</sub>	m	Peripheral water depth in the sedimentation chamber
h <sub>s</sub>	h <sub>s</sub>		Sludge level
h <sub>t</sub>	H <sub>t</sub>	m	Cone height of a hopper tank
h <sub>w</sub>	H <sub>w</sub>	m	Water level
h <sub>z</sub>	H <sub>z</sub>	m	Cylindrical height of a hopper tank
ISV	ISV	ml/g	Sludge volume index
i <sub>B</sub>	I <sub>B</sub>		Part of Nutrient in the Biomass
il	il		Part of Nutrient in the inert mass
ip	ip		Part of phosphate in the biomas
kLa	kLa	-	Aeration factor at temperature T
KN	KN		Half-life constant for N <sub>max</sub>
L <sub>Belüfter</sub>	L <sub>Aerator</sub>	m	Aerator length
M <sub>Al</sub>	M <sub>Al</sub>	g/mol	Atom mass Aluminium
M <sub>Fe</sub>	M <sub>Fe</sub>	g/mol	Atom mass Iron
M <sub>P</sub>	M <sub>P</sub>	g/mol	Atom mass Phosphorus
m <sub>z</sub>	m <sub>z</sub>		Number of cycles
n	N		Rainwater factor
N <sub>ab</sub>	N <sub>e</sub>	kg/d	Nutrient in the effluent
NB	NB		Sedimentation Chamber
N <sub>bio</sub>	N <sub>bio</sub>	mg/l	Inkorporated nutrient
N <sub>d,m1</sub>	e		denitrificable nutrient
N <sub>d,m2</sub>			Nutrient to be denitrificated
Neigung	Slope		Slope of the bottom at horizontal floaded sedimentation tanks
nG	nG		Number of blowers
	N <sub>Deni</sub>	kg/d	Denitrificated nutrient
NH <sub>4</sub> -Ne,Sp	NH <sub>4</sub> -Ne,Sp	mg/l	Peak ammonia outlet nitrification
NH <sub>4</sub> -Ne,m	NH <sub>4</sub> -Ne,m	mg/l	Middle ammonia outlet concentration
Nn,Sp	Nn,Sp	mg/l	Nitrificable peak ammonia inlet
Nn,m	Nn,m	mg/l	Averabge nitrificable ammonia inlet
N <sub>anorg</sub>	N <sub>inorg</sub>	mg/l	Anorganic nutrient concentration outlet
N <sub>org</sub>	N <sub>org</sub>	mg/l	Organic nutrient concentration outlet
NO <sub>3</sub> -N	NO <sub>3</sub> -N	mg/l	Nitrate-N
NO <sub>3</sub> -ND	NO <sub>3</sub> -ND	mg/l	Denitrificated Nitrate-N-Concentration
NO <sub>3</sub> -Ne	NO <sub>3</sub> -Ne	mg/l	Nitrate-N in the effluent

German	English	Unit	Description
	$N_{\text{Nitri}}$	kg/d	Nitrificated nutrient
$n_R$	$n_R$		Rain frequency
$N_{\text{ÜS}}$	$N_{\text{WS}}$		Nutrient in waste sludge
$N_{\text{Zu}}$	$N_{\text{Zu}}$	mg/l	Nutrient-N-Concentration in the inflow
$n_{\text{max,A}}$	$n_{\text{max,A}}$		Maximum growth rate,
OB	OB	kg/kg	Oxygen charge
$OB_{\text{mittel}}$	$OB_{\text{average}}$	kg/kg	Oxygen charge without stress factors
OC	OC		Oxygen transfer capacity
OCA	OCA		Minimum oxygen input for surface aeration
OP	OP		Oxygen efficiency
OV	OV		Oxygen consumption
OVC	OVC	kg/kg	Specific oxygen demand for BOD <sub>5</sub> -degradation
OVN	OVN	kg/kg	Specific oxygen demand for the oxidation of nutrient, related to BOD <sub>5</sub>
Po	Po		Phosphate concentration inlet
Pe	Pe		Phosphate concentration outlet
P	P	mg/l	Orthophosphate concentration
Pa	Pa	DM/a	Yearly staff costs
$P_{\text{elim}}$	$P_{\text{elim}}$	kg/d	Phosphate for removal
Pn	Pn	-	Number of persons
qA	qA	m/h	Surface loading
Qf	Qf	m <sup>3</sup> /h	Inflow of extraneous water per hour
Qfd	Qfd	m <sup>3</sup> /d	Inflow of extraneous water per day
Qg	Qg	m <sup>3</sup> /h	Inflow of trade wastewater per hour
Qgd	Qgd	m <sup>3</sup> /d	Inflow of trade wastewater per day
Qh	Qh	m <sup>3</sup> /h	Inflow of domestic wastewater per hour
Qi	Qi	m <sup>3</sup> /h	Inflow of industriell wastewater per hour
Qid	Qid	m <sup>3</sup> /d	Inflow of industriell wastewater per day
QL	QL	m <sup>3</sup> /h	Air volume flow per hour
$QL_{\text{Gebläse}}$	$QL_{\text{Blower}}$	m <sup>3</sup> /h	Capacity of a blower
$QL_{\text{Betrieb}}$	$QL_{\text{Betrieb}}$	m <sup>3</sup> /d	Daily air demand in operation
Qm	Qm	m <sup>3</sup> /h	Stormwater inflow
$Q_{\text{mittel}}$	$Q_{\text{average}}$	m <sup>3</sup> /h	Average hourly inflow
$Q_R$	$Q_{RS}$ $Q_{r^*}$	m <sup>3</sup> /h	Return sludge flow
Qs	Qs	m <sup>3</sup> /h	Inflow of wastewater per hour
Qsd	Qsd	m <sup>3</sup> /d	Inflow of wastewater per day
qsv	qsv	l/(m <sup>2</sup> *h)	Sludge volume loading
$Q_{Sp}$	$Q_{Sp}$		Inflow according to nitrificabel nutrient concentration
$Q_{24}$	$Q_{24}$		24-hours average
Qt	Qt	m <sup>3</sup> /h	Inflow at dry weather per hour

German	English	Unit	Description
Qtd	Qtd	m <sup>3</sup> /d	Inflow at dry weather per day
Qzu	Qzu	m <sup>3</sup> /d	Inflow of Wastewater per day
$\rho$	$\rho$	kg/m <sup>3</sup>	Density
$\rho_L$	$\rho_L$	kg/m <sup>3</sup>	Density of air
RS	RS	-	Return Sludge
RV	RV	-	Return sludge relation
RZ	RZ	-	Recirculation ratio
RZges	RZges	-	Recirculation ratio including return sludge
rx	rx	-	Part of returned nutrient out of waste sludge
$\beta$	$\beta$	-	Molar relations for precipitants in the phosphate elimination
S	T	°C	Wastewater temperature
So'	td	h/d	Daily working time of 1 person
S <sub>Ke</sub>	S <sub>Ke</sub>		Alkalinity outlet
S <sub>Ko</sub>	S <sub>Ko</sub>		Alkalinity inlet
T	T		Temperature
t <sub>d</sub>	t <sub>d</sub>		Daily working time
t <sub>E</sub>	t <sub>E</sub>	h	Thickening time for TS <sub>BS</sub> (MLSS) at the Bottom of the sedimentation tank
TKN	TKN	mg/l	Kjeldahl-nutrient-concentration (Ammonia-N and organic N)
tL	tL	h/d	Operation time of the blowers
tLdim	tLdim	h/d	Aeration time out of the dimensioning
t <sub>s</sub>	t <sub>s</sub>	h	Storage time
TS <sub>BB</sub>	TS <sub>BB</sub> MLSS*	kg/m <sup>3</sup>	Mixed liquor suspended solids in the activated chamber
TS <sub>BS</sub>	TS <sub>BS</sub>	kg/m <sup>3</sup>	Concentration of TS (MLSS) at the bottom of the sedimentation tank
TS <sub>o</sub>	TS <sub>o</sub>	mg/l	TS in the inflow of the activated chamber
TS <sub>R</sub>	TS <sub>R</sub>	kg/m <sup>3</sup>	TS in the reactor (here the activated chamber)
TS <sub>RS</sub>	TS <sub>RS</sub> XR*	kg/m <sup>3</sup>	Solids concentration in the return line
T <sub>SR,TW</sub>	T <sub>SR,TW</sub>		
t <sub>TS</sub>	t <sub>TS</sub> $\theta_c^*$	d	Sludge age, cell residence time
t <sub>TS,A</sub>	t <sub>TS,A</sub>		Aerobic sludge age
t <sub>TS,G</sub>	t <sub>TS,G</sub>		Total sludge age
t <sub>z</sub>	t <sub>z</sub>		Time of cycle
t <sub>R</sub>	t <sub>R</sub>	h	Time of reaction
t <sub>D</sub>	t <sub>D</sub>	h	Time of denitrification
t <sub>N</sub>	t <sub>N</sub>	h	Time of nitrification

German	English	Unit	Description
$\Theta_H$	$\Theta_H$		Hydraulical retention time in an activated sludge system
ÜS	WS Px*		Excess sludge * /17/ Hochschulansatz
ÜSB	WS <sub>B</sub>	kg/kg	Specific excess sludge production related to BOD5
ÜS <sub>BSB5</sub>	WS <sub>BOD5</sub>	kg/kg	Part of the biological excess sludge production
ÜSp	WSp	kg/kg	Part of the chemical excess sludge production
V1	V1	m <sup>3</sup>	Volume of the clearwater zone
V2	V2	m <sup>3</sup>	Volume of the dividing zone
V3	V3	m <sup>3</sup>	Volume of the storage zone
V4	V4	m <sup>3</sup>	Volume of the thickening zone
V <sub>BB</sub>	V <sub>BB</sub>	m <sup>3</sup>	Volume of the activated chamber
V <sub>D</sub>	V <sub>D</sub>	m <sup>3</sup>	Denitrification volume
V <sub>N</sub>	V <sub>N</sub>	m <sup>3</sup>	Nitrification volume
V <sub>R</sub>	V <sub>R</sub>	m <sup>3</sup>	Volume of the reactor
V <sub>R,TW</sub>	V <sub>R,TW</sub>	m <sup>3</sup>	Volume at dry weather
V <sub>min</sub>	V <sub>BBmin</sub>	m <sup>3</sup>	Minimum volume of the activated chamber
$\Delta V$	$\Delta V$		Exchange volume
$\Delta V_{TW}$	$\Delta V_{TW}$		Exchange volume at dry weather
V <sub>SV</sub>	V <sub>SV</sub>		Sludge volume (by the dilution method)
vs	vs	m/s	Settling velocity
V <sub>U</sub>	V <sub>U</sub>	m <sup>3</sup>	Volume of the sedimentation chamber under the bottom of the activated chamber at compact plants
V <sub>ÜS</sub>	V <sub>WS</sub>		Volume of waste sludge
	ws		Water usage from A 226, A131
	x	h/d	hour index from A118
x <sub>A</sub>	x <sub>A</sub>		Part of autotrophic organism in activated sludge
x <sub>H</sub>	x <sub>H</sub>		Part of heterotrophic organism in activated sludge
x <sub>I</sub>	x <sub>I</sub>		Inert part in activated sludge
x <sub>F</sub>	x <sub>F</sub>		Precipitation sludge in activated sludge
Y <sub>H</sub>	Y <sub>H</sub>		Yield of heterotrophic biomass
Y <sub>A</sub>	Y <sub>A</sub>		Yield of autotrophic biomass

## 17 Literature

- /1/ Härtel, Lutz (1990):  
Modellansätze zur dynamischen Simulation des Belebtschlammverfahrens  
WAR Schriftenreihe, Darmstadt, Nr. 47
- /2/ ATV Arbeitsblatt A 131, (1991):  
Bemessung von einstufigen Belebungsanlagen ab 5000 Einwohnerwerten  
Gesellschaft zur Förderung der Abwassertechnik e.V.  
(GfA), Hennef
- /3/ ATV Arbeitsblatt A 126, (1993):  
Grundsätze für die Abwasserbehandlung in Kläranlagen nach dem Belebungsverfahren mit gemeinsamer Schlammstabilisierung bei Anschlußwerten zwischen 500 und 5000 Einwohnerwerten  
Gesellschaft zur Förderung der Abwassertechnik e.V.  
(GfA), Hennef
- /4/ ATV Arbeitsblatt A 202, (1992):  
Verfahren zur Elimination von Phosphor aus Abwasser  
Gesellschaft zur Förderung der Abwassertechnik e.V.  
(GfA), Hennef
- /5/ Boll, Dr. Ing. R.:  
Kläranlagen ab 5000 EW (A 131, AB 2.5/2.6, 2/93)  
ATV-Regelwerkkurs Abwasserreinigung 27. - 29.11.95 in Weimar
- /6/ ATV Arbeitsblatt A 203, (1995):  
Abwasserfiltration durch Raumfilter nach biologischer Reinigung  
(GfA), Hennef
- /7/ ATV-Arbeitsberichte:  
Anwendungshinweise zum ATV Arbeitsblatt A 131-Teil Nachklärbecken  
Korrespondenz Abwasser 2/93
- /8/ Arbeitsbericht des ATV-Fachausschusses 2.12 „Betrieb von Kläranlagen“  
Personalbedarf für den Betrieb von Kläranlagen  
Korrespondenz Abwasser, 6/94
- /9/ Heinz Patt, Andreas Stein:  
Einsatz belüfteter Sandfänge auf Kläranlagen  
Korrespondenz Abwasser 9/96
- /10/ Norbert Meyer:  
Biologische Phosphatelimination und simultane Denitrifikation  
Abwassertechnik 4/94, Bauverlag GmbH, Wiesbaden
- /11/ von der Emde, Univ.-Prof. Dr.-Ing Wilhelm:  
Achtzig Jahre Belebungsverfahren  
KA-Betriebs-Info, Hennef, 4/95
- /12/ Rheinheimer G., Hebemann W., Raff J. Sekoulov I.:  
Stickstoffkreislauf im Wasser  
R. Oldenbourg-Verlag, München-Wien, 1988

BITControl	AQUA DESIGNER 9.2 - Manual	Seite: <b>301</b> von 314
	17 Literature	Version: <b>92-00</b>

- /13/ Lehr- und Handbuch der Abwassertechnik:  
Band IV, Biologisch-chemische und weitergehende Abwasserreinigung  
Abwassertechnische Vereinigung e.V., Bad Hennef  
Ernst & Sohn, Berlin, 1985
- /14/ Arbeitsbericht des ATV-Fachausschusses 2.5 „Absetzverfahren“:  
Bemessung und Gestaltung getauchter, gelochter Ablaufrohre in Nachklär-  
becken  
Korrespondenz Abwasser 2/1997
- /15/ Pöpel, H.J., Wagner, M.,  
Grundlagen von Belüftung und Sauerstoffeintrag  
WAR-Schriftenreihe, TH Darmstadt, Band 37 (1989)
- /16/ VDI-Wärmeatlas  
Berechnungsblätter für den Wärmeübergang  
VDI-Verlag GmbH, Düsseldorf, (1984)
- /17/ Metcalf & Eddy  
Wastewater Engineering, Treatment Resposal Reuse  
McGraw Hill, Third Edition, (1991)
- /18/ R. Boll  
Verfahrenstechnische Grundlagen der biologischen Phosphorelimination  
in Biologische und Chemische Phosphatelimination  
WAR Schriftenreihe Nr. 51, Verein zur Förderung des Instituts für Wasser-  
versorgung, Abwasserbeseitigung und Raumplanung der Technischen  
Hochschule Darmstadt, (1991)
- /19/ Böhnke et al.,  
Bemessung der Stickstoffelimination in der Abwasserreinigung (HSG-  
Ansatz);  
Korrespondenz Abwasser, H. 9/89, S. 1046 - 1061
- /20/ Abeling, U., Härtel, L., Hartwig, P., Nowak, O., Otterpohl, R., Schwentner,  
G., Svardal, K., Wolffson, C.,  
Bemessung von Kläranlagen zur Stickstoffelimination, Vergleich ATV-A 131  
- HSG,  
Korrespondenz Abwasser, H. 2/1991, S. 222 - 227
- /21/ Dohmann et al.,  
Bemessung der Belebungsbecken nach dem Ansatz der Hochschulgruppe  
(HSG-Ansatz); Korrespondenz Abwasser, H. 8/1993, S. 1240
- /22/ Böhnke, B.; Pinnekamp J.  
Nitrifikation und Denitrifikation in ein- und zweistufigen Belebungsanlagen  
KA, 5/89
- /23/ Merkblatt ATV - M 209  
Messung der Sauerstoffzufuhr von Belüftungseinrichtungen in Belebungsan-  
lagen in Reinwasser und in belebtem Schlamm  
Abwassertechnische Vereinigung e.V., Juni 1996
- /24/ Merkblatt ATV - M 210  
Belebungsanlagen mit Aufstaubetrieb

- Abwassertechnische Vereinigung e.V., September 1997
- /25/ Konrad Stania, Manfred Lehner, Raimund Haberl  
Denitrifikation in intermittierend betriebenen Belebungsanlagen (SBR)  
Korrespondenz Abwasser, 1/97, S. 61 - 65
- /26/ 4. Abwasser-Tagung  
SBR-Technik - Anlagenbauer und Planer berichten über ihre Erfahrungen in  
Deutschland  
Verband Deutscher Maschinen- und Anlagenbauer e.V., 11/97
- /27/ Bever, Stein, Teichmann  
Weitergehende Abwasserreinigung  
Oldenbourg-Verlag, 2.Auflage
- /28/ Dr.-Ing. Martin Wagner  
Sauerstoffeintrag und Sauerstofftrag von Belüftungssystemen und  
deren Bestimmung mit modernen Messmethoden  
Schriftenreihe WAR des Instituts WAR der TU Darmstadt, Darmstadt 1997
- /29/ H.J. Pöpel  
Grundlagen der chemischen Phosphorelimination  
WAR Schriftenreihe Nr. 51, Verein zur Förderung des Instituts für Wasser-  
versorgung, Abwasserbeseitigung und Raumplanung der Technischen  
Hochschule Darmstadt, (1991)
- /30/ Arbeitsbericht der ATV-Arbeitsgruppe 2.6.6 "Biologische Phosphorentfer-  
nung"  
Korrespondenz Abwasser 3/89
- /31/ Arbeitsbericht der ATV-Arbeitsgruppe 2.6.1 Blähschlamm, Schwimm-  
schlamm und Schaum in Belebungsanlagen – Ursachen und Bekämpfung  
Korrespondenz Abwasser 10/98
- /32/ ATV-Handbuch  
Mechanische Abwassereinigung  
Abwassertechnische Vereinigung e.V., Bad Hennef  
Ernst & Sohn, Berlin, 1996
- /33/ M. Boes,  
Anordnung und Bemessung der Luftzufuhr von belüfteten Sandfängen  
Korrespondenz Abwasser 7/90
- /34/ A. Stein  
Ein Beitrag zur Gestaltung belüfteter Sandfänge  
Korrespondenz Abwasser 4/92
- /35/ J. Londong  
Beitrag zur Bemessung belüfteter Sandfänge  
Korrespondenz Abwasser 1/88
- /36/ ATV-Arbeitsbericht der ATV-Arbeitsgruppe 2.5.1 "Sandfänge"  
im ATV-Fachausschuß 2.5 Absetzverfahren  
Sandabscheideanlagen (Sandfänge und Sandfanggutaufbereitungsanlagen)  
Korrespondenz Abwasser 3/98
- /37/ Kalbskopf, K.H.:



BITControl	AQUA DESIGNER 9.2 - Manual	Seite: <b>303</b> von 314
	17 Literature	Version: <b>92-00</b>

- Die Bemessung von Sandfängen unter Berücksichtigung der Strömungsturbulenzen;  
Kommunalwirtschaft 1966, Heft 9
- /38/ Martin Wagner, Peter Cornel, Stefan Krause (Darmstadt)  
Sauerstoffeintrag und  $\alpha$  -Werte in Membranbelebungsanlagen  
Korrespondenz Abwasser 11/2001
- /39/ ATV-DVWK Arbeitsblatt A 131, (2000):  
Bemessung von einstufigen Belebungsanlagen  
Gesellschaft zur Förderung der Abwassertechnik e.V.  
(GfA), Hennef
- /40/ Thomas Werner  
Beitrag zur Bemessung von einstufigen Belebungsanlagen mit Kaskadendenitrifikation  
Berichte zur Siedlungswasserwirtschaft, Nr. 9  
TU Berlin, FG Siedlungswasserwirtschaft, 1998
- /41/ N. Jardin  
Rückläufe aus der Schlammbehandlung – Menge, Beschaffenheit und Auswirkungen  
WAR Schriftenreihe Nr. 66, Verein zur Förderung des Instituts für Wasserversorgung, Abwasserbeseitigung und Raumplanung der Technischen Hochschule Darmstadt, (1993)
- /42/ ATV Arbeitsbericht 3.2  
Maschinelle Schlammwässerung  
Korrespondenz Abwasser 2/1995
- /43/ Fachausschuss KA-5 „Absetzverfahren“  
Vorklärbecken in modernen Kläranlagen  
Korrespondenz Abwasser 8/2003
- /44/ Karl und Klaus R. Imhoff  
Taschenbuch der Stadtentwässerung  
29. Auflage, 1999 R. Oldenbourg Verlag München Wien
- /45/ Rolf Kayser  
ATV-DVWK-Kommentar zum ATV-DVWK-Regelwerk  
Bemessung von Belebungs- und SBR-Anlagen  
Deutsche Vereinigung für Wasserwirtschaft, Abwasser und Abfall e.V. Hennef, 2001
- /46/ Merkblatt ATV-DVWK-M 363  
Herkunft, Aufbereitung und Verwertung von Biogas  
Deutsche Vereinigung für Wasserwirtschaft, Abwasser und Abfall e.V. Hennef, 8/2002
- /47/ Merkblatt ATV-DVWK-M 368  
Biologische Stabilisierung von Klärschlämmen  
Deutsche Vereinigung für Wasserwirtschaft, Abwasser und Abfall e.V. Hennef, 4/2003
- /48/ Rolf Otte Witte  
Rückbelastung der Kläranlage aus der Schlammbehandlung

- ATV-Handbuch Klärschlamm 4. Auflage  
Ernst & Sohn, Berlin, 1996
- /49/ Bischofsberger, Dichtl, Rosenwinkel, Seyfried, Böhnke  
Anaerobtechnik  
2. Auflage, Springer Verlag, 2005
- /50/ Henz, Harremoës, la Cour Jansen, Arvin  
Wastewater Treatment  
Biological and Chemical Processes  
Third Edition, Springer Verlag, 2002
- /51/ N.F. Gray, Biology of Wastewater Treatment,  
2<sup>nd</sup> Edition 2004, Imperial College Press
- /52/ C.W. Randall, J.L. Barnard, H.D. STensel, Water Quality Management Li-  
brary  
Volume 5: Design and Retrofit of Wastewater Treatment Plants for Biological  
Nutrient Removal  
Technomic Publishing, 1992
- /53/ Valerie Naidoo, Municipal Wastewater Characterization  
Dissertation 1999, University of Natal, Durban
- /54/ Aarne Vesilind, Wastewater Treatment Plant Design,  
Water Environment Federation, IWA Publishing, 2004
- /55/ N.F.Gray: Biology of Wastewater Treatment; 2nd Edition 2004; Imperial Col-  
lege Press
- /56/ Metcalf & Eddy: Wastewater Engineering - Treatment Disposal Reuse; 3rd  
Edition 1991; McGraw-Hill
- /57/ Merkblatt ATV-DVWK-M 198  
Vereinheitlichung und Herleitung von Bemessungswerten für Abwasseranla-  
gen  
Deutsche Vereinigung für Wasserwirtschaft, Abwasser und Abfall e.V. Hen-  
nef, 04/2003
- /58/ Arbeitsblatt DWA-A 226  
Grundsätze für die Abwasserbehandlung in Belebungsanlagen mit gemein-  
samer aerober Schlammstabilisierung ab 1.000 Einwohnerwerte  
Deutsche Vereinigung für Wasserwirtschaft, Abwasser und Abfall e.V. Hen-  
nef, 08/2009
- /59/ Merkblatt DWA-M 229-1  
Systeme zur Belüftung und Durchmischung von Belebungsanlagen  
Teil1: Planung, Ausschreibung und Ausführung  
Deutsche Vereinigung für Wasserwirtschaft, Abwasser und Abfall e.V. Hen-  
nef, Mai/2013
- /60/ Tagungsunterlagen IWAR 5  
Planung und Optimierung von Belüftungssystemen im Spiegel neuer Ent-  
wicklungen  
Verein zur Förderung des Instituts IWAR der TU Darmstadt e.V. November  
2015

BITControl	AQUA DESIGNER 9.2 - Manual	Seite: <b>305</b> von 314
	17 Literature	Version: <b>92-00</b>

- /61/ Arbeitsblatt DWA-A 216  
Energiecheck und Energieanalyse -  
Instrumente zur energieoptimierung von Abwasseranlagen  
DWA, Hennef, 2015
  
- /62/ Burkhard Teichgräber und Martin Hetschel (Essen)  
Bemessung der einstufigen biologischen Abwasserreinigung nach DWA-A 131  
Korrespondenz Abwasser, Abfall , GFA, Hennef, 02/2016
  
- /63/ Wichern et. al.  
Hinweise für die Bemessung von Belebungsanlagen im Ausland auf Basis des Ar-  
beitsblatts DWA-A 131  
Korrespondenz Abwasser, Abfall, GFA, Hennef, 08/2017
  
- /64/ DWA-Themen T4/2016  
Bemessung von Kläranlagen in warmen und kalten Klimazonen  
DWA, Hennef, 2015
  
- /65/ Malaysian Sewerage Industry Guidelines  
Sewage Treatment Plants  
National Water Services Commission (SPAN), Third Edition, 2009
  
- /66/ Merkblatt DWA-M 227  
Membran-Bioreaktor-Verfahren (MBR-Verfahren)  
DWA, Hennef, 2014
  
- /67/ DIN 19558  
Ablaufeinrichtungen, Überfallwehr und Tauchwand, getauchte Ablaufrohre  
in Becken, Baugrundsätze, Hauptmaße, Anordnungsbeispiele  
Normenausschuss Wasserwesen im DIN, Berlin, 2002
  
- /68/ Christoph Thiemig, Dissertation  
Die Bedeutung der Filtrationseigenschaften von belebten Schlämmen beim Betrieb  
von Membranbioreaktoren  
D82 (Diss. RWTH Aachen University, 2011)  
Ges. z. Förderung d. Siedlungswasserwirtschaft an der RWTH Aachen e.V, Gewäs-  
serschutz - Wasser - Abwasser (GWA), Band 226, Aachen, 2011
  
- /69/ Simone Meuler-List, Dissertation  
Foulingverhalten einer kommunalen MBR-Anlage  
Institut für Wasser und Gewässerentwicklung, Fachbereich Siedlungswasserwirt-  
schaft und Wassergütewirtschaft, KIT – Die Forschungsuniversität in der Helmholtz  
Gesellschaft, Karlsruhe 2019

**Fehler! Verweisquelle konnte nicht gefunden werden.Fehler! Verweisquelle konnte nicht gefunden werden.**

Index	
Aanaerobic tank.....	44
Abwasserzufluss	
Metcalf & Eddy .....	53
MSIG .....	53
Activated chamber	
separate .....	149
Activated sludge plant.....	96
Activated sludge process	
theory .....	37
Activated sludge tank.....	143
activated chamber .....	27
minimum diameter .....	147
tank proportions.....	28
true volume.....	148
Actual volume .....	94
Aerated grit chamber .....	244
<b>Aeration</b> .....	28
dimensioning temperature .....	165
loading condition.....	165
Aeration lattice	
construction .....	175
header pipes.....	171
Aeration lattices .....	170
Aeration period .....	98
aeration pulses .....	177
Aerator disc .....	170
Aerator load .....	173, 174
Aerobic selector .....	119
Air consumption .....	153
Air volume	
hourly .....	168
AlCl <sub>3</sub> .....	45
Aluminium.....	89, 102
Aluminium chloride .....	102
Ammonia .....	42
Ammonia nitrogen in effluent .....	96
Ammonification .....	42
Anaerobic phase.....	44
Anaerobic stabilization of sludge...	229
Ardern.....	39
Atomic masses.....	103
ATV A131	
qsv vertikal.....	125
ATV A131 guideline .....	127
ATV guidelines .....	61
ATV worksheets .....	46
ATV-Committee 2.12.....	249
ATV-Fachausschuss 2.12 .....	249
Autotrophic bacteria .....	43
Belastung	
Metcalf & Eddy.....	53
MSIG .....	53
Bemessung	
MSIG .....	115
Biodegradation .....	41
Biological association .....	40
Biological excess sludge production	92
Biologically active micro-organisms	39
Biologically removed phosphorus.	101
Blower.....	169
room temperature .....	224
BOD <sub>5</sub> .....	50
BOD <sub>5</sub> -sludge load.....	40
Bouyancy .....	270
Buffer capacity .....	43
Cascaded denitrification .....	73
Centrifugal fan.....	178
Chemical precipitation .....	45
Clarified water outlet .....	141
Clear water zone.....	130, 134
Combined heat and power unit....	229
combined mixing and aeration.....	177
Compact plant	
scaled drawing.....	148
Comparative window .....	124
Comparing sedimentation tanks...	281
Completed dimensioning.....	15
Component selection.....	241
Compressor .....	217
Conformity.....	94

Control box.....	17	zoom .....	261
<b>Control graph</b> .....	28, 149	DWA A 226 guideline.....	62, 124
Conventions .....	9	DWA-A 216 .....	312
Counter pressure .....	217	Energy consumption .....	166
Cross Flow .....	185	Energy input .....	178
Cycle period .....	189	English .....	46
<b>Databank</b> .....	28, 211	Enhanced biological uptake .....	44
air lift pump .....	217, 218	Equation for the denitrification .....	44
<b>blower</b> .....	28, 217	Eutrophic waters.....	43
further data .....	212	Excess sludge .....	41, 103
mixer.....	215	production .....	90, 92, 110, 112
mixing devices .....	215	volume .....	249
new data .....	212	Extension.....	33
pumps.....	213	Extern-C-dosage	
save data .....	212	calculation .....	82
transport capacity.....	213	carbon sources.....	79
Deep secondary sedimentation ....	147	infliction .....	79
Denitrification .....	96, 97, 98	milieu.....	80
cascaded .....	73	pH .....	82
Denitrification process .....	157	precipitent.....	84
<b>Description</b> .....	34, 221	temperatur.....	81
Design temperature.....	96	FeCl <sub>3</sub> .....	45
Desinfektion .....	188	Fermenter temperature.....	232
Detention time .....	40	Filamentous bacteria .....	119
Diameter .....	126	File name.....	12
<b>Dimensioning</b> .....	35, 46	Filterable solids.....	50
Dimensioning temperature .....	165	Flocculant.....	228
Disc aerator		Floor level.....	145
diameter.....	174	flow diagram .....	266
load.....	174	export .....	267
Disposal costs .....	249	Flow distance.....	132
Disposal of grit and grease.....	249	flow sheme .....	266
Disposal of screenings .....	249	Free boards .....	260
Double-sided overflow weir .....	143	Friction rectangle .....	270
Drawing.....	35, 256	German .....	46
aeration system.....	264	Gravitational thickening .....	228
export.....	265	Grease .....	248
print.....	265	separator .....	244
drawings		volume .....	248
export.....	263	Grit	
tools .....	261	chamber scraper .....	244

classifier .....	248	Layout	
classifier operation period .....	244	concentrations.....	223
dewatering .....	248	dry weather flow .....	223
transport .....	244	scroll bar .....	220
Growth rate .....	39, 41	title page .....	221
Guidelines .....	46	Lime conditioning .....	40
H <sup>+</sup> -Ion .....	43	Links .....	15
Header pipes .....	261	Liquid depth .....	130
Heat removal .....	224	Liquid level zones.....	133
Heterotrophic micro-organism ...	41, 43	<u>Load</u> .....	47
High loaded peak .....	242	for organic.....	50
Hopper angle .....	135, 137	industrial .....	47
Hopper bottom tank .....	122, 123, 135	industriell inflow.....	59
Horizontal flow secondary sedimentation tank .....	127	specific.....	50
Horizontal flow tanks.....	123	Loading conditions	
Hydrolysis .....	41	aeration.....	165
Immersed pipes .....	141	Lockett .....	39
Immersion depth .....	169	Main window .....	14
impulse aeration .....	177	Mass calculation.....	267
Inactive particles .....	111	MBR.....	181
Industrial .....	59	Construction.....	181
Inflow level.....	129	Cross Flow.....	185
Inlet chamber .....	129	Design .....	187
Inorganic carbon .....	43	Permeatpumpen .....	186
Inorganic polyphosphates .....	44	Process Variants.....	181
Input field .....	16	Recirculation .....	183
Insoluble organic substances.....	41	Return Sludge.....	183
Installation .....	10	Mechanical thickening .....	40
Intermitted denitrification		Membranbelebung	
cascaded .....	73	Desinfektion .....	188
Intermittent denitrification .....	46	<b>Membrane aeration</b> .....	170
Internal response .....	57	aerator disc.....	170
Invert .....	134	tubular diffuser .....	170
Iron .....	89, 102	Membrane Bioreactor.....	181
Iron(III)-chloride .....	102	<b>Menu bar</b> .....	12
ISV.....	89	Metabolic turnover.....	39
Keyboard function.....	17	Metal mass.....	103
Kontakt .....	312	Minimum heights.....	132
<b>Language</b> .....	12, 46	Mixed liquor suspended solids ..	90, 91
Law of the minimum.....	42	Mixing .....	176, 177
		impulse aeration.....	177

Mixing devices.....	46, 98	Oxygen supply.....	167
MLSS		factor .....	166
influent .....	90	hourly .....	167
sludge treatment .....	289	Oxygen transfer .....	166
Molar ratio .....	102, 103	Oxygen transfer capacity	
MSIG.....	115	surface aeration.....	179
N <sub>2</sub> O .....	43	Oxygenation	
New project .....	20	surface aeration.....	178
<b>Nitrate-N</b> .....	96	<i>Package plant</i> .....	144, 145
Nitrification .....	96, 97	Partial stabilisation.....	91
Nitrobacter .....	43	Path name .....	12
Nitrogen .....	50	P-content.....	44
deficiency .....	42	Permeatpumpen .....	186
elimination.....	46	Personnel costs .....	249
load.....	96	Personnel requirement .....	249
Nitrosomonas .....	43	Phosphate .....	50
Non vegetation time .....	228	aluminium salt .....	103, 104
Nutrient ratio.....	42	biological phosphorus removal ...	99
Operating cost calculation .....	241	iron salt.....	103
Operation building .....	221	precipitation.....	104
Operation period .....	244	removal .....	98
Operation period of screen .....	244	Phosphorus .....	44
Option field.....	16	precipitant requirement.....	102
Organic load.....	88	simultaneous precipitation .....	102
Organic phosphorus .....	44	Plant efficiency .....	243
Orthophosphate .....	44	Polyphosphate.....	44
Outflow.....	221	Pöpel .....	166
Outlet channels .....	142	<b>Population equivalent</b> 22, 46, 48, 50	
Outlet pipe.....	225	Power consumption .....	35
Overflow weirs.....	142	Pre sedimentation.....	60
Oxidation.....	43	retention time.....	60
Oxidation of ammonia .....	157	Precipitant application.....	102
Oxygen charge.....	157	Precipitation sludge .....	111
Oxygen concentration .....	157, 166	Preliminary clarification.....	243
Oxygen demand.....	153, 156, 168	Preliminary step.....	50
specific.....	156	Presentation .....	34
Oxygen Demand		Pretreatment step .....	221
SBR .....	196	Primary sedimentation .....	50
Oxygen efficiency .....	252	Project name .....	21
Oxygen requirements .....	43, 97	pulse aeration.....	177
Oxygen saturation concentration ..	158	Pumping stations .....	241

<b>Pumps</b>	design .....	121
capacity .....	mixing .....	121
<b>centrifugal</b> .....	Separate sewerage system .....	243
power consumption .....	Separate stage denitrification	
pumping head .....	cascaded .....	75
Pure nitrification .....	Sequencing Batch Reactors .....	189
<b>qSV</b> .....	Settleability .....	89
Rain frequency .....	Settling zone .....	130
Recirculation ratio .....	Sewer system, combined .....	242
A131 .....	Shock factors .....	157
Reduction of nitrate .....	Side view .....	265
Reproduction time .....	Single-sided overflow weir .....	143
<b>Return sludge transportation</b> .....	Siphon pipe .....	225
Returned biomass .....	Slope .....	269
Rotary piston blower .....	Sludge	
Rotting process .....	age .....	91
SAE	buoyancy .....	132
air demand .....	detention period .....	228
membrane aeration .....	detention time .....	33
mixers .....	load .....	40, 91
surface aeration .....	load, A 226 .....	91, 93
Safety .....	production .....	41
SBR .....	scraper .....	131
Cycle Period .....	stabilisation .....	91
exchange volume .....	tank .....	33, 227
Oxygen Demand .....	tank, specific energy .....	229
Reactor Volume .....	thickening .....	33
Sedimentation .....	withdrawal pipes .....	131
volume exchange ratio .....	Sludge treatment .....	226, 227
Scraping zone .....	combined heat and power unit ..	229
Screenings	range of application .....	229
press .....	Sludge volume index .....	88, 89
volume .....	Sludge volume surface loading ....	125
<b>Secondary sedimentation tank</b> .....	Solids concentration in the return	
281	sludge .....	131
extern .....	Solids Loading Rate	
variations .....	M&E .....	139
variations .....	MSIG .....	139
Sedimentation .....	Specific heat capacity .....	224
Selector .....	Specific operation costs .....	250
aeration .....	Spur .....	270



Square grit chamber.....	244	Time switch .....	44
Stability .....	40	<b>Title bar</b> .....	12, 35
Stabilizing of sludge		TKN .....	50
anaerobic .....	229	Top view .....	265
<b>Staff</b> .....	35	Total depth .....	135
Standard aeration efficiency .....	252	Total excess sludge production .....	93
Standard values .....	260	Total sludge production .....	104
Start .....	10	Trade .....	59
Storage tank.....	242	Trade load .....	88
Storage zone.....	129, 131	Transfer of oxygen.....	157
Supernatant		True scaled drawings.....	256
concentrations.....	58	Tubular diffuser.....	167, 170
loads .....	58	Un aerated phase .....	44
Support .....	312	Upflow aerobic selector .....	119
Surface loading rate .....	125	Urea .....	42
Surface Overflow Rate		Variations of wastewater.....	40
M&E.....	139	Vertical flow sedimentation tank ..	122, 125, 137
MSIG.....	139	Vertrieb.....	312
System requirements .....	10	VN/V-ratio.....	112
Tank		Volume activated sludge tank	
design .....	135	A131.....	94
geometry.....	143	volume exchange ratio.....	192
volume .....	39	Volume flow .....	243
Temperature.....	165	Volumetric loading .....	91
Thermal efficiency .....	224	Wastewater inflow .....	223
Thickener .....	226	Water depth.....	145
Thickening and scraping zone .....	131	Weir load .....	142
Thickening detention period ..	131, 132	Work space .....	268
Thickening, gravitational.....	227		

# 18Service

# BITControl

is more than Hard- and Software

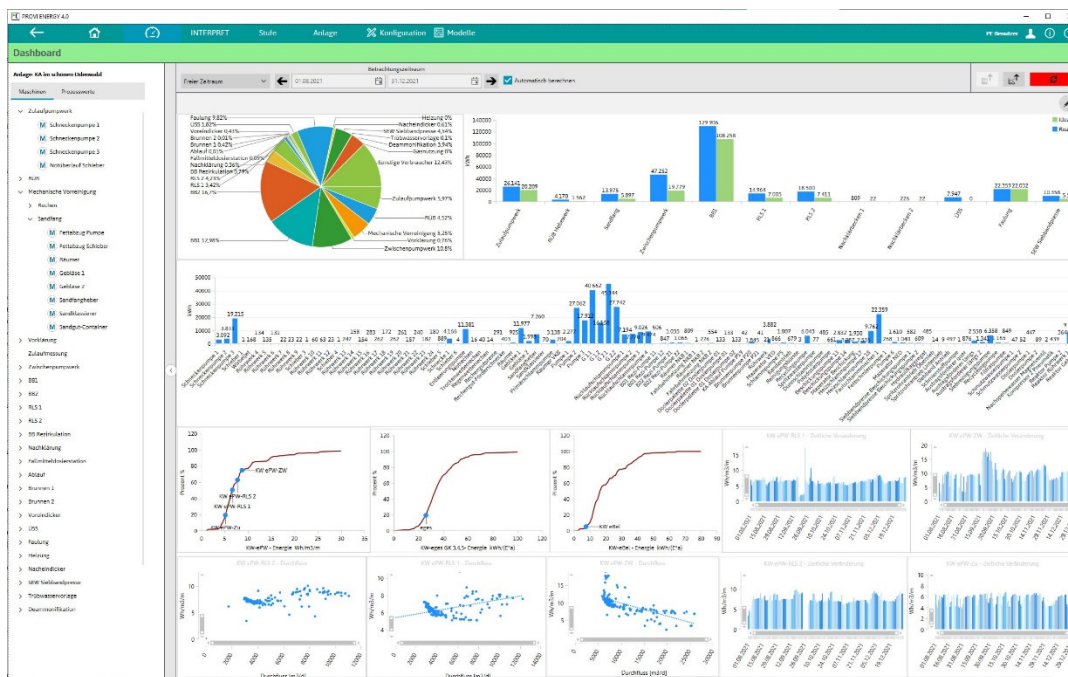

Our range of services:

- Software for planning of wastewater treatment plants: AQUA DESIGNER
- Software for economic design of aeration systems: AQUA AERO
- Process control and remote control technology for waste water, water treatment and biogas: AQUA BIO and PROVI
- Online documentation systems: PROFESSIONAL ONLINE
- Online Backup: PROVI BACKUP
- Online Energy Analysis According to the DWA-A 216
- Consulting services for mechanical and electrical engineering
- Process studies of energy efficiency and optimization of wastewater treatment plants

BITControl GmbH, Auf dem Sauerfeld 20, 54636 Nattenheim  
Germany

Telefon: +49 65 69 / 962 55-11

Telefax: +49 65 69 / 962 55-19